

# TM 9-1829A

TO 19-75E-1

WAR DEPARTMENT TECHNICAL MANUAL

---

ORDNANCE MAINTENANCE

## SPEEDOMETERS, TACHOMETERS, AND RECORDERS

---

**WAR DEPARTMENT**

*http://jeepdraw.com  
FREE DOWNLOAD  
Thanks to G503.com  
Jon Rogers & Pete Silven*

**APRIL 1944**

**WAR DEPARTMENT TECHNICAL MANUAL**

**TM 9-1829A**

---

**ORDNANCE MAINTENANCE  
SPEEDOMETERS, TACHOMETERS,  
AND RECORDERS**



**WAR DEPARTMENT**

**April 1944**

---

**WAR DEPARTMENT**  
**Washington 25, D. C., 15 April 1944**

TM 9-1829A, Ordnance Maintenance: Speedometers, Tachometers, and Recorders, is published for the information and guidance of all concerned.

[A. G. 300.7 (7 Dec 43)]

**BY ORDER OF THE SECRETARY OF WAR:**

**G. C. MARSHALL,**  
*Chief of Staff.*

**OFFICIAL:**

**J. A. ULIO,**  
*Major General,*  
*The Adjutant General.*

**DISTRIBUTION:** As prescribed in paragraph 9 a, FM 21-6; I Bn 9 (2); I C 5 (5); I C 9 (4).

**I Bn 9:** T/O & E 9-325, Ord Base Auto Maint Bn.

**I C 5:** T/O & E 5-357, Engr Hv Shop Co; T/O & E 5-367, Engr L Equip Co; T/O & E 5-377, Engr Base Equip Co.

**I C 9:** T/O & E 9-327, Ord Base Auto Maint Co (Engine Rebuild) or Co, Ord Base Auto Maint Bn.

(For explanation of symbols, see FM 21-6.)

*http://jeepdraw.com*  
*FREE DOWNLOAD*  
*Thanks to G503.com*  
*Jon Rogers & Pete Silfven*

**CONTENTS**

*http://jeepdraw.com  
FREE DOWNLOAD  
Thanks to G503.com  
Jon Rogers & Pete Silfven*

		<b>Paragraphs</b>	<b>Pages</b>
<b>CHAPTER</b>	1. Introduction .....	1	4
<b>CHAPTER</b>	2. Magnetic-type speedometers and tachometers; description, operation, identification, and testing	2-4	5-16
<b>CHAPTER</b>	3. AC division of General Motors speedometers and tachometers	5-9	17-30
<b>CHAPTER</b>	4. Auto-Lite speedometers and tachometers .....	10-22	31-57
<b>SECTION</b>	I SPA series .....	10-14	31-44
	II SPJ, SPL, and SPM series .....	15-18	45-49
	III SPK, SPP, and SPR series .....	19-22	50-57
<b>CHAPTER</b>	5. King-Seeley speedometers .....	23-27	58-66
<b>CHAPTER</b>	6. Stewart-Warner speedometers and tachometers .....	28-40	67-120
<b>SECTION</b>	I Speedometers with cup-type magnets .....	28-31	67-88
	II Speedometers and tachometers with flat disk-type magnets ...	32-35	89-109
	III Centrifugal tachometers (Type 424) .....	36-40	110-120
<b>CHAPTER</b>	7. Waltham speedometers .....	41-44	121-125
<b>CHAPTER</b>	8. Stewart-Warner recorders (including hourmeters) .....	45-49	126-131
<b>CHAPTER</b>	9. Flexible shafts .....	50-52	132-139
<b>CHAPTER</b>	10. AC speed adapters .....	53-55	140-141
<b>CHAPTER</b>	11. Stewart-Warner drive joints ....	56-63	142-152
<b>SECTION</b>	I 666-type drive joints .....	56-60	142-150
	II 659-type drive joints .....	61-63	151-152
<b>CHAPTER</b>	12. Special tools .....	64	153-157
<b>CHAPTER</b>	13. Calibrating machine .....	65-68	158-161
<b>REFERENCES</b>	.....		162
<b>INDEX</b>	.....		163

# ORDNANCE MAINTENANCE SPEEDOMETERS, TACHOMETERS, AND RECORDERS

## CHAPTER 1 INTRODUCTION

*http://jeepdraw.com  
FREE DOWNLOAD  
Thanks to G503.com  
Jon Rogers & Pete Silfven*

### 1. PURPOSE AND SCOPE.

a. The instructions contained in this manual are for the information and guidance of personnel charged with the repair and rebuilding of speedometers, tachometers, recorders, and related drive equipment. These instructions are supplementary to those in the field manuals and technical manuals prepared for the using arms. This manual does not contain information which is intended primarily for the using arms, since such information is available to ordnance maintenance personnel in 100-series TM's or FM's.

b. This manual contains a description of, and procedure for testing, disassembly, cleaning, inspection, and assembly of all makes of speedometers, tachometers, recorders (including hourmeters), flexible shafts, and drive joints.

c. For instructions for removal and replacement of instruments, etc., on vehicles, refer to pertinent operator's manual 100-series TM's.

## CHAPTER 2

## MAGNETIC-TYPE SPEEDOMETERS AND TACHOMETERS; DESCRIPTION, OPERATION, IDENTIFICATION, AND TESTING

### 2. DESCRIPTION AND OPERATION.

a. **Description.** All makes of magnetic-type speedometers and tachometers are similar in outward appearance, having a case, bezel, glass, pointer, and face dial. (Where the bezel and glass are assembled in the instrument panel, these parts are not attached to the speedometer itself.)

(1) **SPEEDOMETER.** A speedometer (fig. 1) is used to indicate vehicle speed in miles per hour as shown by the pointer and face dial, and to record distance traveled by means of an odometer. A

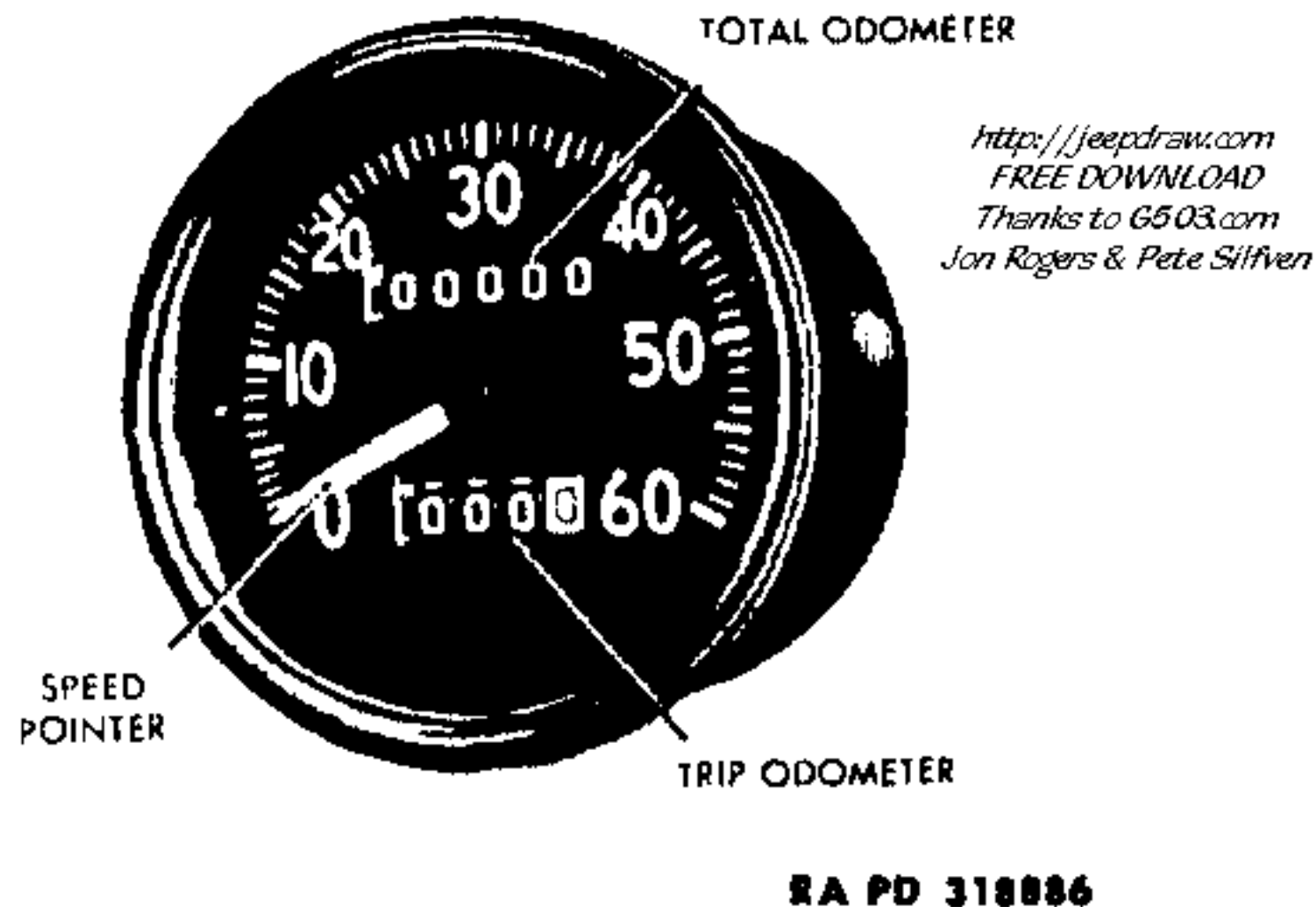

RA PD 318886

**Figure 1—Speedometer**

speedometer is driven through a flexible shaft connected to a set of gears in the vehicle transmission (fig. 2). These gears are designed for the particular vehicle model and take into consideration the tire size and rear axle ratio. The flexible shaft, which connects the transmission driven gear to the speedometer, consists of an outer casing and the inner drive core (fig. 3). The total odometer usually records up to 99,999 miles before it automatically returns to zero. The trip odometer usually registers up to 999.9 miles, but by means of the trip reset it can be reset to zero or any intermediate figure desired. Some speedometers are not equipped with a trip odometer. These units have an extra wheel or tenth dial at the right of the total odometer.

(2) **TACHOMETER.** A magnetic-type tachometer (fig. 4) is similar to a speedometer, except that the face dial indicates in revolutions per minute (instead of miles per hour) and is ordinarily used to indicate vehicle engine speed. A tachometer is driven through a flex-

**ORDNANCE MAINTENANCE  
 SPEEDOMETERS, TACHOMETERS, AND RECORDERS**

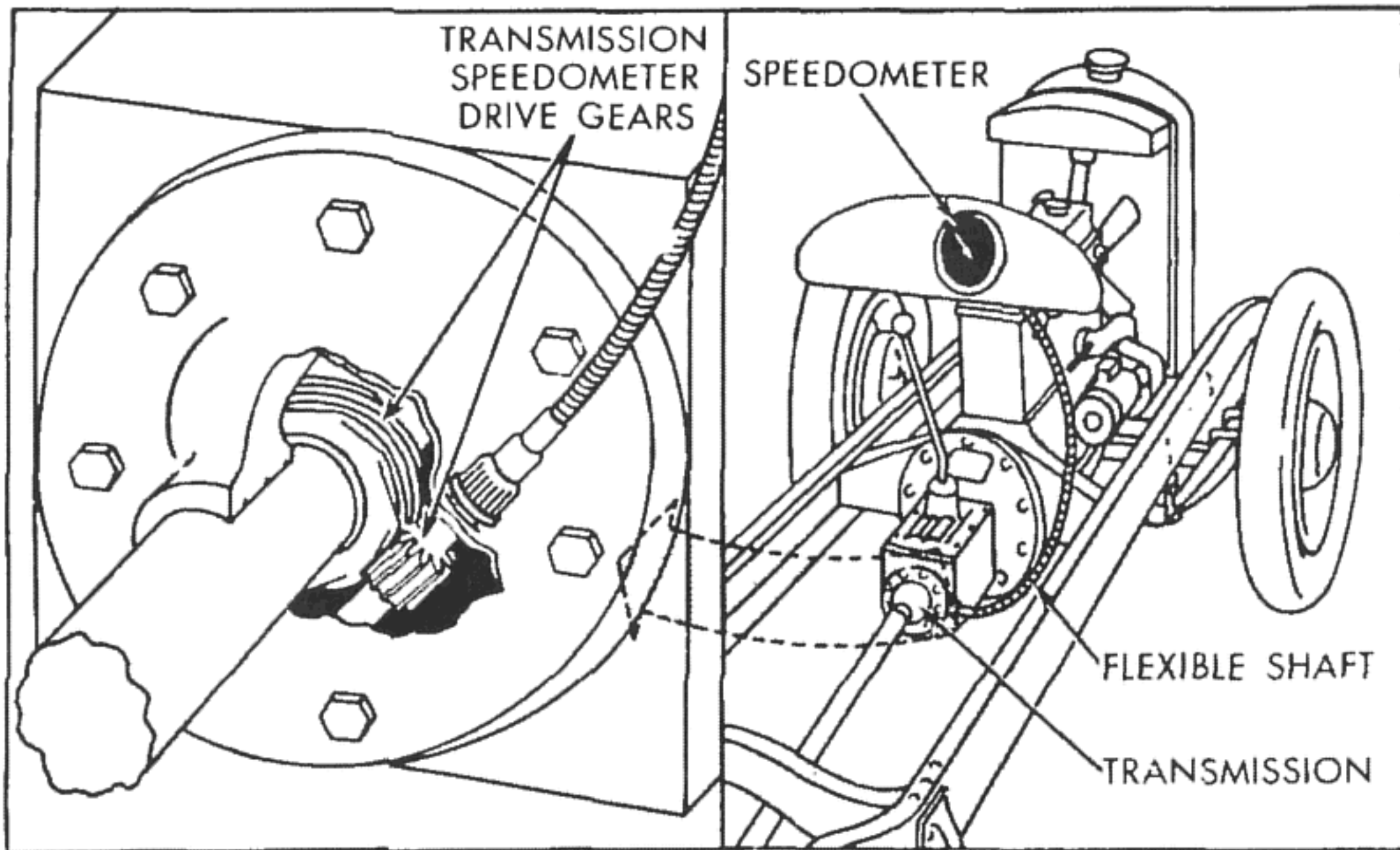

RA PD 318887

**Figure 2—Speedometer Installation**

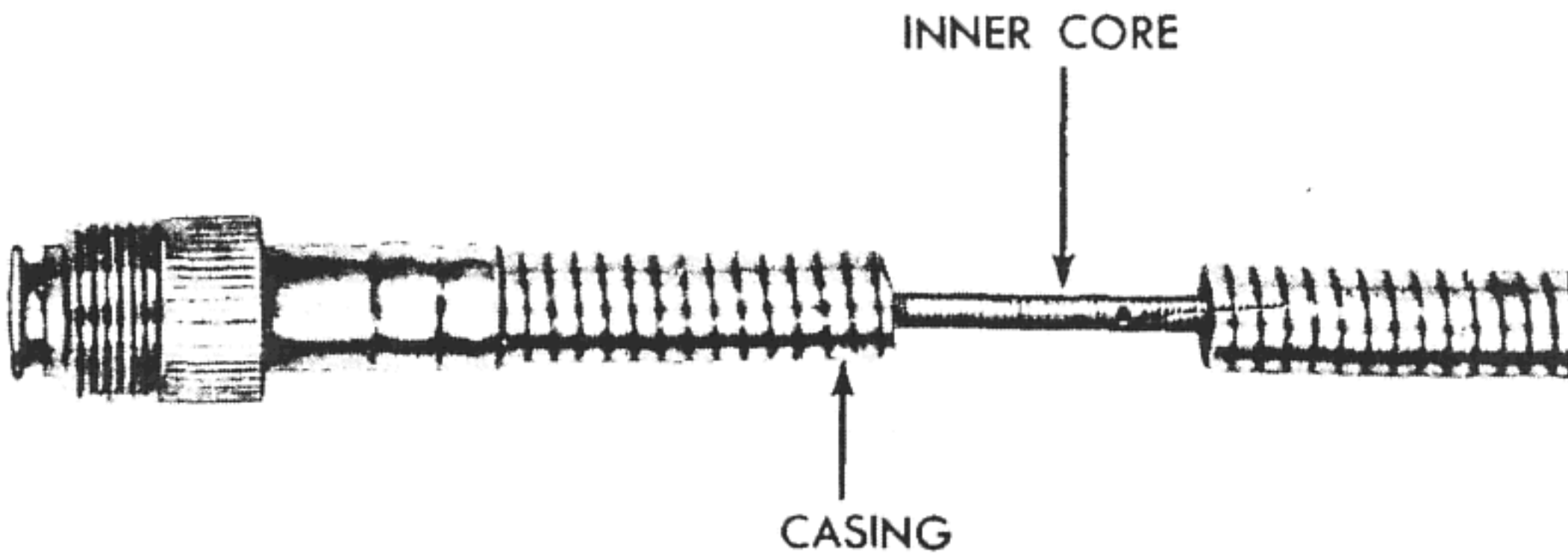

RA PD 318888

**Figure 3—Flexible Shaft**

ible shaft which is usually connected to the vehicle generator shaft, crankshaft, or distributor shaft by means of a drive joint or adapter. An odometer is often incorporated in a tachometer to record total revolutions.

**b. Operation.** Even though the internal parts of the various make magnetic-type instruments vary in construction and appearance, they

## MAGNETIC-TYPE SPEEDOMETERS AND TACHOMETERS; DESCRIPTION, OPERATION, IDENTIFICATION, AND TESTING

all incorporate the same basic components (as described below) and operate on the same principles.

(1) **SPEED INDICATION** (fig. 5). The speed-indicating portion of a speedometer or tachometer of the magnetic-type operates on the magnetic principle, and includes a revolving permanent magnet (driven by the flexible shaft). Around this revolving permanent magnet is a stationary field plate. (Some Auto-Lite instruments have a revolving field plate). Between the magnet and field plate is a movable speed cup, with the indicating pointer attached to the end of the speed cup staff. The magnet revolves within the speed cup. The revolving magnet sets up a rotating magnetic field which exerts a pull or magnetic drag on the speed cup, making it revolve in the same direction. The movement of the speed cup is retarded and held steady

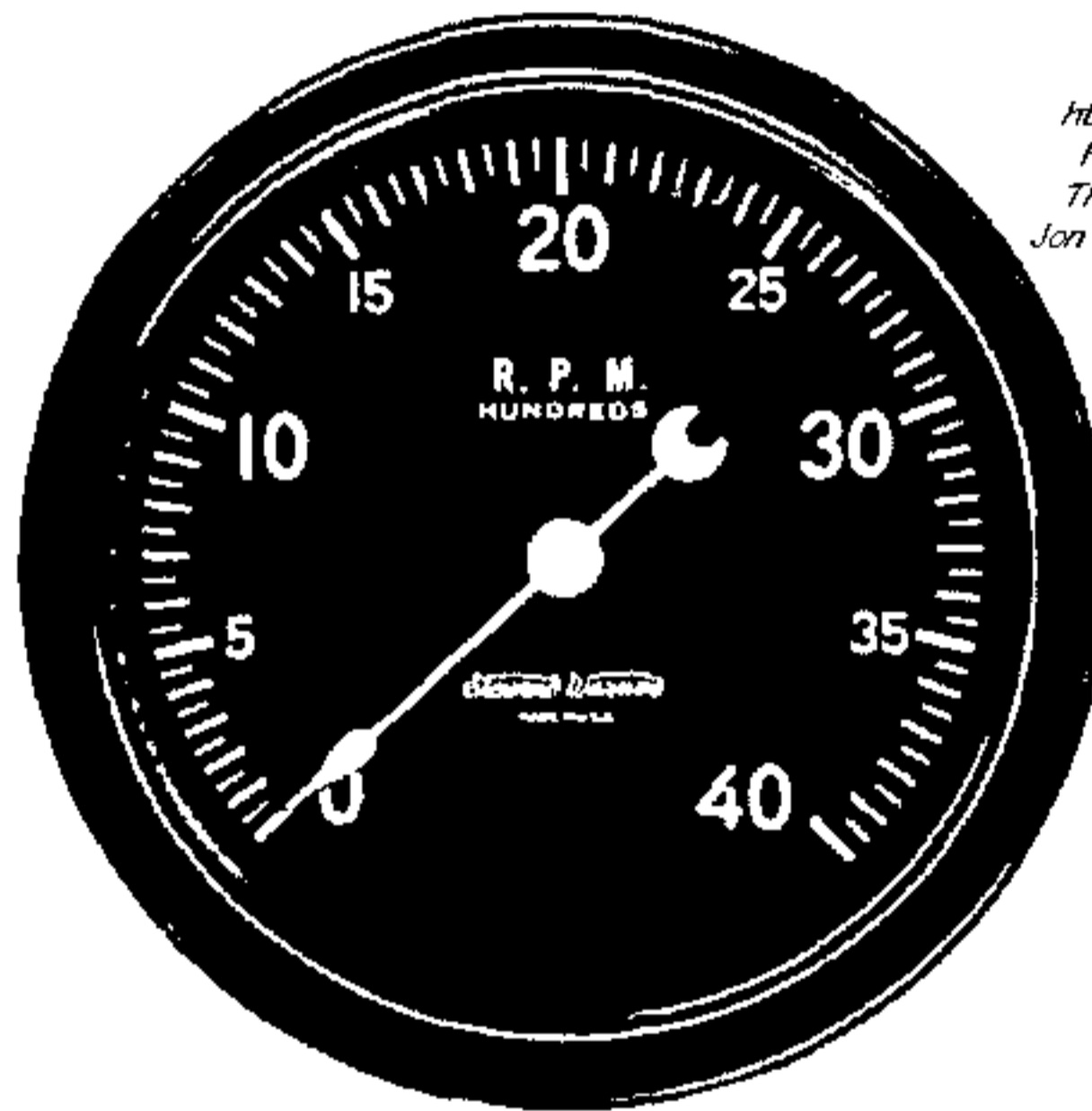

RA PD 318889

**Figure 4—Tachometer**

by a hair spring attached to the speed cup staff. The speed cup comes to rest at a point where the magnetic drag is just balanced by the retarding force created by the hair spring. An additional function of the hair spring is to pull the pointer back to zero when the vehicle or engine stops. There is no mechanical connection between the revolving magnet and the speed cup. As the speed of the magnet increases due to vehicle acceleration or (as in the case of a tachometer) increase in the engine speed, the magnetic drag on the speed cup also increases and pulls the speed cup further around, thus registering a faster speed by the pointer and face dial. The magnetic field is constant, and the amount of speed cup deflection is at all times proportionate to the speed at which the magnet is being revolved.



**ORDNANCE MAINTENANCE  
 SPEEDOMETERS, TACHOMETERS, AND RECORDERS**

(2) ODOMETER OPERATION.

(a) *Total Odometer* (fig. 7). The total odometer is driven through a series of gears originating at a spiral gear cut on the magnet shaft. This gear, known as the "first gear," drives an intermediate "second gear" and "third gear" which is connected to a "fourth gear" at the odometer. The "fourth gear" turns the odometer through a series of "star pinion" gears inside the odometer dials or figure wheels. The

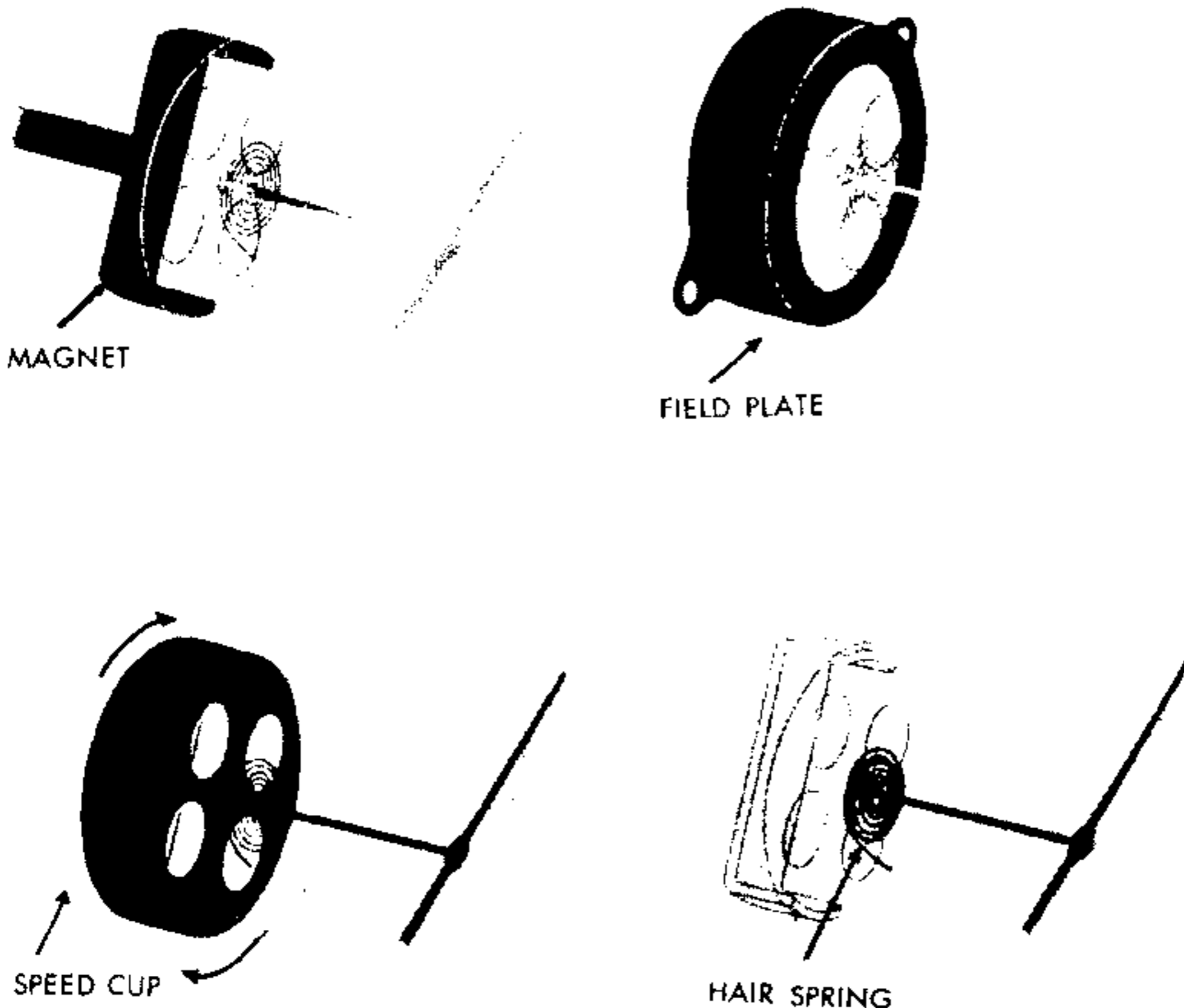

RA PD 318890

**Figure 5—Phantom View of Basic Components of Speed-Indicating Portion of Speedometer**

total odometer usually has five figure wheels or dials, and is so constructed and geared that as any one wheel finishes a complete revolution it turns the next figure wheel to the left  $\frac{1}{10}$  of a revolution.

(b) *Trip Odometer* (fig. 8). The trip odometer is also driven by the "third gear," through the trip odometer drive gear, and another gear at the trip odometer. The trip odometer usually has four figure wheels, and is so constructed that as any one figure wheel finishes a

## MAGNETIC-TYPE SPEEDOMETERS AND TACHOMETERS; DESCRIPTION, OPERATION, IDENTIFICATION, AND TESTING

complete revolution, it turns the next figure wheel to the left  $\frac{1}{10}$  of a revolution. The figure wheel on the extreme right registers in tenths of a mile. The trip odometer is usually equipped with a reset mechanism so that the mileage on the trip odometer can be reset as desired.

### 3. IDENTIFICATION.

a. **Purpose.** Before starting the actual repair of a speedometer or tachometer, it is necessary to determine its original manufacturer,

*http://jeepdraw.com  
FREE DOWNLOAD  
Thanks to G503.com  
Jon Rogers & Pete Silfven*

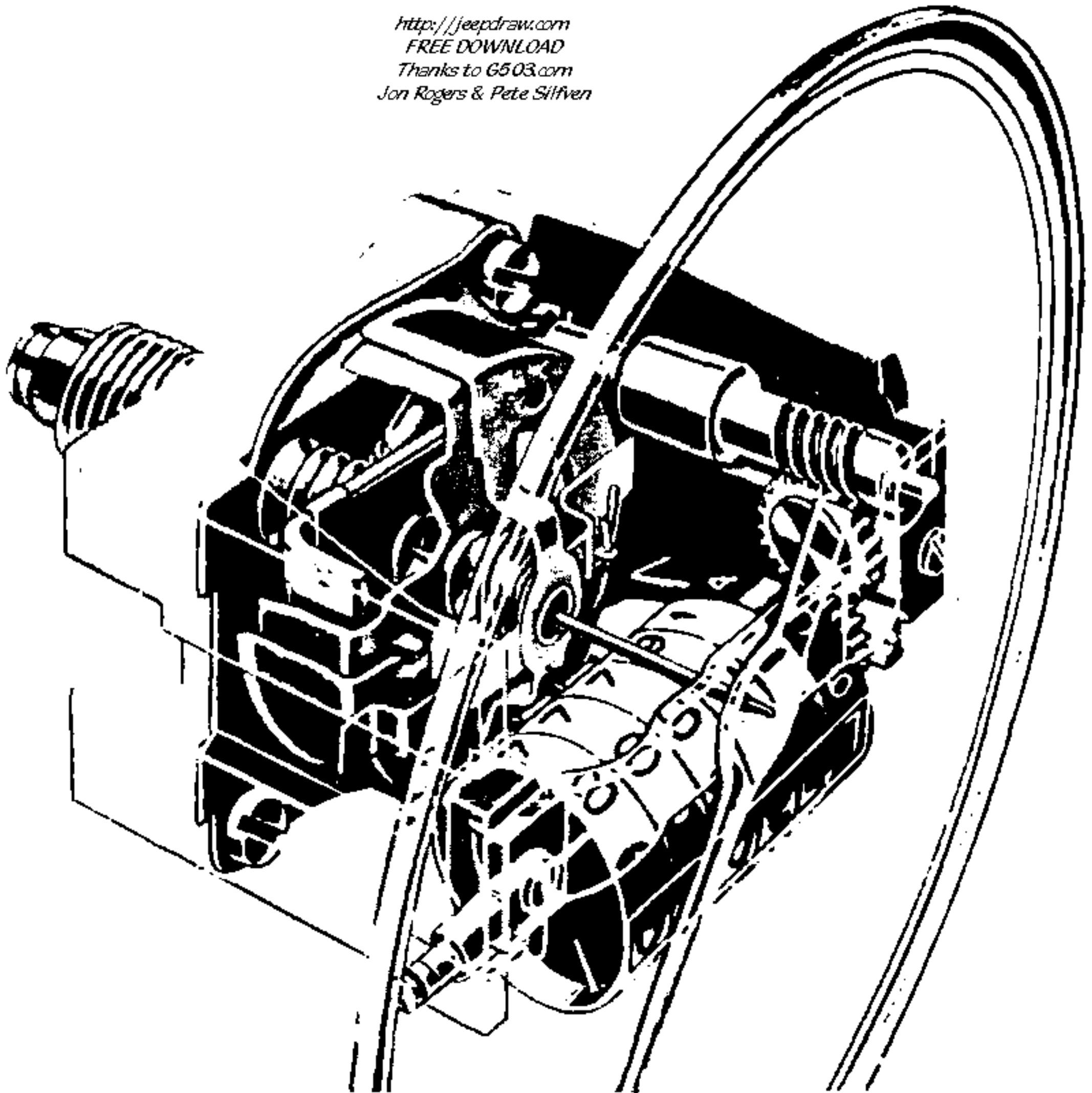

RA PD 318891

**Figure 6—Phantom View of Speedometer**

so that the proper chapter of this manual may be referred to for instructions.

#### b. Methods of Identifying Instrument Manufacturer.

(1) "AC." Company name—"AC Spark Plug, Flint, Michigan"

**ORDNANCE MAINTENANCE  
 SPEEDOMETERS, TACHOMETERS, AND RECORDERS**

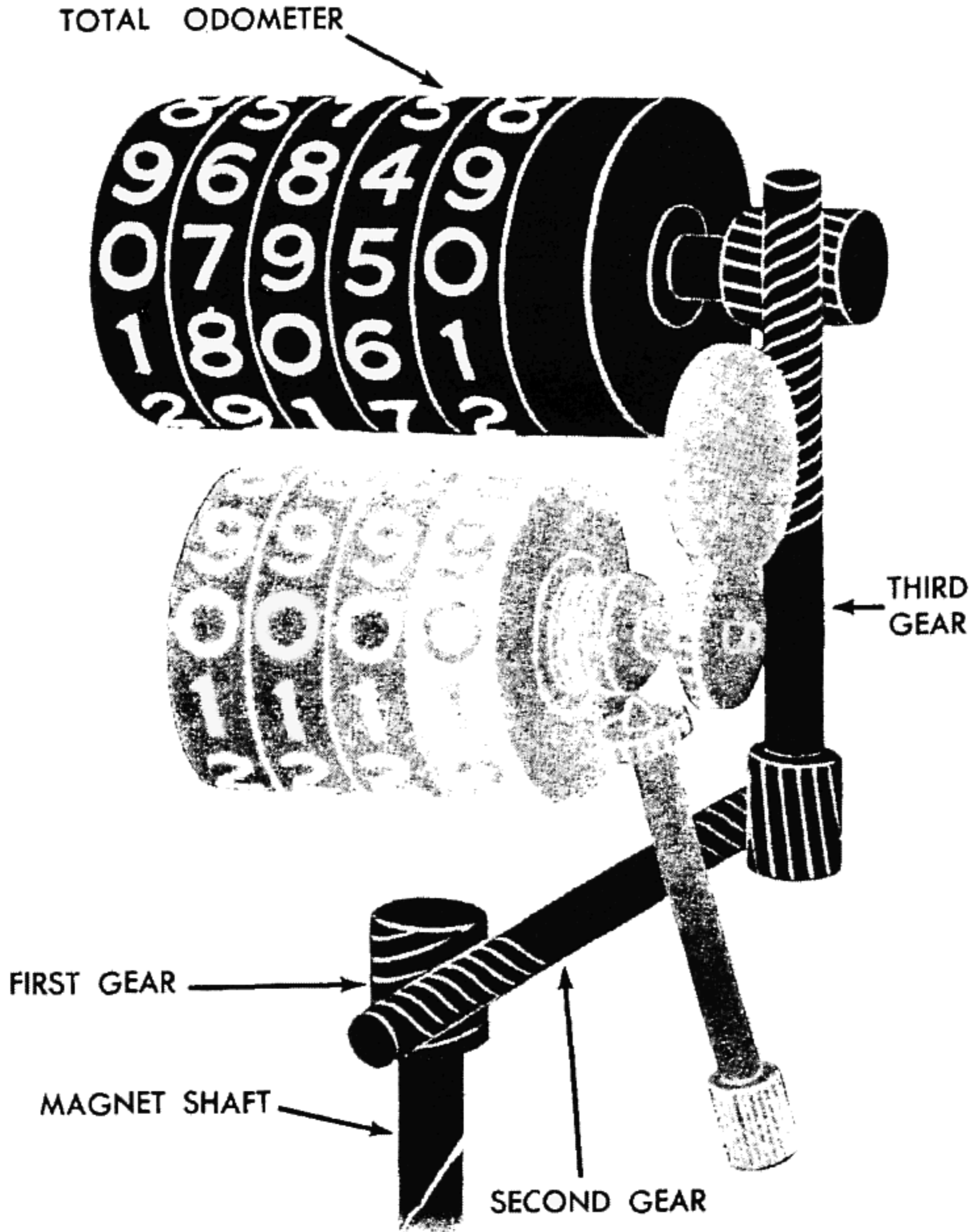

RA PD 318892

**Figure 7—Schematic View of Total Odometer**

stamped on rear of case (fig. 9). A part number, by which service parts are determined, is always stenciled on the case. This number will look like this: "1567101 B-206576" or new stamping as "1567470-6208454." The first number is the "AC" identification, and the second is the applicable ordnance number.

(2) **AUTO-LITE.** Part number or "Motometer G & E Division, La Crosse, Wisconsin, USA" stamped on rear of case (fig. 10).

## MAGNETIC-TYPE SPEEDOMETERS AND TACHOMETERS; DESCRIPTION, OPERATION, IDENTIFICATION, AND TESTING

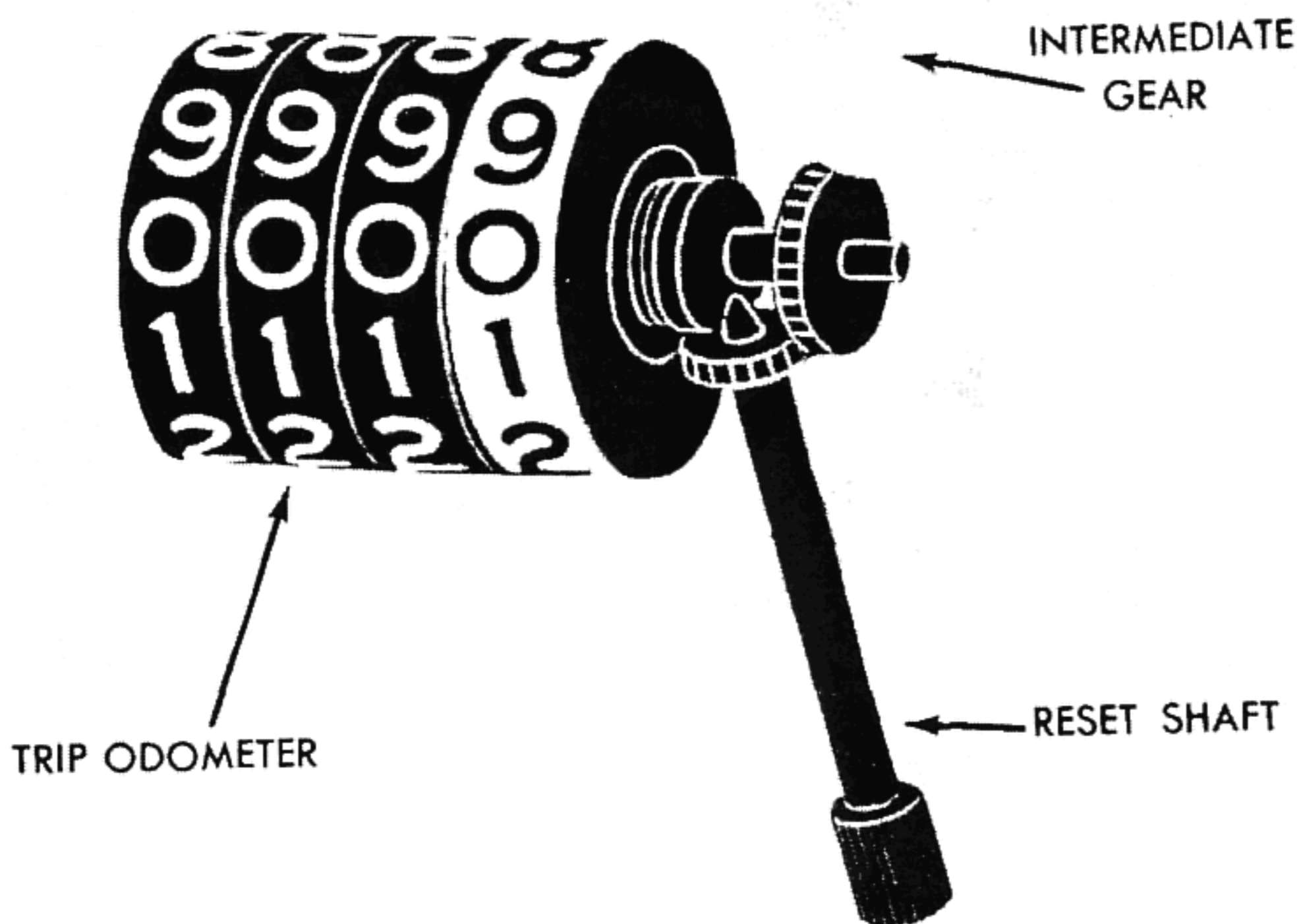

RA PD 318893

**Figure 8—Schematic View of Trip Odometer**

(3) **KING-SEELEY.** Letters "KS" preceding the part number of face dial and stamped in rear of case (fig. 11).

(4) **STEWART-WARNER.** Part number stamped on the back of the case (fig. 12), by the letters "SW" preceding the part number of the face dial, or by the name "Stewart-Warner" on the face dial.

(5) **WALTHAM.** Marking at bottom of face dial reading "Waltham, made in USA" (fig. 13).

**ORDNANCE MAINTENANCE  
SPEEDOMETERS, TACHOMETERS, AND RECORDERS**

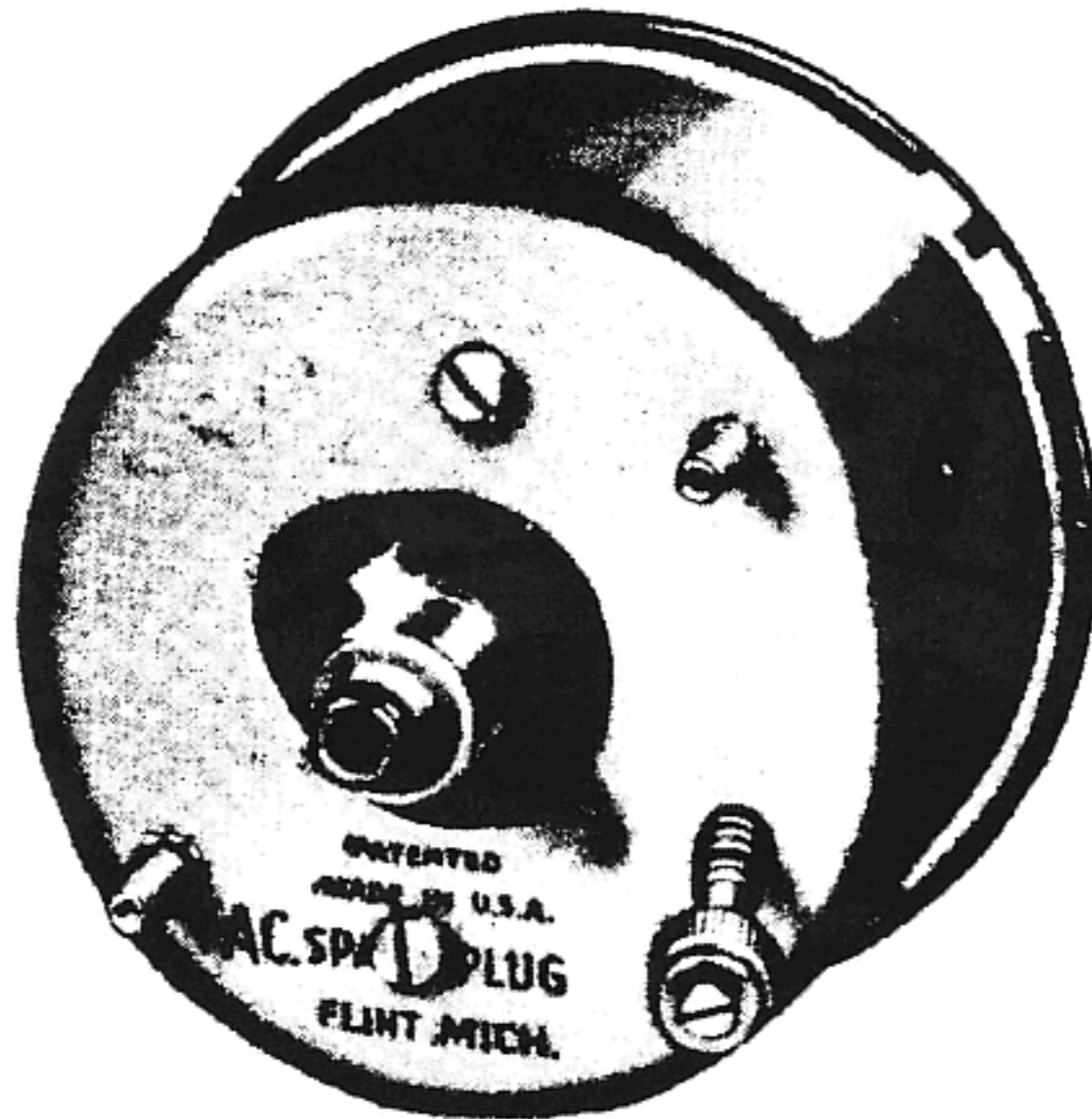

RA PD 318894

**Figure 9--Rear of AC Speedometer**

PART NUMBER

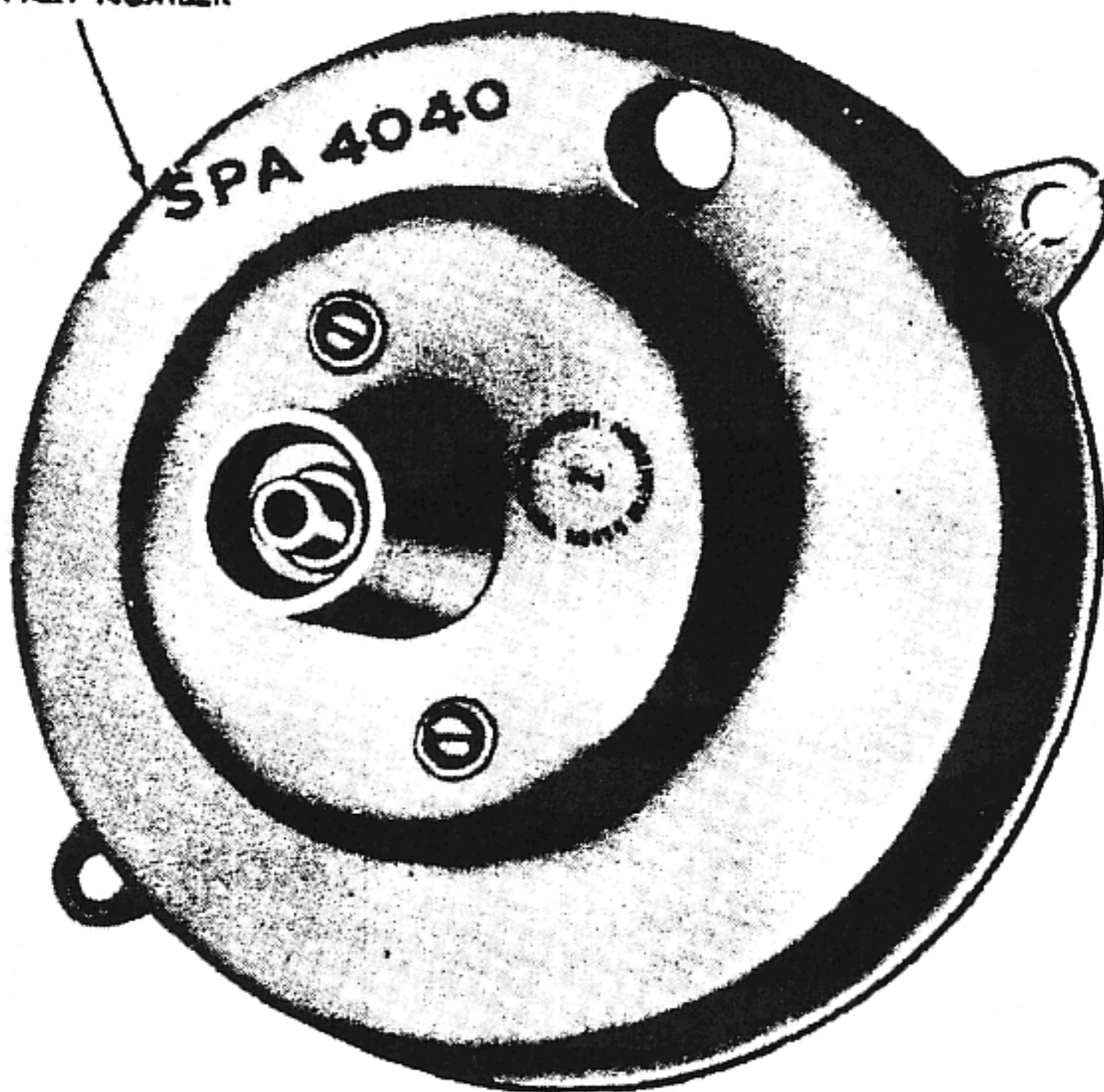

RA PD 318895

**Figure 10--Rear of Auto-Lite Speedometer**

## MAGNETIC-TYPE SPEEDOMETERS AND TACHOMETERS; DESCRIPTION, OPERATION, IDENTIFICATION, AND TESTING

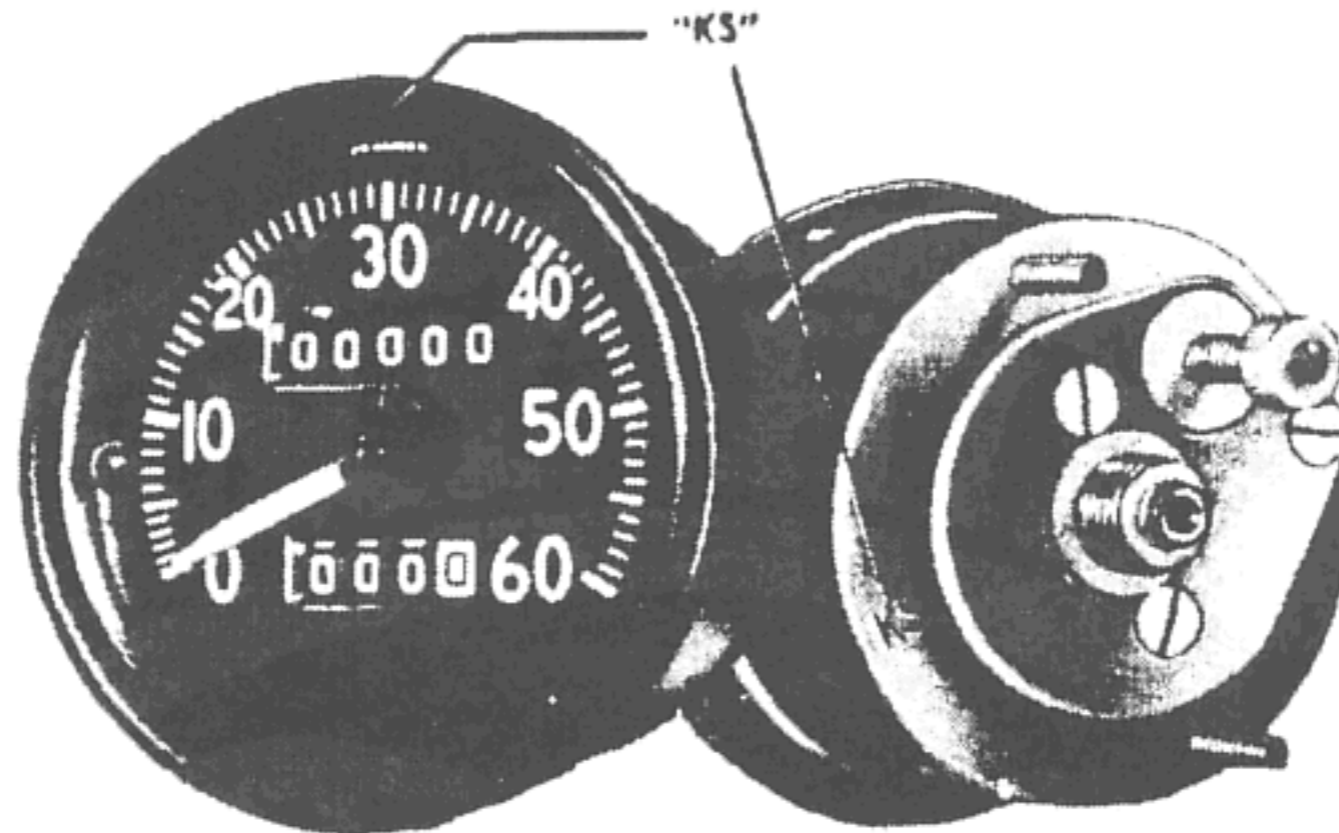

RA PD 318896

**Figure 11—Front and Rear of King-Seeley Speedometer**

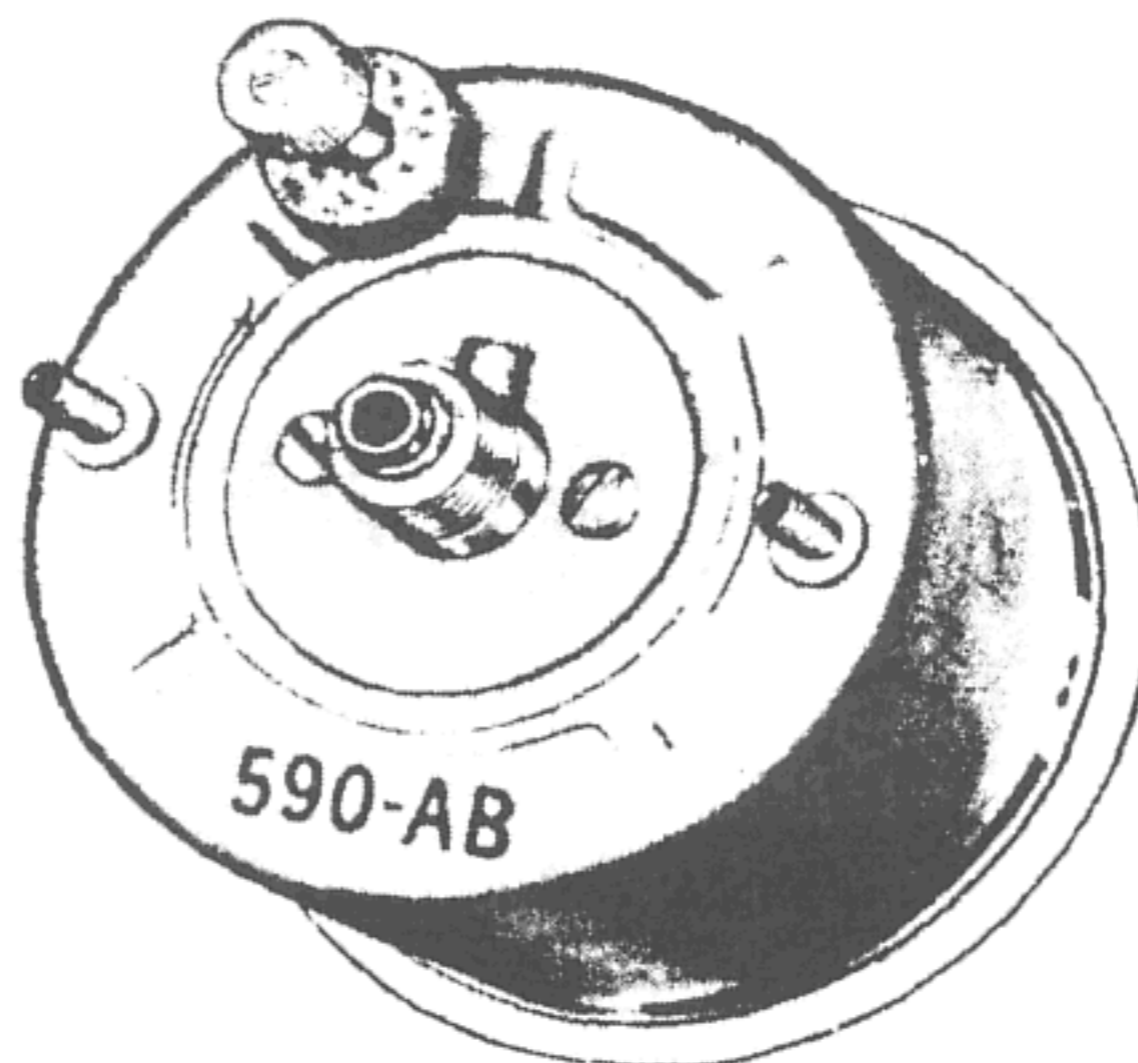

RA PD 318897

**Figure 12—Rear of Stewart-Warner Speedometer**

### 4. BENCH TEST PROCEDURE.

a. **General.** The following test procedure covers all makes of magnetic-type speedometers and tachometers in this manual. Instruments made by the different manufacturers are located in the manual as follows: (1) "AC"—chapter 3. (2) Auto-Lite (Motometer)—chapter 4. (3) King-Seeley—chapter 5. (4) Stewart-Warner—chapter 6. (5) Waltham—chapter 7. Refer to applicable chapter for detailed tests, which in some cases are special to each make of instrument.

b. **Test for Tight Mechanism.** First check to determine whether or not the speedometer or tachometer turns freely. This may be done

**ORDNANCE MAINTENANCE  
SPEEDOMETERS, TACHOMETERS, AND RECORDERS**

*http://jeepdraw.com  
FREE DOWNLOAD  
Thanks to G503.com  
Jon Rogers & Pete Silfven*

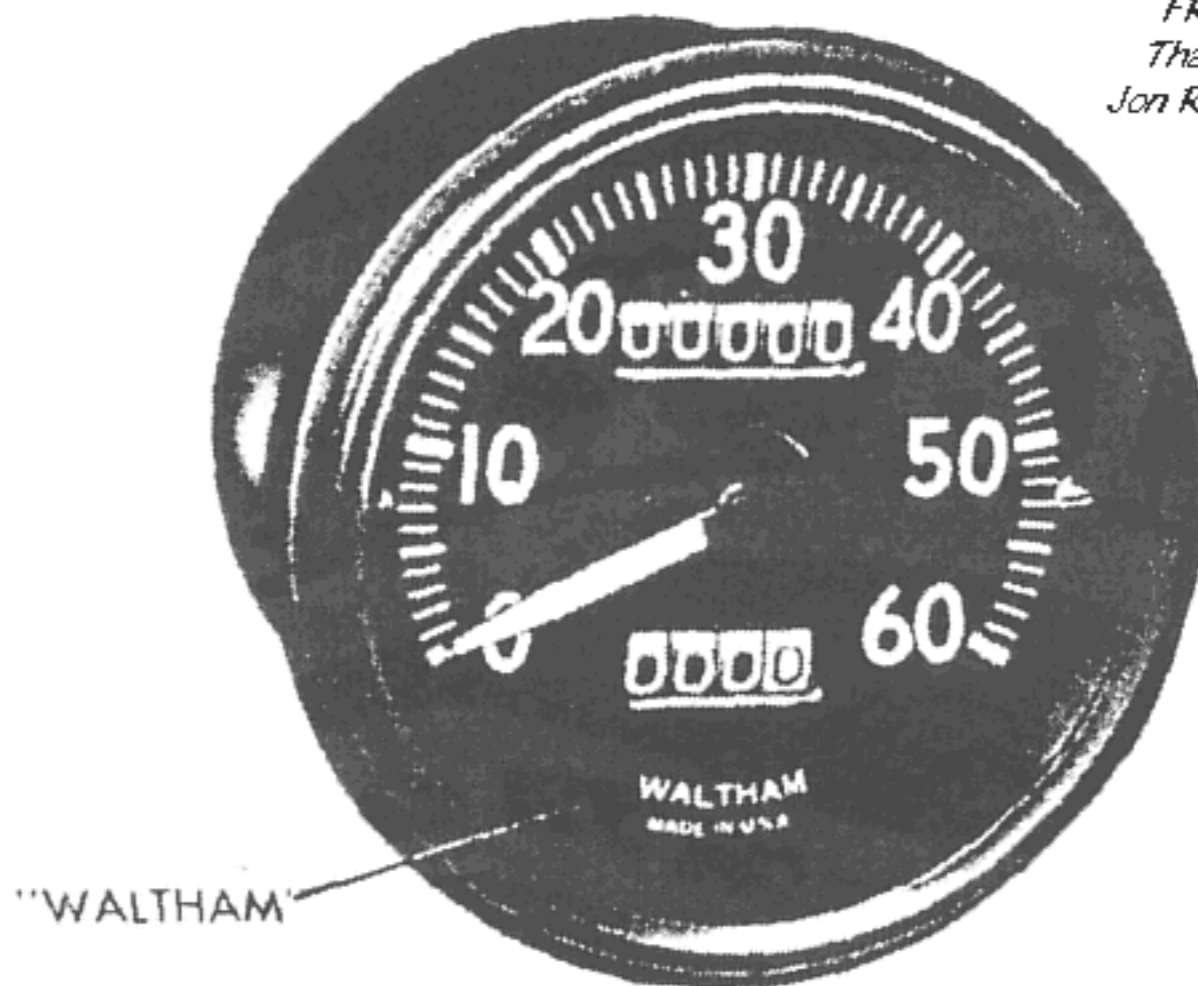

RA PD 318898

**Figure 13—Waltham Speedometer**

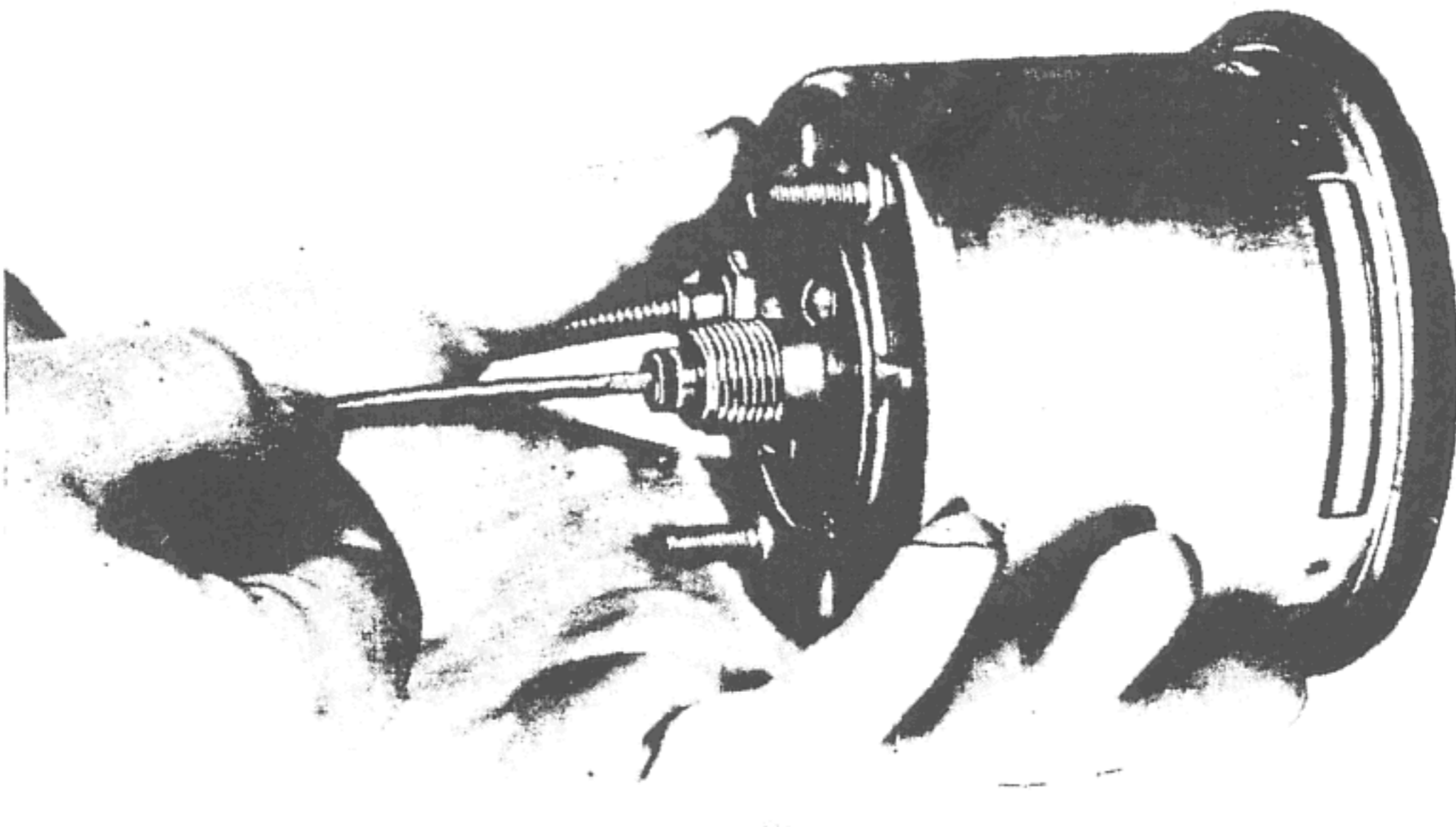

RA PD 318899

**Figure 14—Testing for Tight Mechanism**

by using a short piece of inner core (3 to 4 inches long) with proper tip to fit the drive position at the neck of the instrument being tested. Insert the short piece of core in instrument socket and turn slowly 15 to 20 turns (fig. 14). Tightness may be noticeable in one spot, or over a complete revolution. If tightness or binding is apparent, the instrument should be completely disassembled, and the defective parts repaired or replaced.

c. **Test Hair Spring and Magnet.** If the instrument mechanism turns freely, an initial fast spin of the short test cable should swing

## **MAGNET-TYPE SPEEDOMETERS AND TACHOMETERS; DESCRIPTION, OPERATION, IDENTIFICATION, AND TESTING**

the pointer over from zero to about half scale register. From half scale the pointer should quickly return to zero. This indicates reasonable hair spring and magnet performance.

**d. Test for Calibration.** Providing the instrument is not "bound up" (test b), place on the calibrating machine (T-170645) and run at various speeds. Note instrument readings obtained as compared with the master head. (When checking tachometers it is necessary to know ratio of speed indication to shaft speed. This ratio is sometimes stamped on the case.) (A speedometer or tachometer may be checked on the vehicle by using the special flexible shafts supplied with the calibrating machine.) The cause and remedies of any irregularities can be found by referring to subparagraph g following. Refer to chapter 13 for further instructions.

**e. Test Odometer.** While checking the unit on the calibrating machine, note if the odometer is functioning. If it is not, the unit must be disassembled and repaired.

**f.** If instrument passes tests b, c, d, and e above without showing defects, then it is in proper working order, and the trouble must be in flexible shaft, drive gears, or fittings on vehicle.

**g. Probable Causes and Remedies of Defective Instruments.** Following is a list of common troubles some of which may not apply to all makes of instruments. For complete information on each make instrument refer to applicable chapter.

### **(1) POINTER FLUCTUATES OR WAVERS.**

**(a) Broken, Worn, Dry, or Dirty Front or Rear Jewel.** Replace, clean, or lubricate jewels according to manufacturer's recommendations.

**(b) Excessive End Play in Magnet Shaft.** Reflare collar on end of magnet shaft.

**(c) Dirt, Grease, or Foreign Matter on Magnet and Speed Cup.** Clean speed cup and magnet with cloth. Care must be taken to prevent damage to the speed cup and hair spring.

**(d) Speed Cup Staff Rusted or Corroded at Jewels.** Clean ends of staff. If too badly rusted or corroded, discard.

**(e) Worn Main Frame Magnet Shaft Bearing.** Replace main frame or magnet assembly as required.

**(f) Rear Jewel Out of Line.** Line up rear jewel bracket with main frame. If bracket is bent, discard.

**(g) Bent Speed Cup Staff.** Discard and replace.

**(h) Field Plate Not Positioned Properly.** Relocate field plate. Clearance between speed cup and field plate must be uniform.

### **(2) INADEQUATE ZERO BANK (POINTER DOES NOT RETURN TO ZERO).**

**(a) Weak, Broken, or Improperly Adjusted Hair Spring.** Replace or adjust hair spring, or replace hair spring and speed cup assembly (as specified by manufacturer).



## ORDNANCE MAINTENANCE SPEEDOMETERS, TACHOMETERS, AND RECORDERS

(b) *Front Jewel Too Tight.* If there is insufficient play in speed cup staff, adjust upper jewel.

(c) *Dirt or Grease in Mechanism.* Disassemble and clean.

(d) *Pointer Improperly Set.* Remove pointer and reset at zero mark on face dial.

(e) *Broken or Distorted Hair Spring Regulator.* Replace regulator.

(3) **INCORRECT SPEED INDICATION.**

(a) *Dirty or Grease-filled Mechanism.* Disassemble and clean.

(b) *Out of Calibration.* Recalibrate.

(4) **INSTRUMENT SHOWS CORRECT SPEED INDICATION OVER APPROXIMATELY ONE-HALF THE DIAL, AND INCORRECT READING OVER BALANCE OF DIAL.**

(a) *Hair Spring Coils Touching.* True hair spring with tweezers.

(b) *Field Plate Eccentric with Speed Cup.* Loosen field plate and move toward high-registering part of dial, then tighten screws.

(c) *Speed Cup not in Static Balance.* Replace or balance speed cup.

(5) **EXCESSIVE NOISE.** Too much end play in magnet shaft, or worn gears, may cause noise in instrument. To correct, flare magnet shaft or replace gears as required.

(6) **INOPERATIVE ODOMETER.**

(a) *First Gear (on Magnet Shaft) Stripped.* Replace magnet and shaft.

(b) *Excessive End Play in Second Gear.* Adjust to proper end play.

(c) *Second and Third Gears Stripped or Worn.* Replace gears.

(d) *Odometer Bound Up.* Replace complete odometer assembly. Do not attempt to repair unless so specified in this manual.

(e) *Odometer Intermediate Gear Turning on Shaft (Stewart-Warner only).* Restake gear on shaft.

(7) **ODOMETER OPERATES BUT DOES NOT RECORD CORRECTLY.**

(a) *Wrong Second and Third Gears.* Replace with correct gears. (Gears used in speedometers reading in kilos are approximately  $\frac{1}{3}$  faster than gears used in speedometers reading in miles.) **NOTE:** *When odometers do not accurately record the distance traveled, it may be caused by the wrong speedometer drive and driven gears in the transmission of the vehicle, or by a change in the tire size on the vehicle. Such errors can be corrected by installing the proper ratio drive joint (or adapter) at the flexible shaft connection on the transmission*

*http://jeepdraw.com*  
 FREE DOWNLOAD  
 Thanks to G503.com  
 Jon Rogers & Pete Silfven

## CHAPTER 3

# AC DIVISION OF GENERAL MOTORS SPEEDOMETERS AND TACHOMETERS

### 5. DESCRIPTION.

a. The following disassembled view of an "AC" speedometer (fig. 15) is typical of these units. Minor variations in details will be encountered, such as: two types of jewel brackets which are not interchangeable, except when a matching speed cup is also used; or two types of magnet and first gear drive which are not interchangeable, except when a matching main frame is also used. Further, some speedometers are supplied without reset-type odometers, known as triplex types. Some units are equipped with solid reset shafts, while others use flexible reset shafts. "AC" speedometers and tachometers are furnished for two styles of cable drive. One type must be driven with a cable tip having a female square, the other having a male square. The female square drive is used with main frames having casing connector threads  $\frac{7}{8}$  in.—18. The male square drive is used with main frames having casing connector threads  $\frac{5}{8}$  in.—18. For complete description, operation, and test procedure, refer to paragraphs 2 and 4.

### 6. DISASSEMBLY.

a. **Remove Bezel.** Remove bezel by carefully cutting with side cutters so case and gaskets will not be cut, and glass will not be broken. Lift the glass, gaskets, and glass container from the case. On front reset speedometers, first pull off rubber tip and then remove spring and washer.

b. **Remove Case.** Remove two screws and lock washers from back of case, and lift out frame and mechanism assembly. Dustproof sealing sometimes causes frame to stick to case. **NOTE:** *If instrument has reset odometer, first remove the screw and knob from reset shaft.*

c. **Remove Pointer and Dial.** Grasp the pointer hub between the thumb and forefinger, and twist gently in a direction reverse from normal pointer travel. Lift the pointer off the shaft while performing the twisting operation. Use a small screwdriver to remove the two dial screws, and lift dial off frame. **NOTE:** *It is important to use a screwdriver that fits the dial screw slots because a poor-fitting screwdriver will often slip and mar the dial or break off luminous paint.*

d. **Remove Front Jewel and Bracket.** Remove two bracket retaining screws and lift off jewel and bracket. **NOTE:** *Look for and salvage the speed cup staff thrust washer. This washer may stick to jewel in bracket, or on step of speed cup staff. On front reset speedometers, the reset shaft should be removed from the jewel bracket.*

e. **Remove Odometer—Total and Trip Not of the Quick-reset Type.** Remove the retainer from the left end of the odometer shaft. To do this, raise clip until enlarged portion of clip slot is over the odometer shaft, then push the shaft into the frame and lift the clip upward. Push the odometer shaft out with short piece of wire or rod.

**ORDNANCE MAINTENANCE  
SPEEDOMETERS, TACHOMETERS, AND RECORDERS**

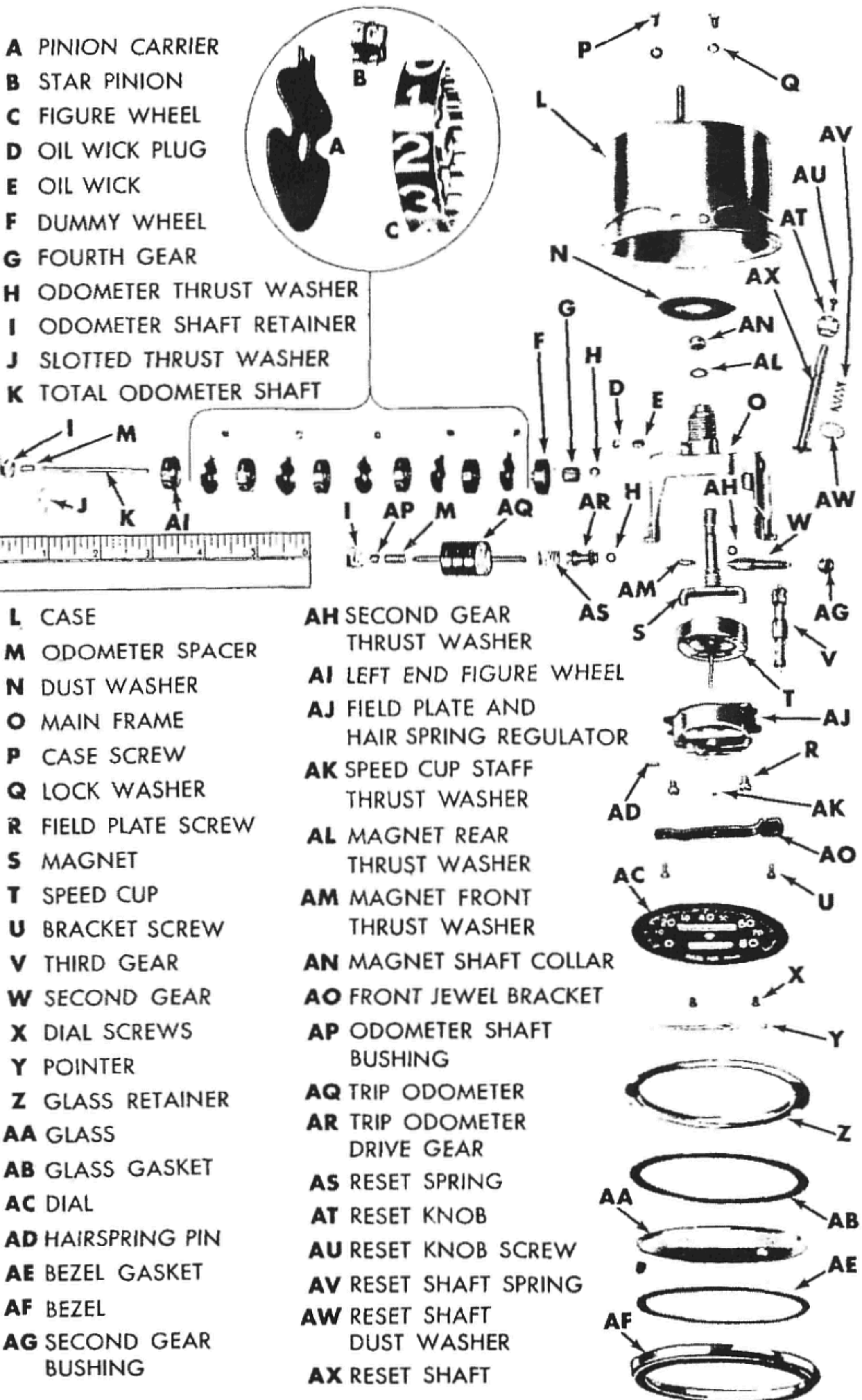

RA PD 318900

**Figure 15—AC Speedometer Disassembled**

AC DIVISION OF GENERAL MOTORS  
SPEEDOMETERS AND TACHOMETERS

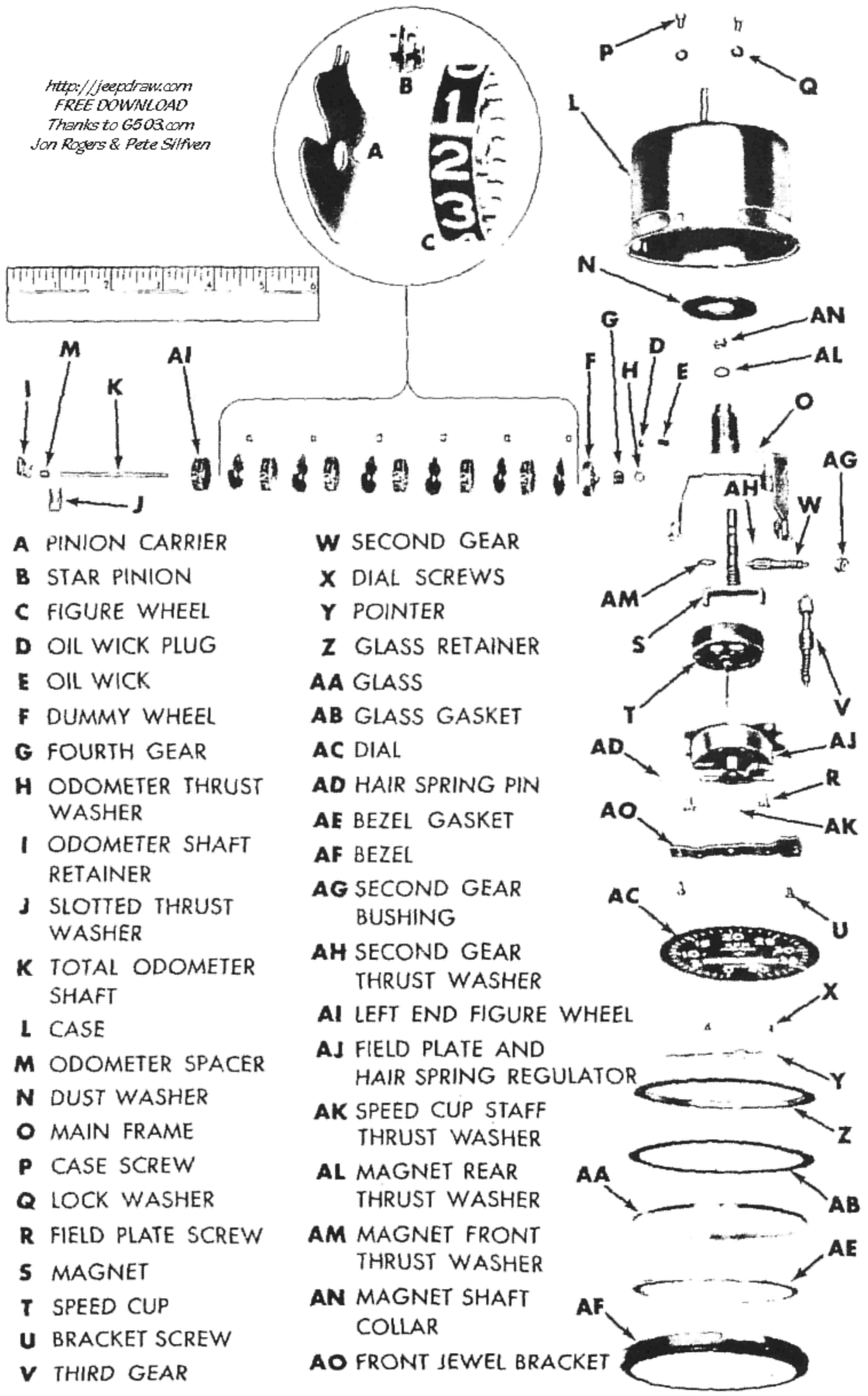

RA PD 318901

Figure 16—AC Tachometer Disassembled

**ORDNANCE MAINTENANCE  
SPEEDOMETERS, TACHOMETERS, AND RECORDERS**

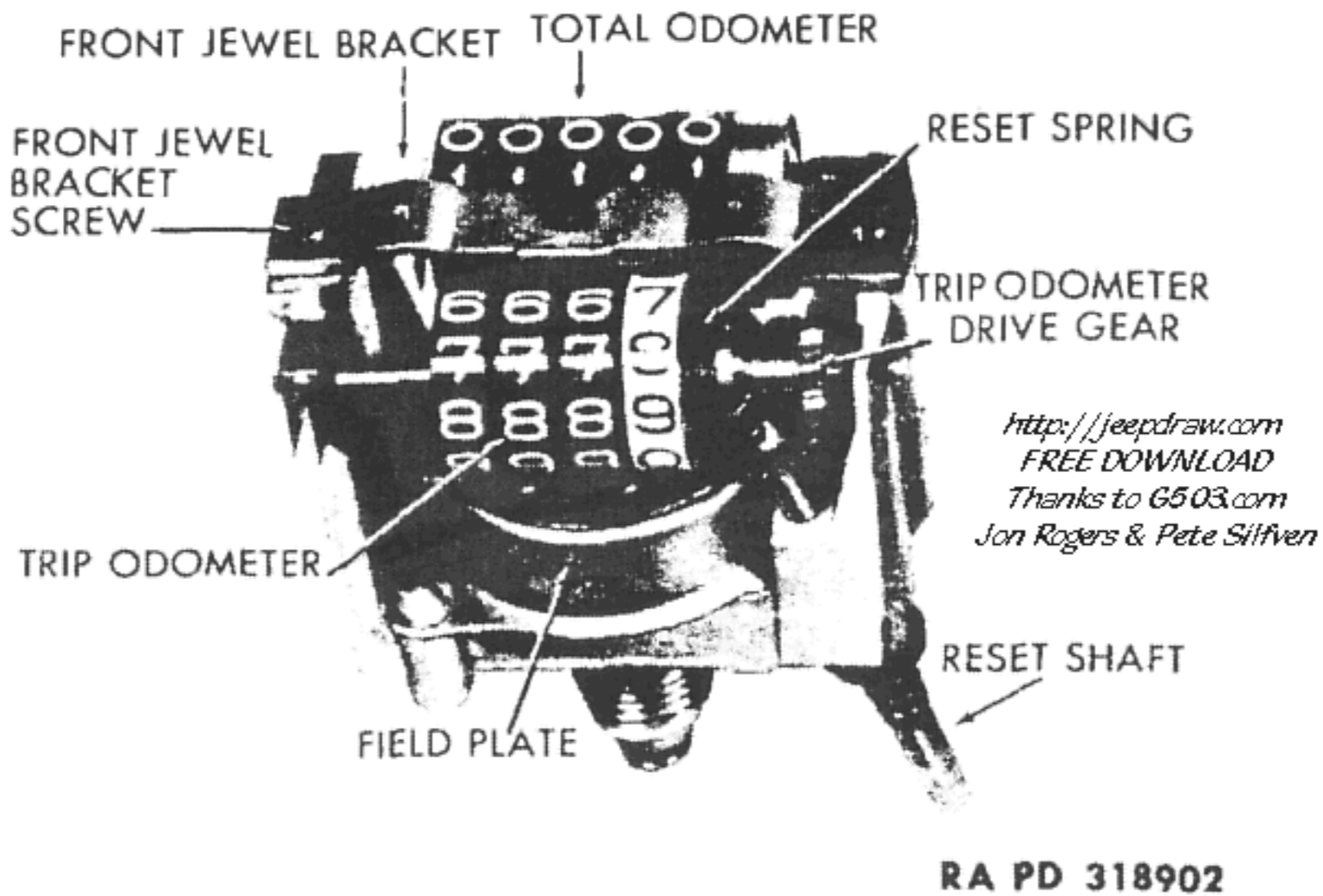

**Figure 17—Speedometer Mechanism (Dial Removed)**

Centralize the short rod in the frame and lift the odometer out as a unit.

f. **Remove Odometer—Quick-reset Trip Type** (fig. 18). Remove the retainer from the left end of the trip odometer shaft, tip the speedometer slightly to the left, and permit the shaft bushing and

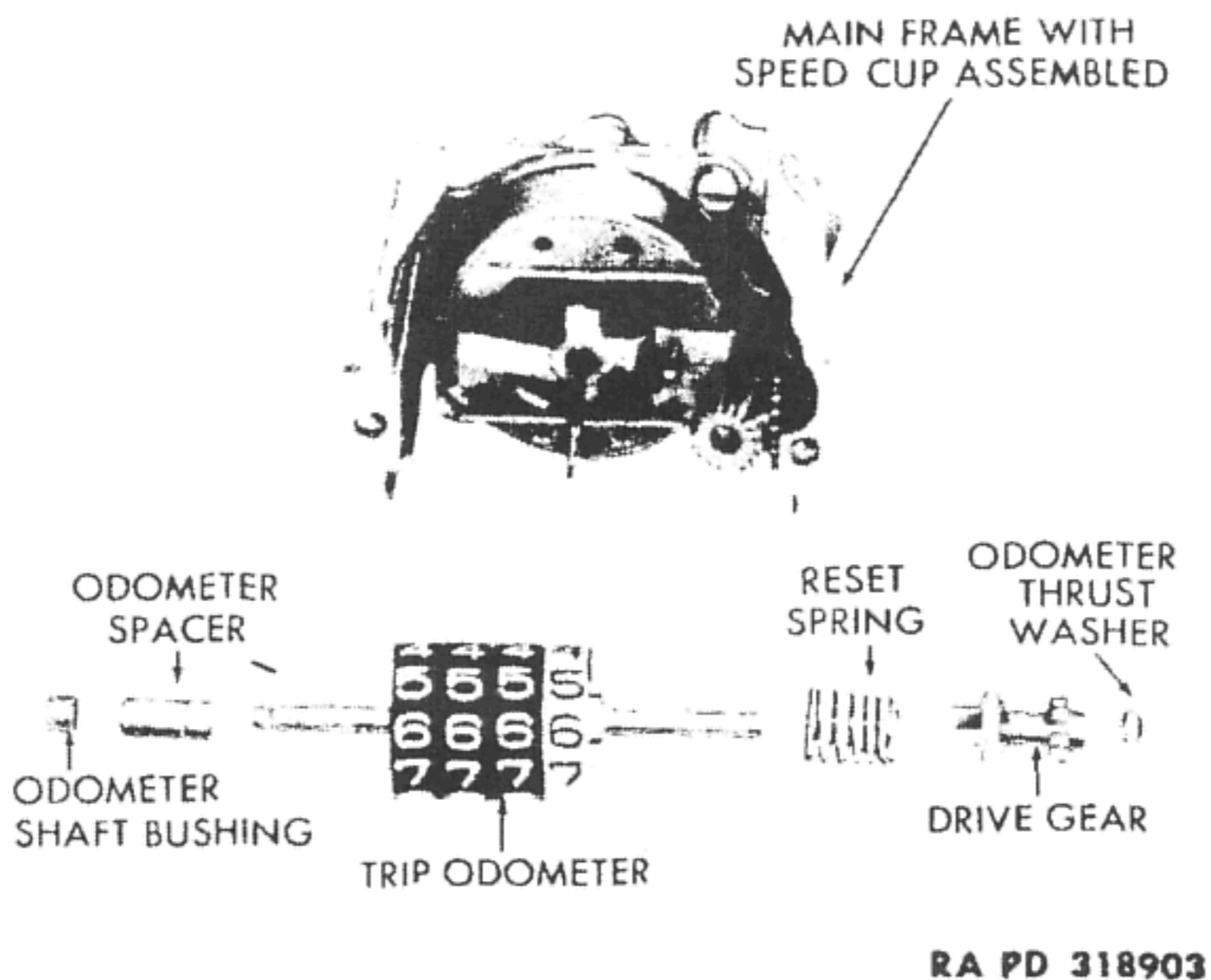

**Figure 18—Quick Reset Trip Odometer Removed from Frame**

spacer to slide off the shaft. Lift out the odometer by first moving it to the left, and then remove thrust washer, trip drive gear, and drive gear spring. **NOTE:** Do not remove the retainer which is clipped to the shaft at the left of quick-reset figure wheels. Service the quick-reset odometer and shaft only as an assembly.

## AC DIVISION OF GENERAL MOTORS SPEEDOMETERS AND TACHOMETERS

**g. Remove Reset Shaft.** Remove the solid reset shaft and gear assembly from the main frame by lifting the lower coil of the reset shaft spring from the groove around the shaft. Remove reset knob if used. Lift reset shaft out of frame. Flexible reset shafts are serviced as part of the main frame.

**h. Remove Third Gear.** Lift out of frame.

**i. Remove Field Plate and Speed Cup.** With a small pair of pliers, remove tapered pin securing end of hair spring in regulator

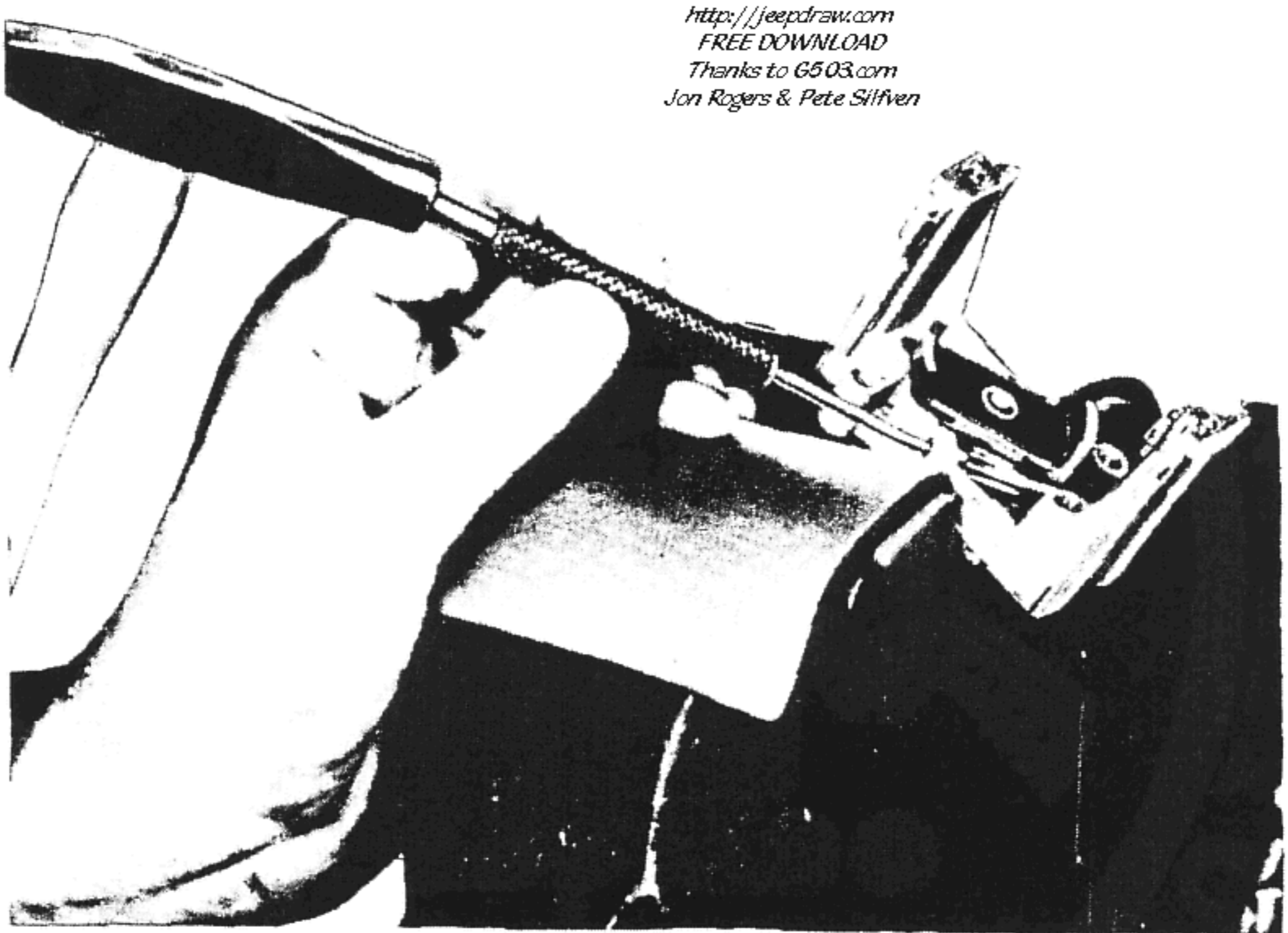

*http://jeepdraw.com  
FREE DOWNLOAD  
Thanks to G503.com  
Jon Rogers & Pete Silfven*

RA PD 318904

**Figure 19—Removing Second Gear from Frame**

arm of field plate. Push hair spring end out of regulator arm hole. Remove two screws holding field plate in position. Lift the two parts out successively, first the field plate, making sure the hair spring is not caught, then the speed cup. **NOTE:** *AC speed cups are serviced as an assembly of the cup, staff and hair spring. Do not disassemble.*

**j. Remove Second Gear (fig. 19).** Use punch to drive out the second gear, bushing, and thrust washer. Drive from the end opposite to the inserted bushing. Remove thrust washer which usually sticks to side of main frame. **NOTE:** *Use care in driving out the second gear to avoid marring bearing hole in frame.*

**k. Remove Oil Wick.** Remove sealing plug and oil wick from neck of speedometer frame. Small screwdriver or scratch awl may be used.

**ORDNANCE MAINTENANCE  
SPEEDOMETERS, TACHOMETERS, AND RECORDERS**

**1. Remove Magnet and First Gear (fig. 20).**

(1) FROM "L" SPEEDOMETER. Back off screw in tool (T-170654). Then assemble tool on threaded neck of main frame. Turn screw down until it has forced magnet shaft out of collar. Remove tool, collar, collar thrust washer, magnet and shaft, and thrust washer.

(2) FROM "N" SERIES SPEEDOMETERS. Back off screw in tool (T-170654). Then assemble tool on threaded neck of main frame. Turn small screw down until it has forced magnet shaft out of the collar. Remove tool, collar, and thrust washer. Push magnet and shaft back to its original position. Continue to hold magnet and shaft in its original position and smooth down the ragged flare edge with a

*http://jeepdraw.com  
FREE DOWNLOAD  
Thanks to G503.com  
Jon Rogers & Pete Silfven*

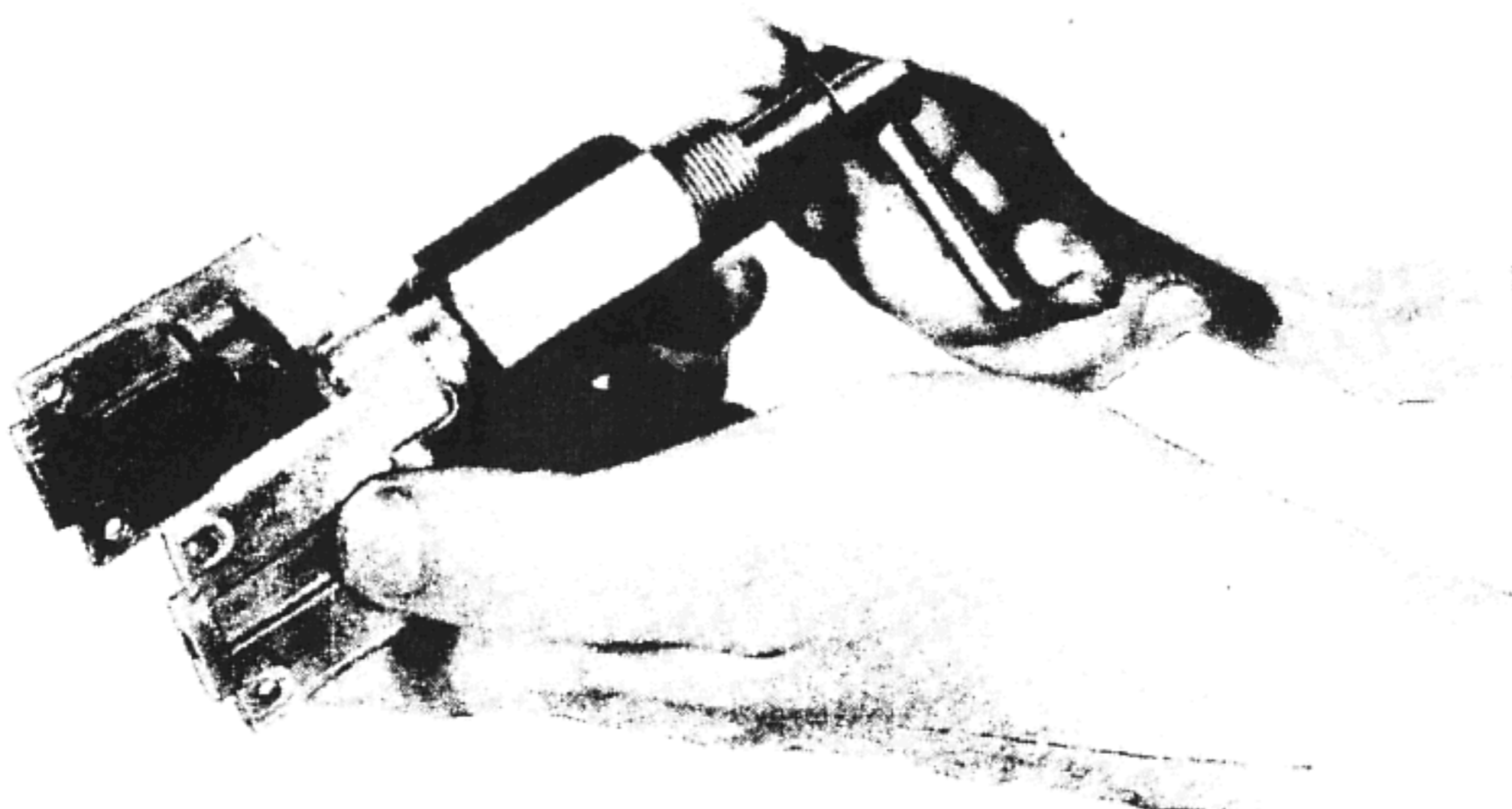

RA PD 318905

**Figure 20—Removing Magnet Shaft Collar, Using Dismantling Wrench (T-170654)**

safety-edge file. CAUTION: Do not force magnet shaft through frame bearing. Flare must be filed until magnet shaft will drop out of frame, otherwise frame bearing will be scratched beyond repair. Do not touch end of frame with file as this is a thrust bearing surface.

**m. Remove Intermediate Gear.** (Perform this operation only if gear is stripped or otherwise damaged.) Remove intermediate gear from main frame by drilling to remove riveted portion of stud. Drive stud out of frame with small punch.

**7. CLEANING, INSPECTION, AND REPAIR OF PARTS.**

**a. Cleaning of Unit Parts.** Clean all internal parts in dry-cleaning solvent. In many cases only a complete cleaning will show up the parts which have been causing trouble. The cleaned parts should be

<http://jeepdraw.com>  
FREE DOWNLOAD  
Thanks to G503.com  
Jon Rogers & Pete Silfven

## AC DIVISION OF GENERAL MOTORS SPEEDOMETERS AND TACHOMETERS

dried with compressed air. Use care in drying the speed cup so the hair spring is not damaged. Make sure speed cup bearing in magnet and magnet surfaces under compensator are fully dry, because wet cleaning fluid at these points will cause corrosion due to thinned out watch oil.

**b. Inspection of Unit Parts.** Inspection of individual speedometer parts is a matter of close observation, frequently under a magnifying glass, and a sense of feel for rough bearing points. Following are suggestions for inspection of various parts:

(1) **PINION AND CARRIER.** Place pinion in slot of carrier and revolve pinion. Discard pinion if slightest binding is apparent. Examine gear teeth of pinion and discard pinion if teeth are marred. Replace pinion carrier if burs or other sources of binding are apparent from touch or sight.

(2) **MAGNET SHAFT COLLAR.** Replace if damaged.

(3) **SPEED CUP.** Slight roughness at bearing points of the spindle can sometimes be cleaned with crocus cloth. Speed cups must be in static balance and concentric to operate properly. Clearance between magnet and speed cup, and speed cup and field plate is close. Accordingly, it is recommended that the speed cup be replaced if at all questionable. Adequate hair spring action can only be obtained when the spring is horizontal and each coil is evenly spaced when checked in the wound position. To obtain this condition the hair spring must be trued with tweezers to give clearance between coils when spring is in wound position.

(4) **MAIN FRAME.** Magnet shaft bearing surface must be mirror-bright, and free from scratches. Install magnet shaft into main frame, and replace frame if more than 0.003-inch to 0.004-inch side play is apparent.

(5) **ODOMETER SHAFT.** Roll on surface plate to insure being perfectly straight. Shaft should check 0.125-inch diameter  $+0.000$  inch to 0.0005 inch. Discard if worn or bent.

(6) **ALL GEARS.** Replace gears if burred, nicked, or worn at teeth.

(7) **FIGURE WHEELS.** Replace if numerals are marred or inner ring teeth are damaged.

(8) **MAGNET AND SHAFT.** Replace magnet if it will not take a magnetic charge. Replace "N" series magnets if the flaring end is too short to form an adequate flare over the retaining collar. Replace magnet if the speed cup staff bearing is rough, or if the bearing causes the speedcup to drag. **NOTE:** See calibration (par. 9) for more information.

(9) **DIAL.** Visually inspect for general appearance, flatness, paint mars, chipped luminous numerals and graduations. Depending on available facilities, a damaged dial may be repaired or replaced.



**ORDNANCE MAINTENANCE  
SPEEDOMETERS, TACHOMETERS, AND RECORDERS**

**8. ASSEMBLY.**

a. **Install Magnet and Shaft.** These assembly instructions are based on the assumption that the speedometer main frame is positioned in the same manner as when installed in the vehicle. Place front thrust washer on magnet shaft, lubricate first gear teeth with No. 00 Grease, O.D.; oil magnet shaft bearing lightly with watch and clock oil; insert first gear into position in frame and place thrust washer around rear end.

*http://jeepdraw.com  
FREE DOWNLOAD  
Thanks to G503.com  
Jon Rogers & Pete Silfven*

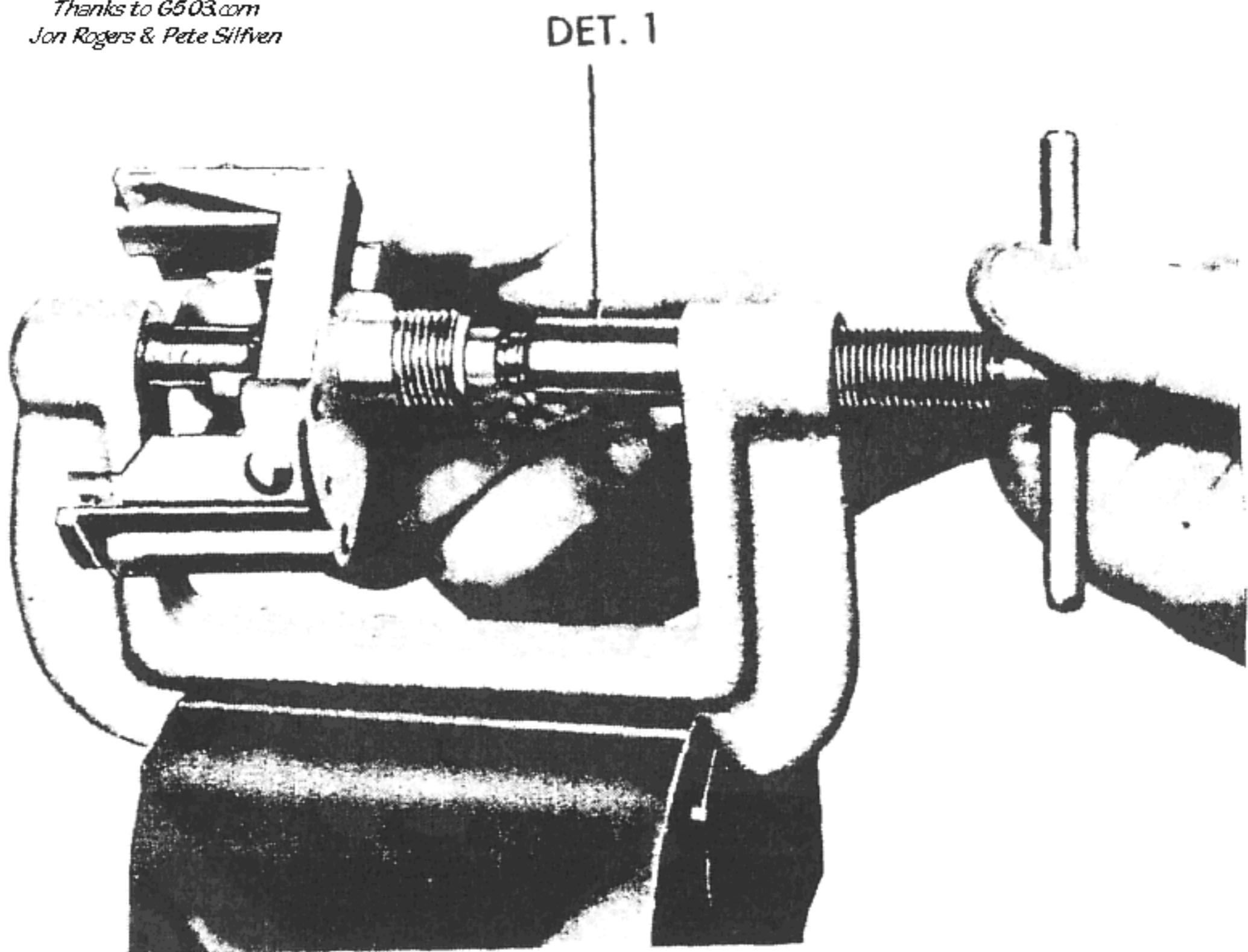

RA PD 318906

**Figure 21—Pressing Collar on Magnet Shaft, Using Fixture  
(T-170666 with Det 1)**

(1) "L" SERIES SPEEDOMETER. Place retaining collar over square end of magnet shaft with small shoulder to rear, and press into place with clamp (T-170666 with Det 1).

(2) "N" SERIES SPEEDOMETER. Seat the retaining collar with groove to rear on lower end of magnet shaft with tool (T-170666 with Det 1). Retaining collar is seated when first gear end play is barely perceptible. Stake the protruding magnet shaft stock over the collar with tool (T-170666 with Det 6).

(3) ALLOWABLE END PLAY FOR BOTH "L" & "N" SERIES. After the foregoing operations, it is important that magnet shaft turn

**AC DIVISION OF GENERAL MOTORS  
SPEEDOMETERS AND TACHOMETERS**

*http://jeepdraw.com  
FREE DOWNLOAD  
Thanks to G503.com  
Jon Rogers & Pete Silfven*

freely; in addition, its end play must be barely perceptible (approx 0.001 inch to 0.003 inch) when moved with the fingers. If magnet shaft does not turn freely, this can usually be corrected on the model "L" by tapping the squared end of shaft lightly with a small rawhide hammer. Correction on model "N" requires use of tool (T-170654) (fig. 20).

b. **Install Oil Wick.** Saturate oil wick in watch and clock oil, and insert wick inside of speedometer neck. Enlarge sealing plug with

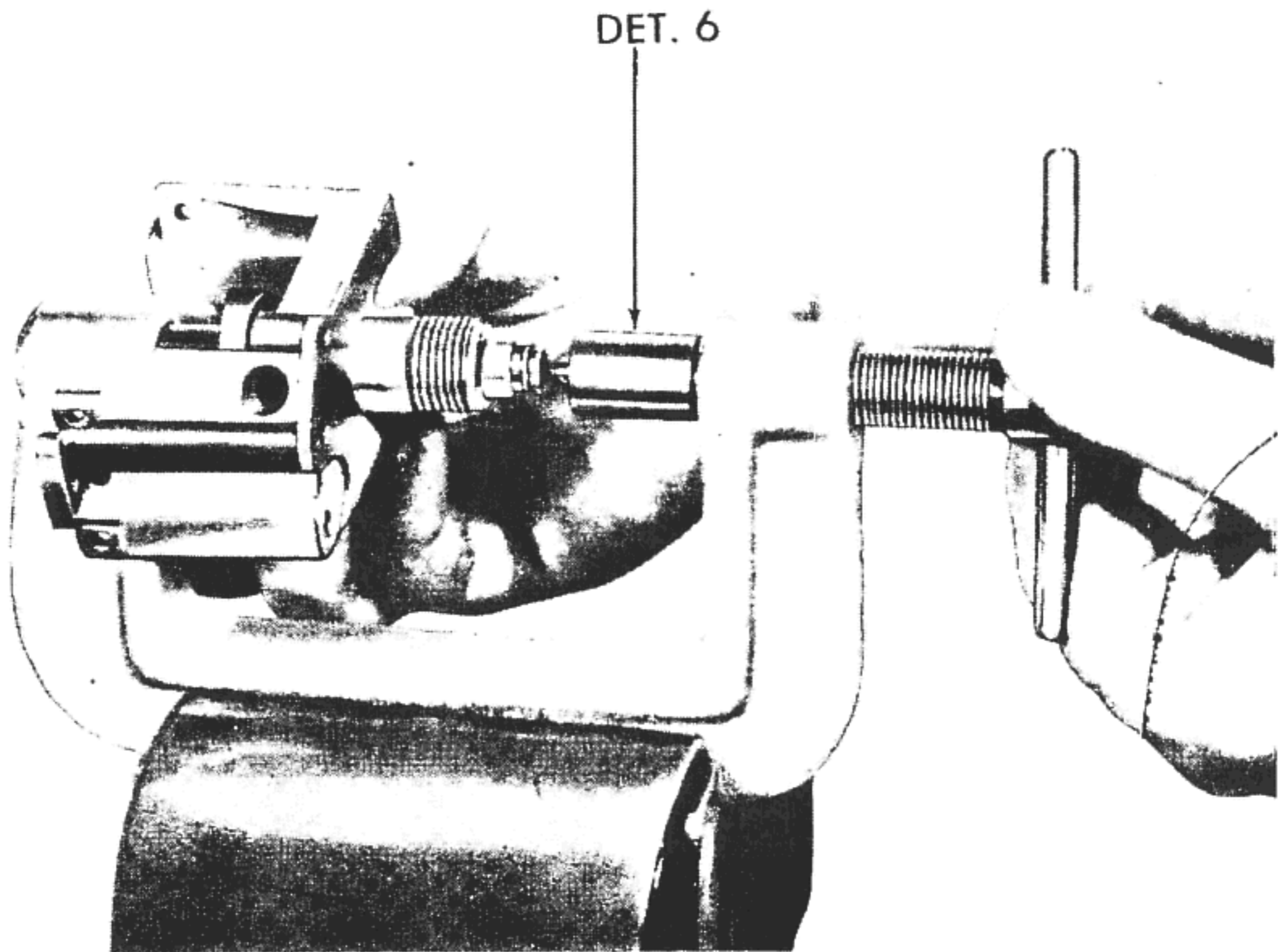

RA PD 318907

**Figure 22—Flaring Magnet Shaft, Using Fixture  
(T-170666 with Det 6)**

small screwdriver blade and position in hole on top of oil wick and tap in place with small mallet or screwdriver handle.

c. **Install Second Gear.** Lubricate teeth on second gear lightly with No. 00 Grease O.D. Place thrust washer on tenon at gear end of second gear. Bushing has small taper relief on end which enters frame. Tap bushing into main frame with small rawhide mallet. Adjust bushing to give second gear 0.010-inch to 0.015-inch end play. Tap bushing squarely so that no burs will result.

d. **Install Speed Cup and Field Plate.** Place one drop of watch and clock oil in jewel hole on upper end of first gear and magnet. (Oil may be applied with clean, small nail or wire dipped in oil supply.)

## ORDNANCE MAINTENANCE SPEEDOMETERS, TACHOMETERS, AND RECORDERS

Lubricate both ends of speed cup spindle sparingly with watch and clock oil, and place lower end of staff in magnet jewel. Hold field plate over speed cup in frame, with relief for third gear over third gear bearing in frame, before dropping down in position over speed cup spindle. Stop on speed cup must rest above stop at left of field plate. Retain field plate loosely in position with two screws. Insert hair spring up to first bend into regulator arm hole, and retain in position with taper pin.

e. **Install Rear Reset Shaft** (applies only to units with trip odometer and solid rear reset shaft). Slide reset shaft into hole at right, lower end of frame. Secure in place from back of frame with reset shaft spring, snapping lower coil of spring into groove in shaft. **NOTE:** *Flexible reset shafts are serviced as an integral part of the main frame. See note at end of following subparagraph g for front reset shaft.*

f. **Install Third Gear.** Lubricate teeth on third gear with No. 00 Grease, O.D. and install in main frame. Helical gear meshes with worm of second gear.

g. **Install Front Jewel and Bracket Assembly.** Place small composition thrust washer over upper end of speed cup spindle. Install front jewel and bracket assembly on main frame, and retain lightly with two screws. Make sure that speed cup spindle and third gear upper bearings are assembled properly through jewel and bracket. Before finally tightening jewel bracket screws, make sure there is sufficient end play in the spindle to prevent jewel damage or broken spindle. With the first gear pushed forward, adjust jewel in bracket to give speed cup spindle 0.003-inch to 0.006-inch end play. Use tool (846854) for "L" and (846862) for "N" series speedometer. **NOTE:** *Front reset shafts must be installed in jewel bracket before bracket is attached to frame.*

h. **Final Positioning of Field Plate.** Turn frame assembly upside-down, and adjust field plate so that it is concentric with speed cup. Rotate speed cup by rolling spindle between fingers to check uniformity of gap between speed cup and field plate while frame is inverted. When field plate is correctly positioned, tighten screws to retain and recheck concentricity.

i. **Assemble and Install Trip Odometer** (applies only to quick-reset odometer). Place drive sleeve spring and drive sleeve over the right-hand end of trip odometer shaft. Install this assembly in the main frame. (Slots in the pinion carriers must be assembled over the retainer on field plate.) First insert the left end of the shaft from inside the frame. Move into position by sliding shaft through thrust washer at right end (while washer is held in position with tweezers). Install long odometer spacer and bushing over the left end of trip odometer shaft. Secure shaft in place with retainer. Insert one slotted spacer on odometer shaft between frame and inside legs of shaft retainer.

**AC DIVISION OF GENERAL MOTORS  
SPEEDOMETERS AND TACHOMETERS**

*http://jeepdraw.com  
FREE DOWNLOAD  
Thanks to G503.com  
Jon Rogers & Pete Silfven*

**j. Assemble Total Odometer.** Insert grooved end of odometer shaft through hole from right side of frame. Assemble one thrust washer, fourth worm, and dummy wheel on odometer shaft. Place a small amount of No. 00 Grease, O.D., in the top groove of the pinion carrier. Assemble the star pinion in the top groove of the pinion carrier with the six even teeth to the left. Assemble pinion carrier on the odometer shaft with slot over retainer on field plate. Make sure that one of the short (or half) teeth on the right side of the star pinion is assembled toward the outside diameter of the figure wheel, and that it is not engaged with the two gear teeth on the left side of the figure wheel. If this is assembled incorrectly, odometer will lock. Assemble a figure wheel, then a star pinion and carrier on the odometer shaft, continuing assembly in this manner until all figure wheels, pinion carriers, and star pinions are assembled. Next assemble odometer spacer on shaft and press shaft on through left side of frame, and secure in position with odometer shaft retainer. If other than a zero setting is desired, it should be done at this point. Disengage transfer pinion from 20-tooth side of wheel to be moved. When desired figure is up, re-engage with pinion. Check to make sure wheel figures line up and are not  $\frac{1}{2}$  figure off. If wheel is  $\frac{1}{2}$  figure off, disengage from pinion again and move wheel one tooth to bring in line and re-engage. Adjust each succeeding wheel to be set in the same way. Do not disturb the star pinion settings. The dial may be temporarily positioned to check alinement of figure wheels. Check end play of odometer, and insert split space washers to gain end play of 0.009 inch to 0.018 inch.

**k. Appearance.** Wipe excess lubricant and finger-prints off figure wheels with lintless cloth or soft chamois.

**l. Install Dial and Pointer.** Install dial on jewel bracket and retain with two screws. Place the pointer on the spindle so it points to about 30 miles per hour, and twist gently back to zero against speed cup stop while pressing lightly down. Tap pointer very lightly with small wooden-handled screwdriver to secure in position.

**m. Calibration.** The speedometer or tachometer should be calibrated at this stage of the assembly procedure (par. 9).

**n. Install Case, Bezel and Glass.** Install dust washer around neck of frame, and reset shaft if used. Drop case over neck of frame and retain with two screws and lock washers. Install into new bezel the outer gasket, glass, inner gasket retainer, and gasket. Invert the case in the bezel assembly, and secure bezel with crimping tool (T-178730) (figs. 74 and 75).

**o. Moisture- and Dustproof the Unit.** Brush sealing or plugging cement on all joining surfaces, and allow 15 to 20 minutes for drying. Butyle methacrylate can be thinned with toluol or equivalent.

## **9. CALIBRATION.**

**a. General.** The calibration of a speedometer or tachometer is the operation of electrically balancing the magnet with the hair spring

**ORDNANCE MAINTENANCE  
SPEEDOMETERS, TACHOMETERS, AND RECORDERS**

so that the unit checks at least three points of its scale with a master head. In the following instructions, it is stated that the magnet should first be overcharged by at least 50 percent, and then demagnetized to a state of correct balance with the hair spring. It is very important that this initial overcharge be given, otherwise the unit will gradually read lower. *NOTE: For example—if a pail is filled with water to the rim, some water will be splashed out as it is carried. However, if before carrying the pail of water, a little is intentionally spilled out, then the remainder can be carried safely for a long distance. In much the same way, reduction from maximum magnet strength has the*

*http://jeepdraw.com  
FREE DOWNLOAD  
Thanks to G503.com  
Jon Rogers & Pete Silfven*

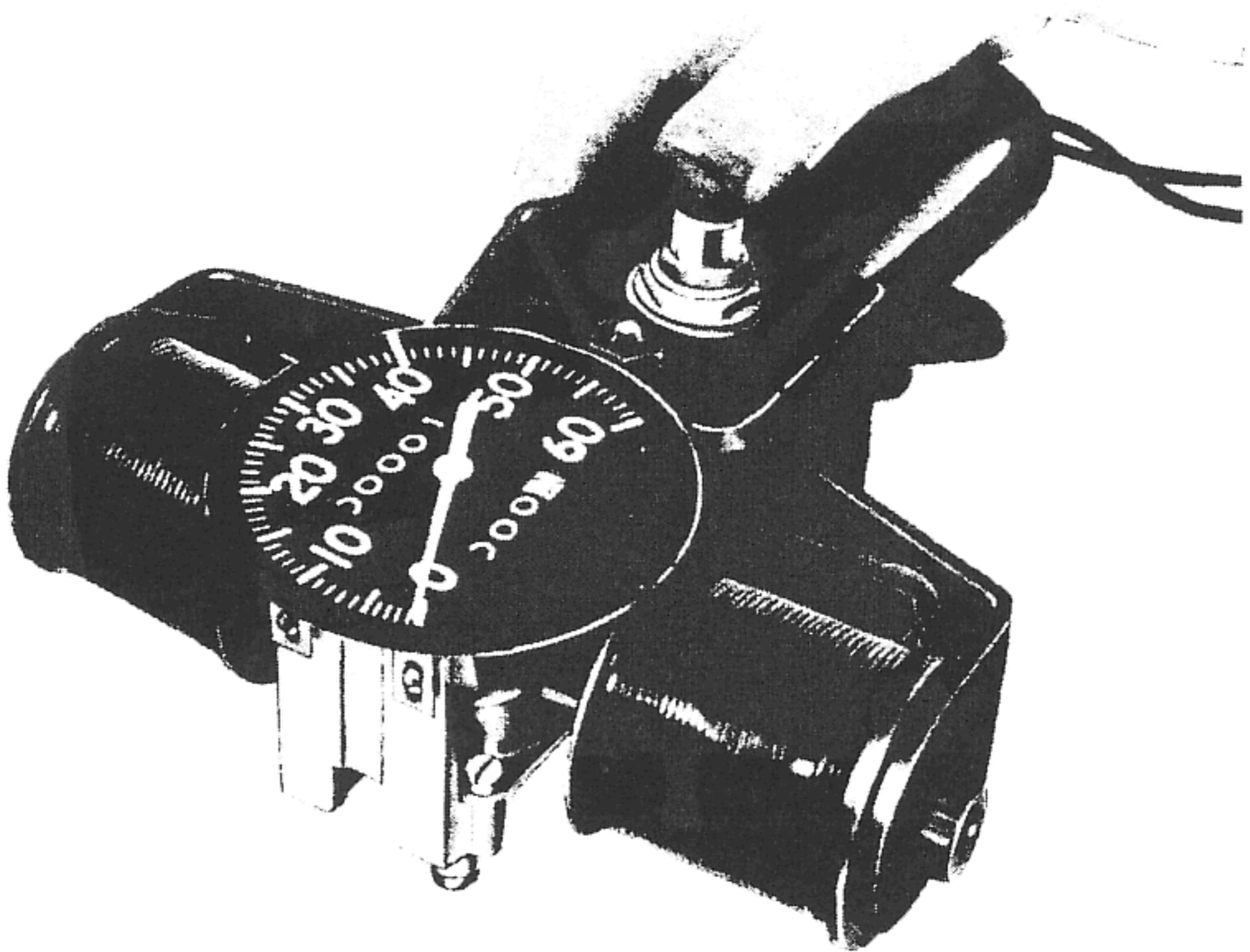

RA PD 318908

**Figure 23—Charging AC Speedometer or Tachometer Magnet,  
Using Magnetizer (846294)**

*effect of “setting” the magnet permanently at the desired strength. Some manufacturers accomplish a similar result by a three- to six-month aging process.*

**b. Charging the Magnet.** Connect the magnetizer (T-189785) to a 12-volt direct current source, preferably two 12-volt fully charged batteries in series. Clamp the magnetizer poles over the speedometer field plate. Turn the magnet by hand until it is at right angles to the magnetizer poles. Press the magnetizer button firmly for 2 or 3 seconds.

**AC DIVISION OF GENERAL MOTORS  
SPEEDOMETERS AND TACHOMETERS**

c. **Check Against Master Head.** Check the charged unit on calibrating machine with master head reading 10 miles per hour, and adjust hair spring regulator arm on field plate so that unit being tested reads 18 to 20 miles per hour. Refer to chapter 13 for further instructions.

d. **Check Magnet.** Run the master head up to 30 miles per hour and the unit being checked should read not less than 45 miles per hour. If this minimum reading cannot be obtained, it is usually caused by the magnet not being fully charged. This can be caused by the electrical equipment not functioning properly, or the inability of the magnet to retain a charge. Check that proper speed cup assembly is used as too strong a hair spring will show low, and too weak a hair spring a high speed reading. Test battery for specific gravity and individual cell voltage. If 12 volts were used the first time, try 24 volts. If magnet cannot be charged to show minimum of 50 percent overcharge, the magnet and first gear assembly must be removed from the speedometer and replaced with a new one from stock.

e. **Demagnetize.** When the minimum of 45 miles per hour or a greater reading is obtained with the master head at 30 miles per hour, the unit should be demagnetized down to 30 to 32 miles per hour with magnetizer (T-189785). Use the same 12-volt direct current source, obtaining the effect of an alternating field by running the speedometer on the tester at a master head speed of 30 miles per hour. Demagnetize by holding one pole of the magnetizer near the field plate and press button, immediately releasing it. When this is done it may be well to hold one finger between the field plate and the pole presented to it, thus preventing the magnetizer from being pulled into contact with the field plate, completely discharging the magnet. When unit is demagnetized below master head speed, it is necessary to start over again by first charging the magnet and then proceeding as outlined above.

f. **Complete the Calibration.** When accuracy is obtained at 30 to 32 miles per hour the unit should be checked at 10 miles per hour. Adjustment, up or down, at this point should be made only with the hair spring regulator arm to obtain reading of 9 to 11 miles per hour. Make final check for accuracy at the following speeds:

Master Head (mph)	Calibration Limits (mph)	Adjust With
10	9-11	Hair spring regulator arm
30	30-32	(Hair spring regulator arm
60	60-63	and demagnetizing.)

When checking calibration and pointer bank, it is permissible to tap the instrument lightly.

g. **Tachometer Calibration.** Follow the same method as outlined above except use the following chart, this chart being based on a 1 : 1

**ORDNANCE MAINTENANCE  
 SPEEDOMETERS, TACHOMETERS, AND RECORDERS**

ratio tachometer. If ratio of unit being checked is 2 : 1, multiply revolutions per minute limits shown by 2; if 3 : 1, multiply by 3, etc. Refer to chapter 13 for special information regarding the calibrating machine when used to check tachometers.

Master Head rpm		Tachometer rpm Calibration Limits	Adjust With
166	.....	160-175	..... Hair spring regulator arm
500	.....	500-525	.....
1,000	.....	1,000-1,050	.....
1,500	.....	1,500-1,550	.....
2,000	.....	2,000-2,050	.....
3,000	.....	3,000-3,050	.....

} Hair spring regulator arm  
and demagnetizing

**CHAPTER 4****AUTO-LITE SPEEDOMETERS AND TACHOMETERS****Section I****SPA SERIES****10. DESCRIPTION.**

a. This is a double-magnet type with hair spring mounted above the front jewel bracket, right-hand gears, and odometer mounted below the center of the dial. For complete description, operation and test procedure refer to previous paragraphs 2 and 4.

**11. DISASSEMBLY.**

a. **Remove Bezel.** Cut bezel with side cutters (fig. 51). Remove (fig. 52) and discard bezel, then remove glass and dial.

b. **Remove Case.** Remove two screws and lock washers from back of case, and lift out main frame assembly. Do not lose dust washer between main frame and case.

c. **Remove Pointer.** Remove needle-type pointers by holding pointer hub with fingers, twisting gently counterclockwise, and pulling off staff (fig. 78). On disk-type pointers hold speed cup from turning, and gently twist pointer from shaft.

d. **Remove Dial.** Remove two small screws from dial (grasp screwdriver firmly to avoid accidental scratching of dial.)

e. **Remove Odometer** (fig. 25). With screwdriver, remove bearing plate screw and locating plate screw. Take off bearing plate, locating plate, and odometer.

f. **Remove Hair Spring** (figs. 25 and 26).

(1) With chain nose pliers remove hair spring pin by placing one nose of pliers against small end of pin and other nose of pliers against end of hair spring regulator; gradually tighten pliers until pin is loose, then remove pin.

(2) Place jaws of puller (T-66296) under hair spring hub, and screw puller pin down against shaft until hair spring is loose. It is sometimes necessary to pry hair spring hub up slightly with lifter (T-29 Det 3) (fig. 27) to provide sufficient clearance for puller jaws.

g. **Remove Front Jewel Bracket Assembly** (fig. 33).

(1) With special screwdriver (T-178705) and wrench remove front jewel, lock nut and hair spring regulator.

(2) With screwdriver remove two bracket screws, and lift bracket from main frame.

h. **Remove Field Plate** (fig. 25). With screwdriver remove two screws and lock washers, and lift field plate and speed cup from main frame.



ORDNANCE MAINTENANCE  
SPEEDOMETERS, TACHOMETERS, AND RECORDERS

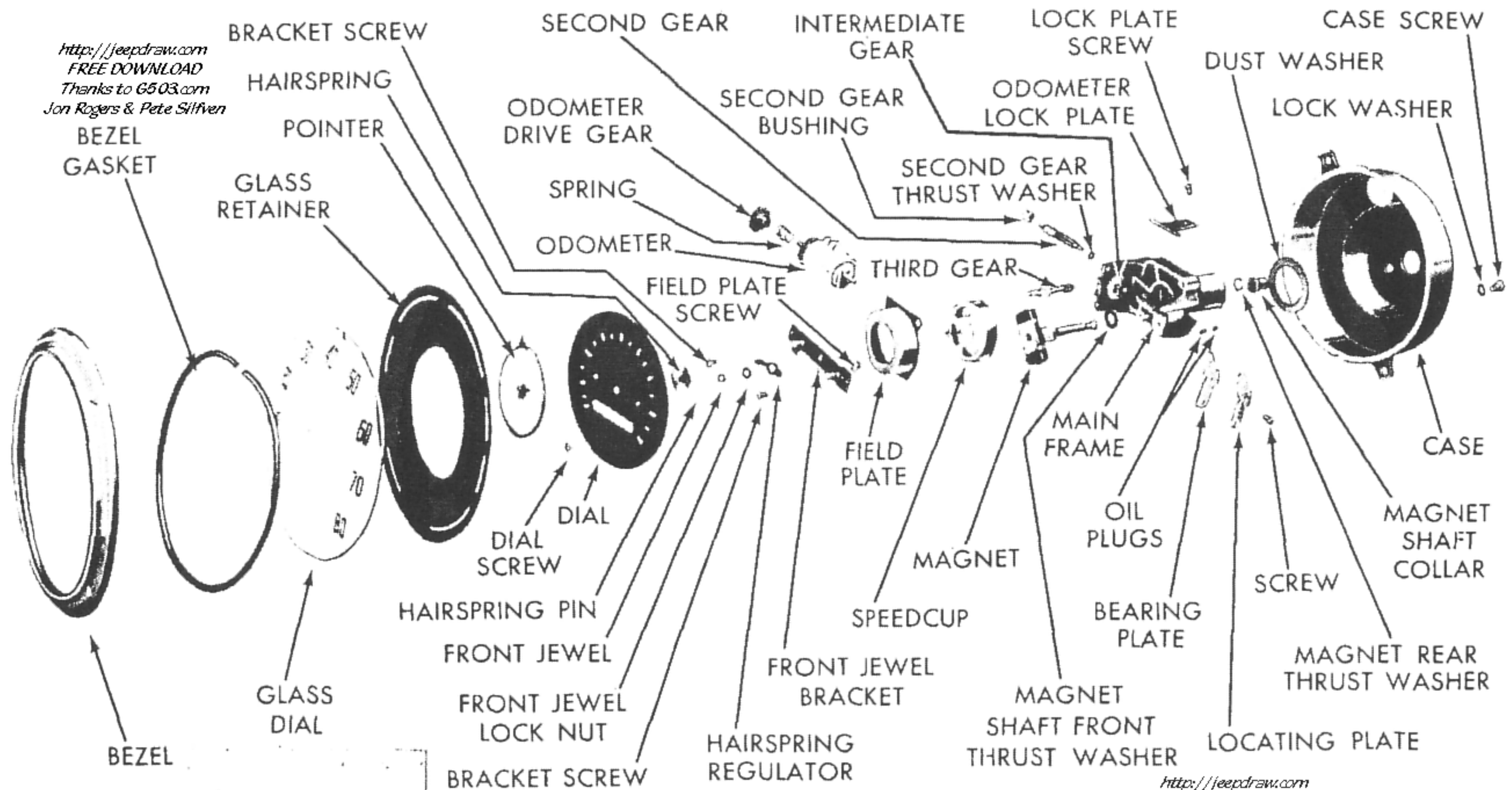

<http://jeepdraw.com>  
FREE DOWNLOAD  
Thanks to G503.com  
Jon Rogers & Pete Silfven

<http://jeepdraw.com>  
FREE DOWNLOAD  
Thanks to G503.com  
Jon Rogers & Pete Silfven

RA PD 318909

Figure 24—Auto-Lite Speedometer (SPA-type), Disassembled

SPA SERIES

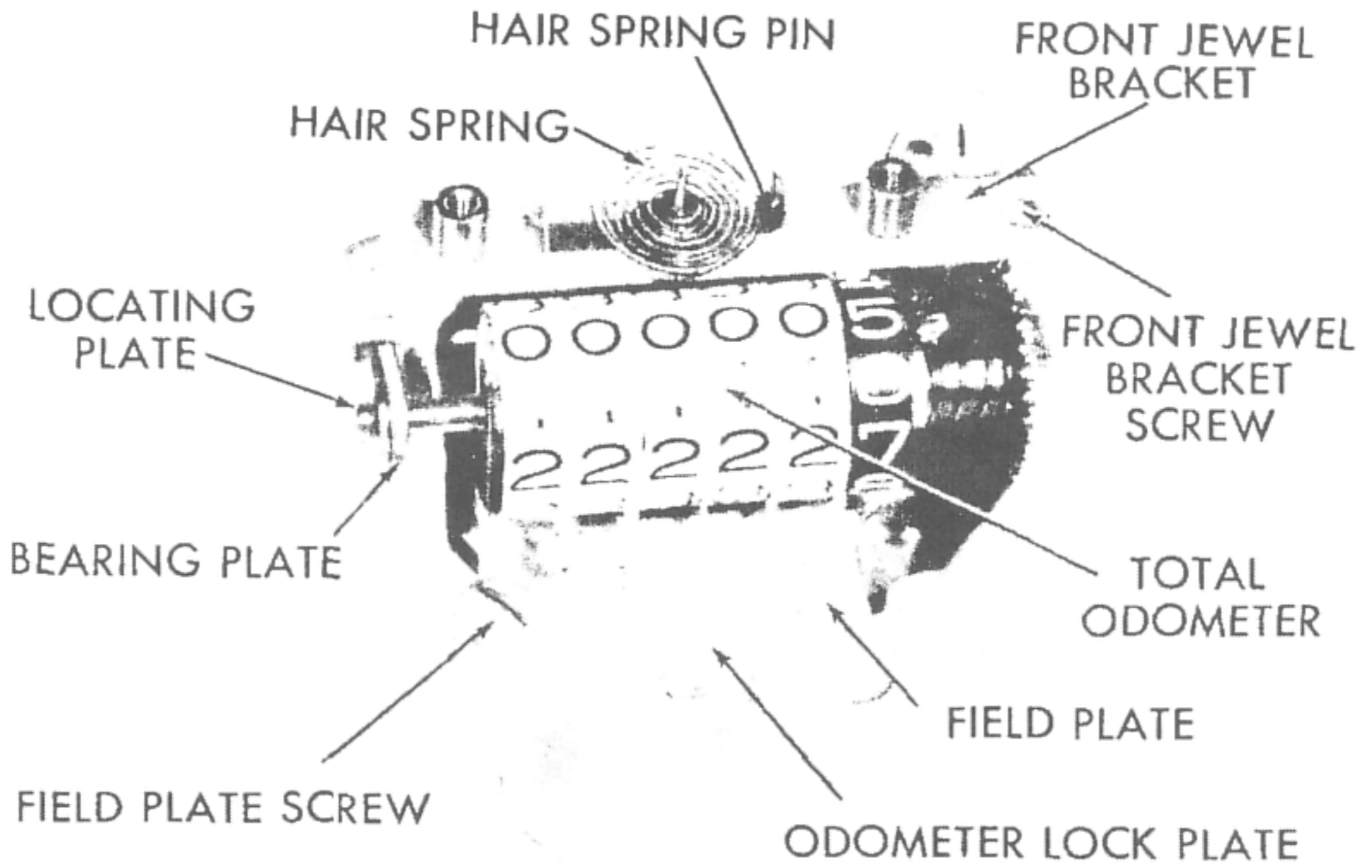

RA PD 318910

**Figure 25—SPA-type Speedometer Mechanism (Dial Removed)**

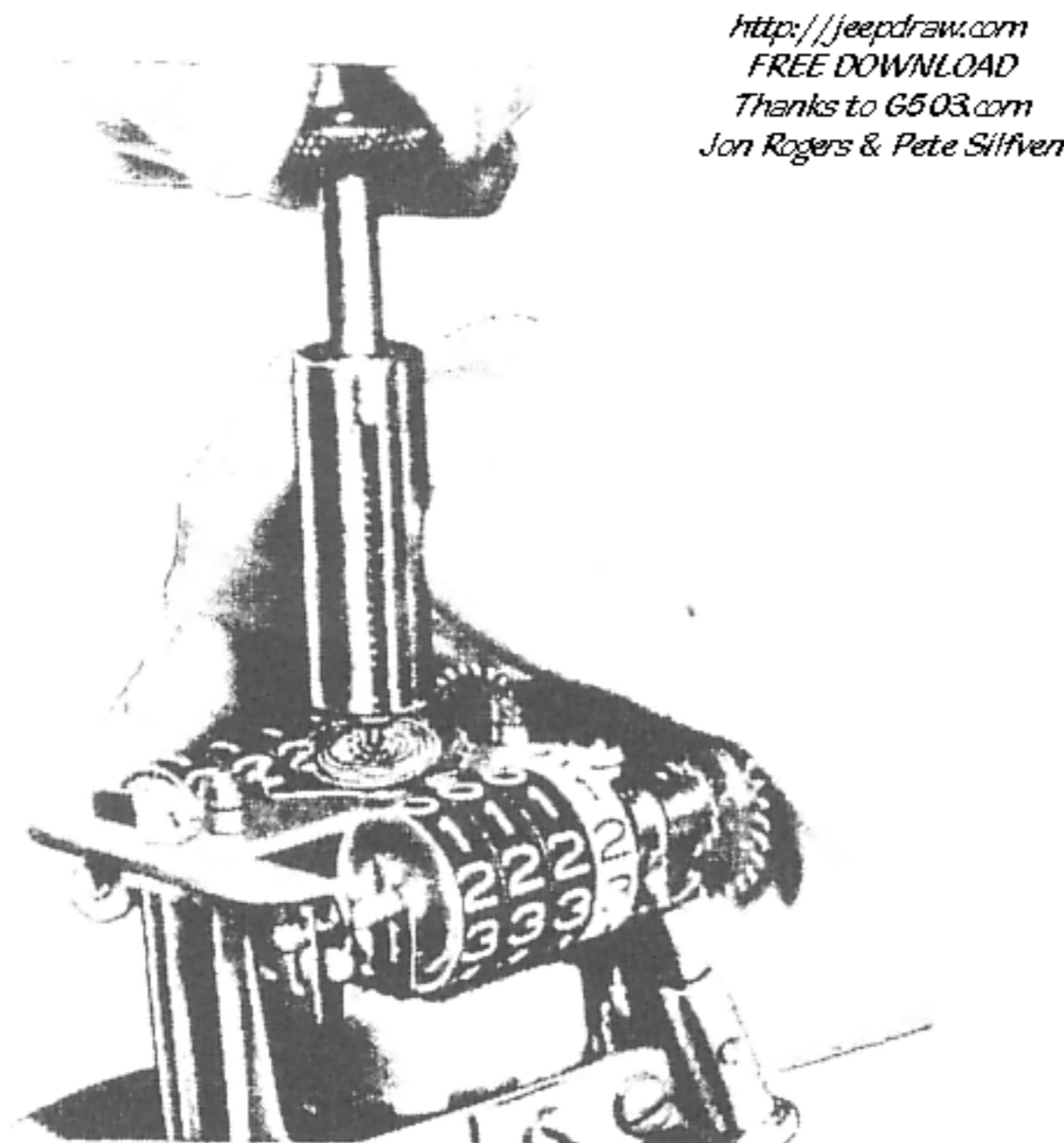

*http://jeepdraw.com  
FREE DOWNLOAD  
Thanks to G503.com  
Jon Rogers & Pete Silfven*

RA PD 318911

**Figure 26—Removing Hair Spring, Using Puller (T-66296)**

## ORDNANCE MAINTENANCE SPEEDOMETERS, TACHOMETERS, AND RECORDERS

**i. Remove Third Gear.** Lift third gear from its bushing, being careful not to lose any thrust washers that might be at either end of shaft.

**j. Remove Second Gear** (fig. 28). Remove by clamping main frame in vise with brass bushing of second gear pointing downward; tap with hammer and punch until gear is loose. When removing second gear, be careful not to lose any thrust washers that might be on either end of gear.

**k. Remove Magnet.** Screw tool (T-170654) into frame and tighten plunger against end of shaft (fig. 29).

**l. Remove Odometer Intermediate Gear.** Remove, if necessary, by grinding or filing off staked portion on outside of main frame with file, then drive out stud with hammer and punch.

**m. Remove Oil Wick Plug and Oil Wicks.** Place tang of screwdriver into hole of plug on an angle (not under flange), and force down on screwdriver lifting cover on one side until it can be removed. Remove wick with tweezers.

## 12. CLEANING, INSPECTION, AND REPAIR OF PARTS.

**a. General Cleaning.** After speedometer has been disassembled, thoroughly clean frame and intermediate gear, second gear, third gear, speed cup, field plate, hair spring, screws, metal washers, and brackets with brush and dry-cleaning solvent. In the cleaning process remove every trace of grease, dust or foreign matter of any kind. Only a thoroughly clean part will reveal defects such as wear, small cracks, and dents which might easily be hidden from view. After these parts have been cleaned, dry with compressed air, being careful not to damage hair spring. Wipe other parts clean with a cloth.

### **b. Inspection and Repair.**

(1) **CASE.** Inspect for dents, out-of-round condition, or for being damaged in any way.

(2) **MAIN FRAME.** Inspect for dents of any kind, such as small cracks, or rough bearing surface; be sure all threads are in good condition; if necessary, insert screws to test. Check for being out of line and make sure locating pins are in good condition.

(3) **MAGNET.** Inspect alinement and discard magnet if bent. Be sure both magnet bar and magnet clips are firm and solid, and that the gear teeth are in good condition. Install magnet in frame, and check amount of stock on end of magnet shaft to make sure there is enough to flare over when installing shaft and collar in main frame. Be sure rear jewel is clean.

(4) **GEARS.** Inspect for rough, worn or chipped teeth. Inspect bearing surfaces for roughness and excessive wear, and check for bent shaft.

(5) **FIELD PLATE.** Make sure plate is smooth both inside and outside, and that it seats firmly on main frame without touching or interfering with speed cup.

SPA SERIES

*http://jeepdraw.com*  
FREE DOWNLOAD  
Thanks to G503.com  
Jon Rogers & Pete Silfven



RA PD 318912

**Figure 27—Making Clearance for Hair Spring Puller with Lifter (T-29 Det 3)**

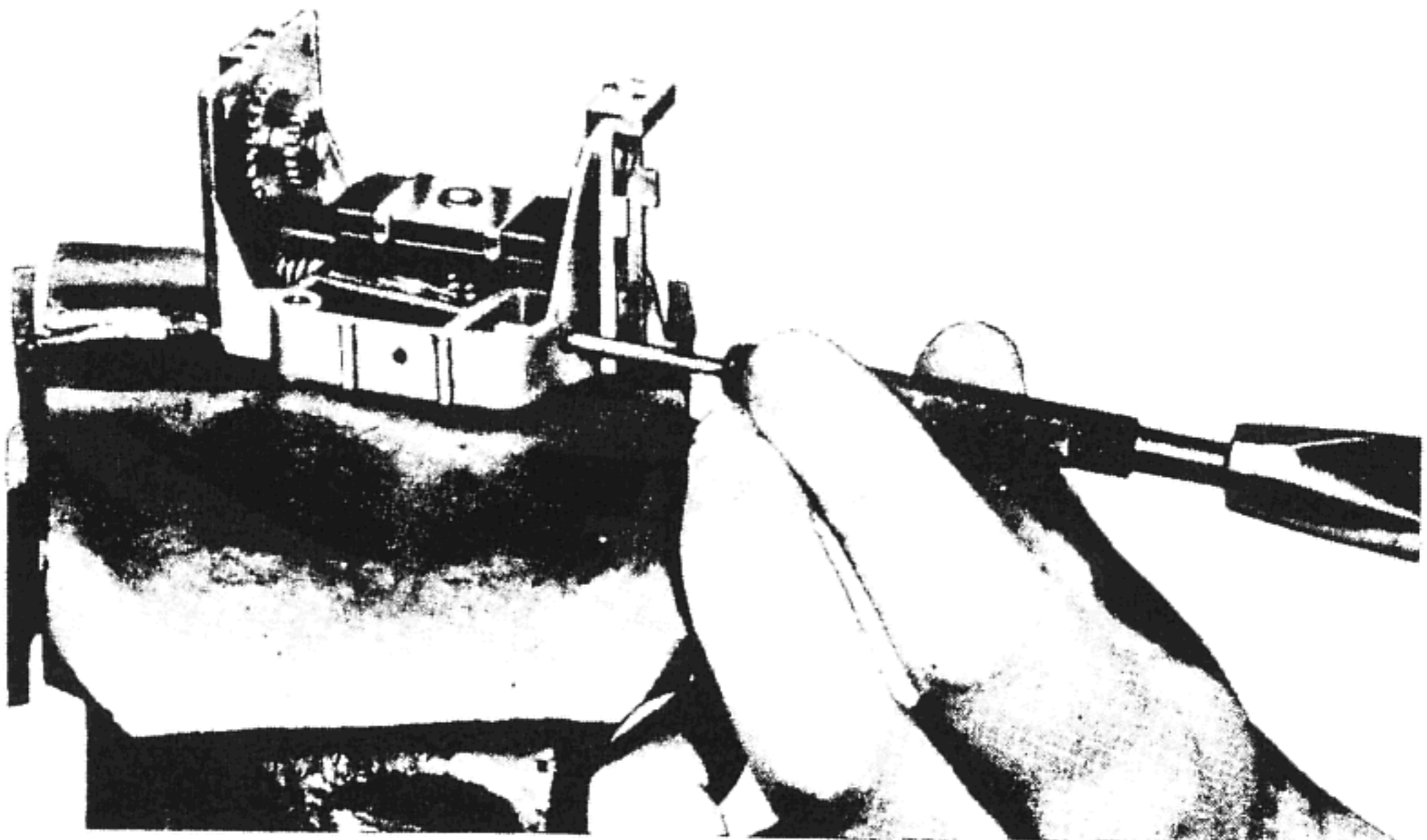

RA PD 318913

**Figure 28—Removing Second Gear**

## ORDNANCE MAINTENANCE SPEEDOMETERS, TACHOMETERS, AND RECORDERS

*http://jeepdraw.com  
FREE DOWNLOAD  
Thanks to G503.com  
Jon Rogers & Pete Silfven*

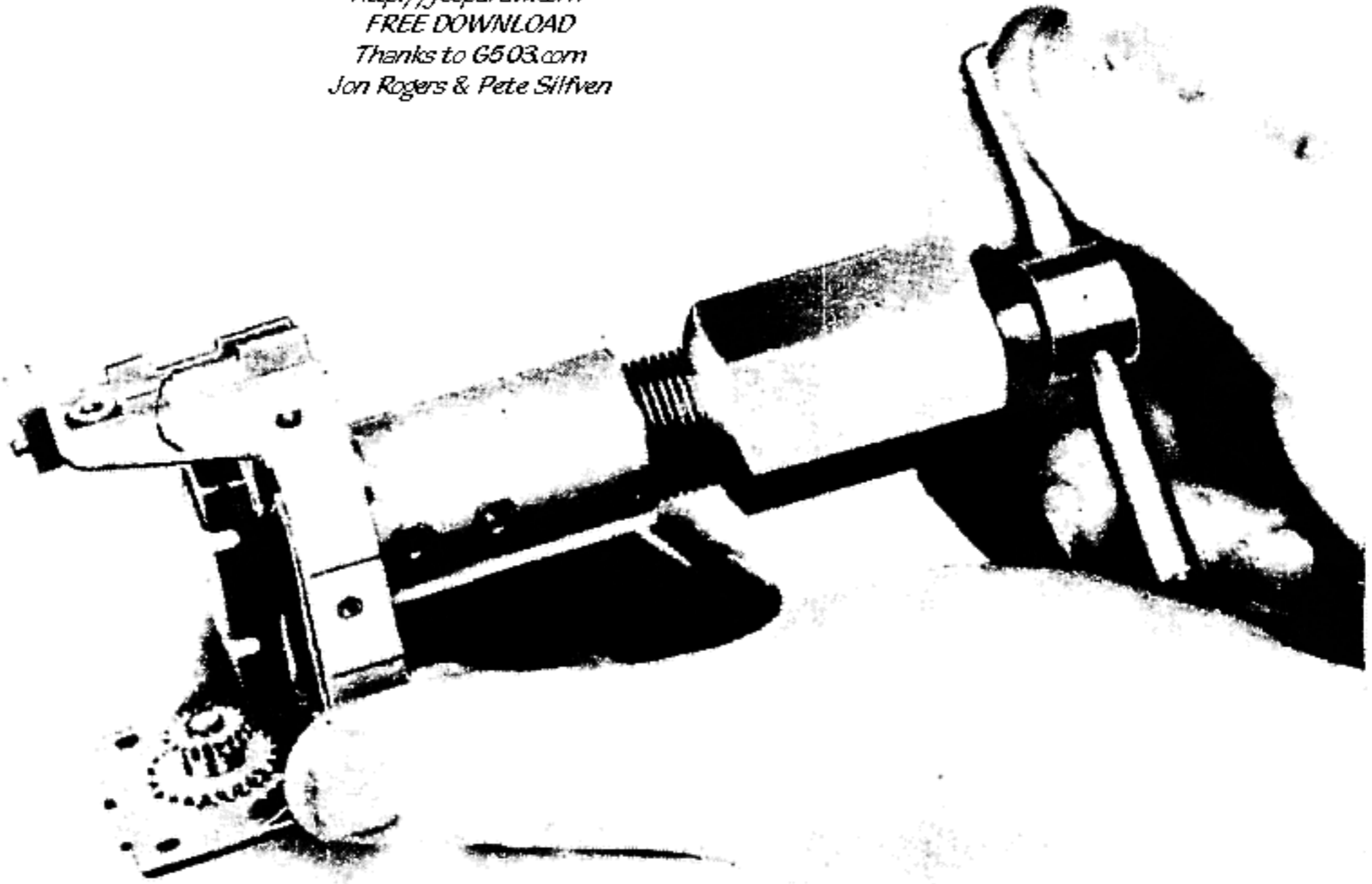

RA PD 318914

**Figure 29—Removing Magnet Shaft Collar, Using Dismantling Wrench (T-170654)**

(6) **SPEED CUP.** Lay speed cup staff on edge of smooth surface with large cup part extending over edge, and roll staff back and forth to detect a bent shaft. If staff is bent, install new speed cup. Examine lower end of speed cup staff, being sure it is not bent or broken.

(7) **FRONT JEWEL BRACKET.** Check for any out-of-line condition. Make sure threads are in good condition, also check threads on jewel, and check hair spring regulator for cracks and distortion, especially at the point where regulator is clamped by front jewel. Clean jewel, using a sharpened match or orange stick.

(8) **ODOMETER INTERMEDIATE GEAR.** Inspect for excessive looseness, worn or damaged teeth, cracks and distortion.

(9) **HAIR SPRING.** Hair spring must be perfectly flat, free from kinks, and the turns of spring must not touch each other at any point.

(10) **ODOMETER.** Inspect for free movement of figure wheels. Check also for chipped surfaces of figure wheels. If odometer is found defective replace entire unit.

(11) **MISCELLANEOUS PARTS.** Thoroughly inspect all miscellaneous parts not already specified in the above paragraphs for cracks, distortion, wear, stripped threads, and for other damage that would make the part unsuitable for use.

## SPA SERIES

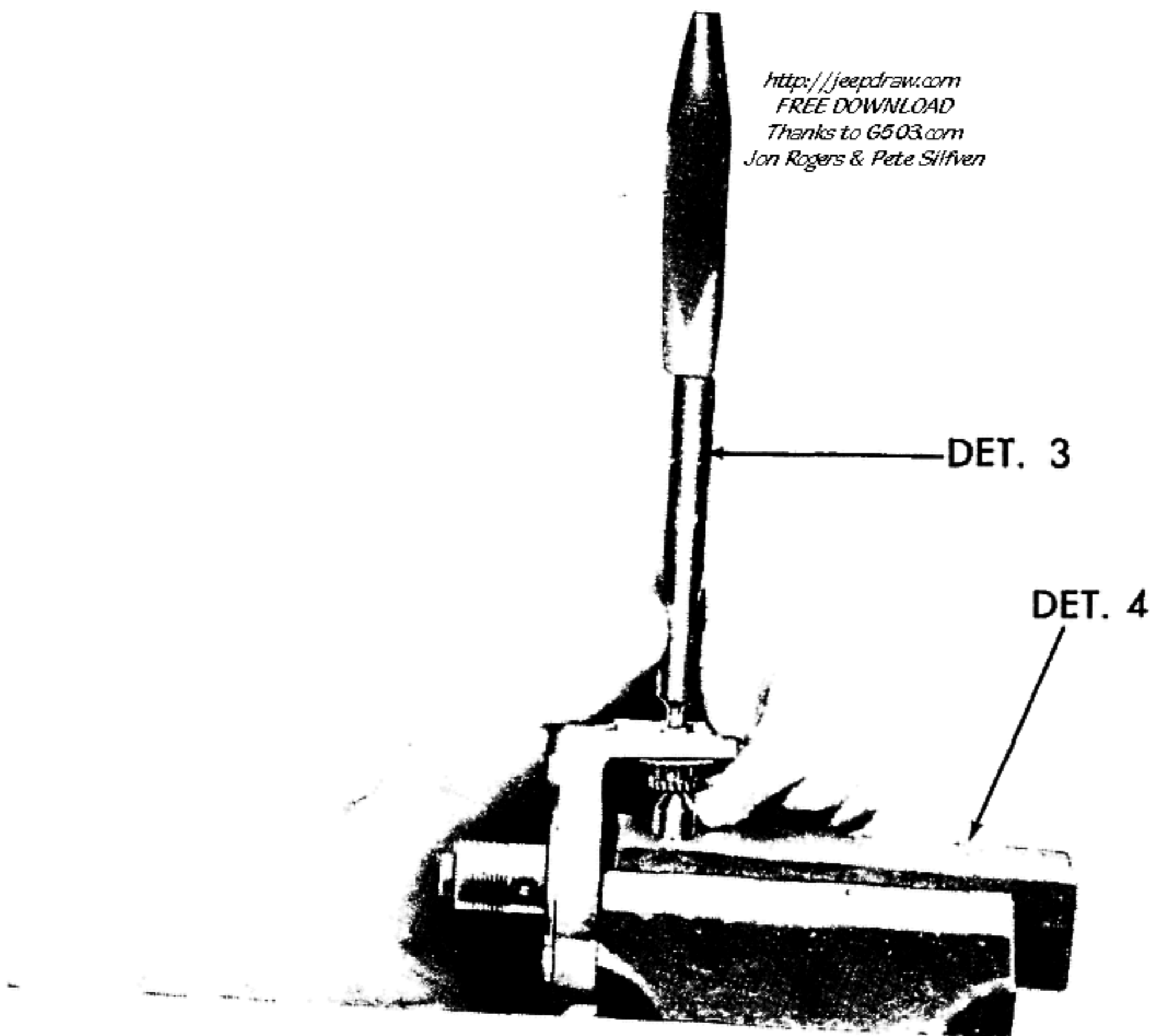

RA PD 318915

**Figure 30—Staking Intermediate Gear, Using Fixture (T-178717)**

### 13. ASSEMBLY.

a. **Install Odometer Intermediate Gear** (fig. 30). Clamp steel block (T-178717 Det 4) in vise; oil idler stud with watch and clock oil, and place intermediate gears and stud in position on main frame. Rest head of stud on steel block and, with punch (T-178717 Det 3) and hammer, stake over end of stud, making sure, when finished, that gears turn freely.

b. **Install Magnet.** Place thrust washer on shaft of magnet; apply slight amount of watch and clock oil on washer and magnet shaft. Insert magnet shaft in main frame, and place thrust washers in position on lower end of magnet shaft. Place collar on end of shaft with flanged end down and press into place (fig. 31). Flare end of shaft with tool (T-170666 with Det 6) (fig. 32). **NOTE:** *After assembling collar, if magnet is too tight for free rotation, loosen with special tool (fig. 29). Allow 0.003-inch end play.*

c. **Install Second Gear and Bushing.** Lightly clamp shank of main frame in vise. Place one drop of watch and clock oil on both ends of gear shaft. Place bushing on shaft with beveled end toward gear. Place thrust washer on other end of gear. Insert into frame,

**ORDNANCE MAINTENANCE  
SPEEDOMETERS, TACHOMETERS, AND RECORDERS**

*http://jeepdraw.com  
FREE DOWNLOAD  
Thanks to G503.com  
Jon Rogers & Pete Silfven*

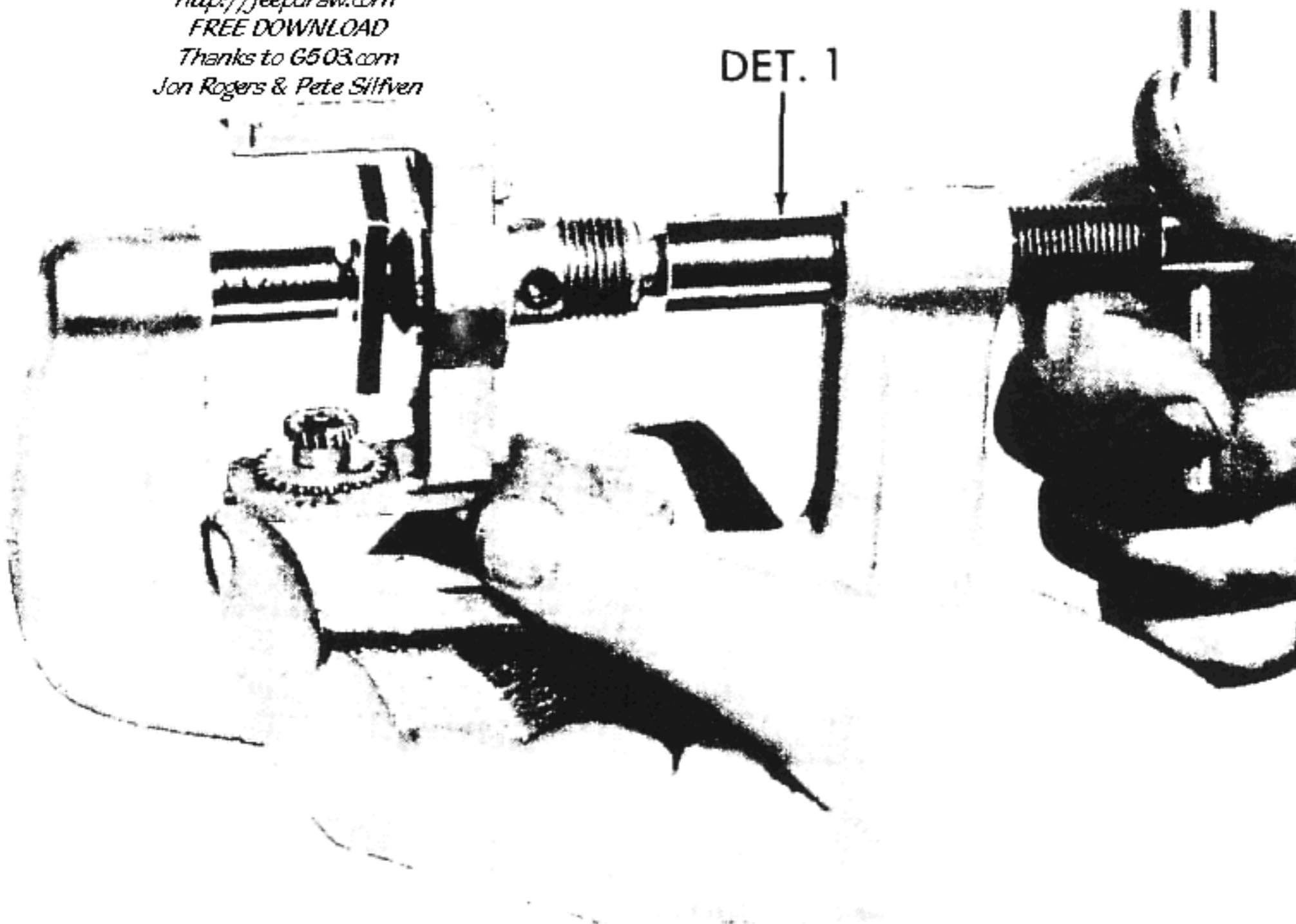

RA PD 318916

**Figure 31—Pressing Collar on Magnet Shaft, Using Fixture  
(T-170666 with Det 1)**

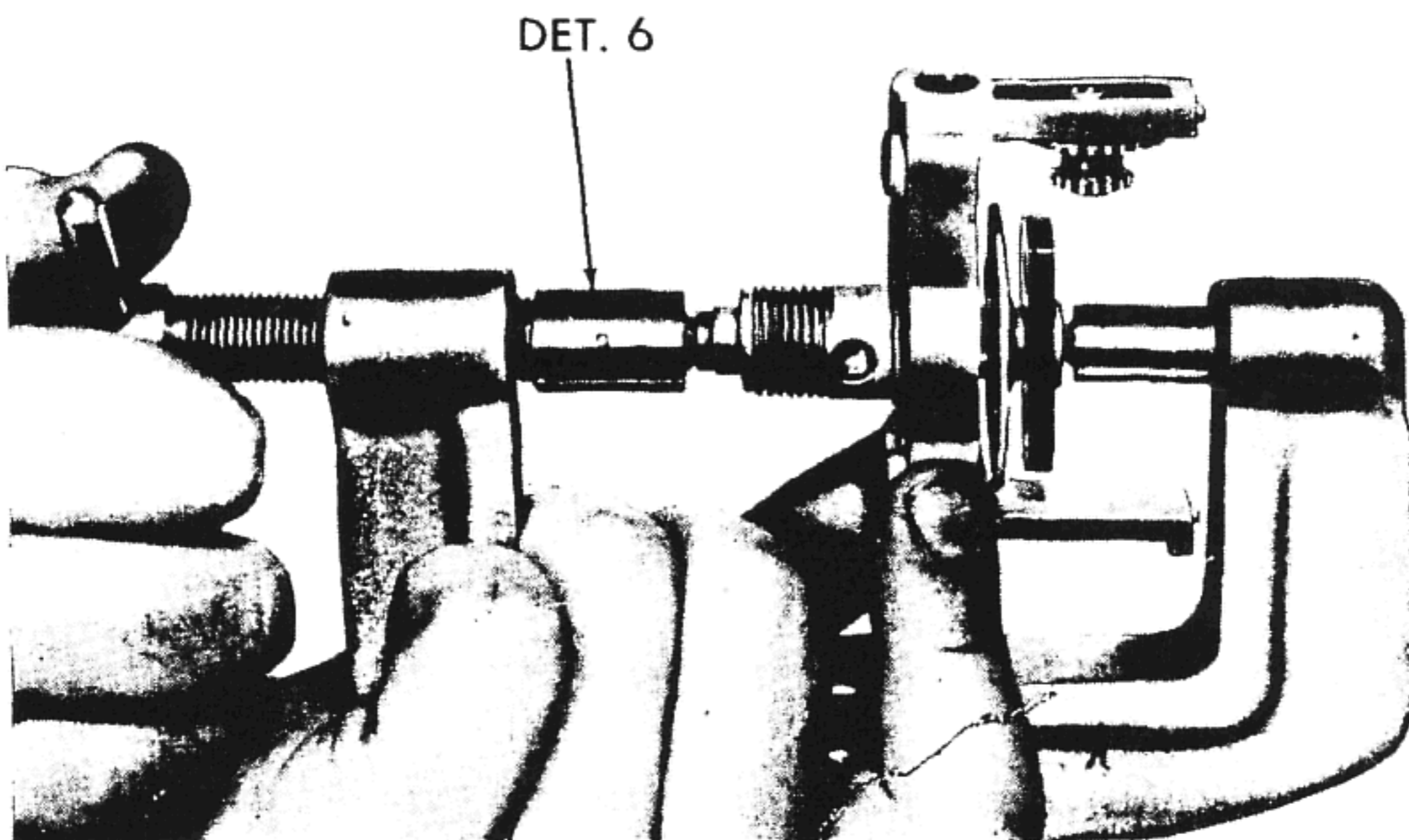

RA PD 318917

**Figure 32—Flaring Magnet Shaft, Using Fixture  
(T-170666 with Det 6)**

## SPA SERIES

*http://jeepdraw.com*  
 FREE DOWNLOAD  
 Thanks to G503.com  
 Jon Rogers & Pete Silfven

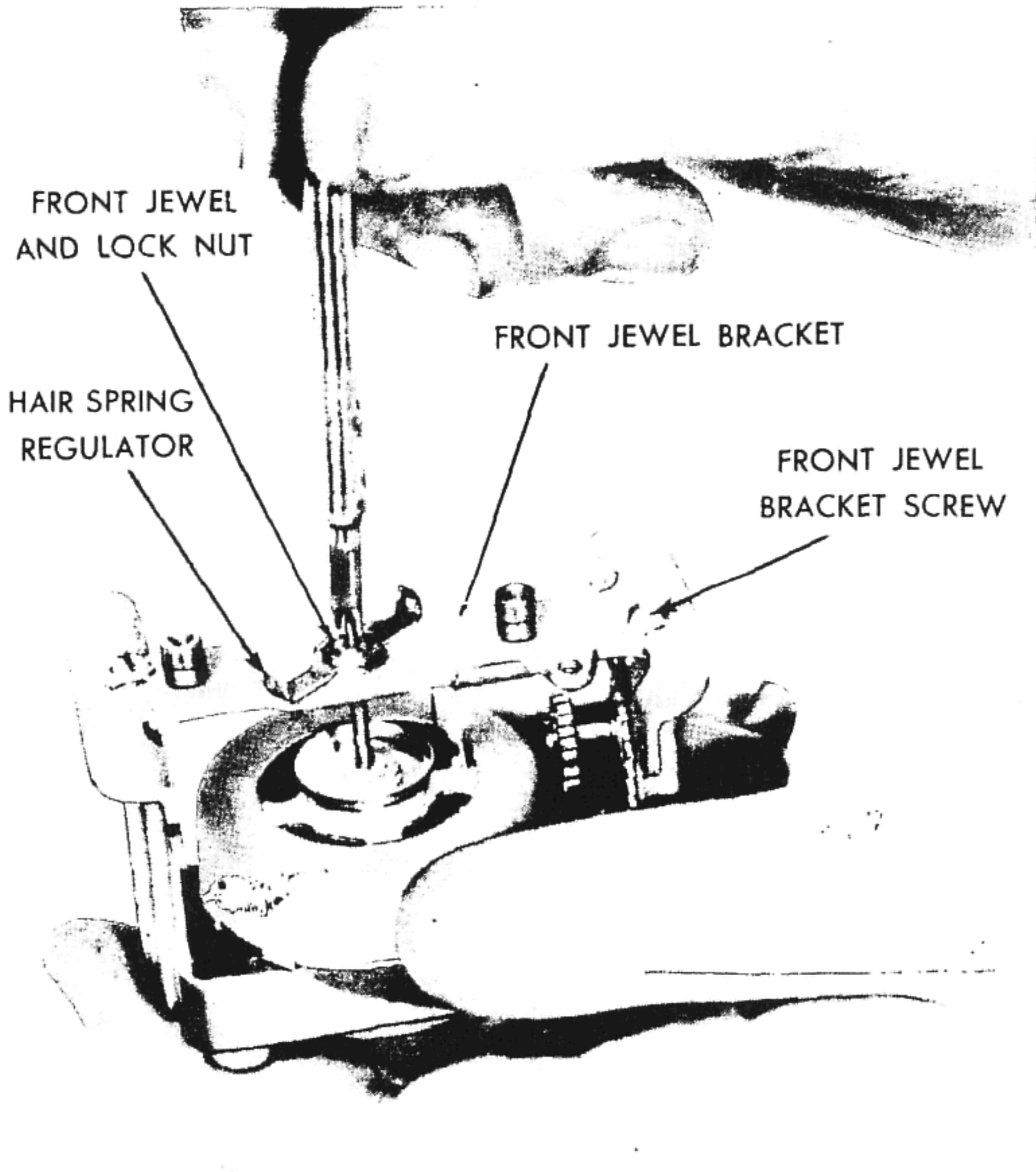

RA PD 318918

**Figure 33—Adjusting Front Jewel, Using Special Tool (T-178705)**

guiding gear into bushing in main frame with tweezers. Seat outer bushing by tapping. Stake frame over bushing with punch and hammer, spacing three staking points equally around bushing. Lubricate both gears sparingly with No. 00 Grease, O.D.

**d. Install Third Gear.** Grease third gear and insert lower end in bearing.

**e. Install Field Plate and Speed Cup.** Be sure lower staff jewel is clean. Place one drop of watch and clock oil on lower end of staff. Place speed cup over magnet, inserting lower end of staff into jewel



**ORDNANCE MAINTENANCE  
SPEEDOMETERS, TACHOMETERS, AND RECORDERS**

*http://jeepdraw.com  
FREE DOWNLOAD  
Thanks to G503.com  
Jon Rogers & Pete Silfven*

FEELER  
GAGE

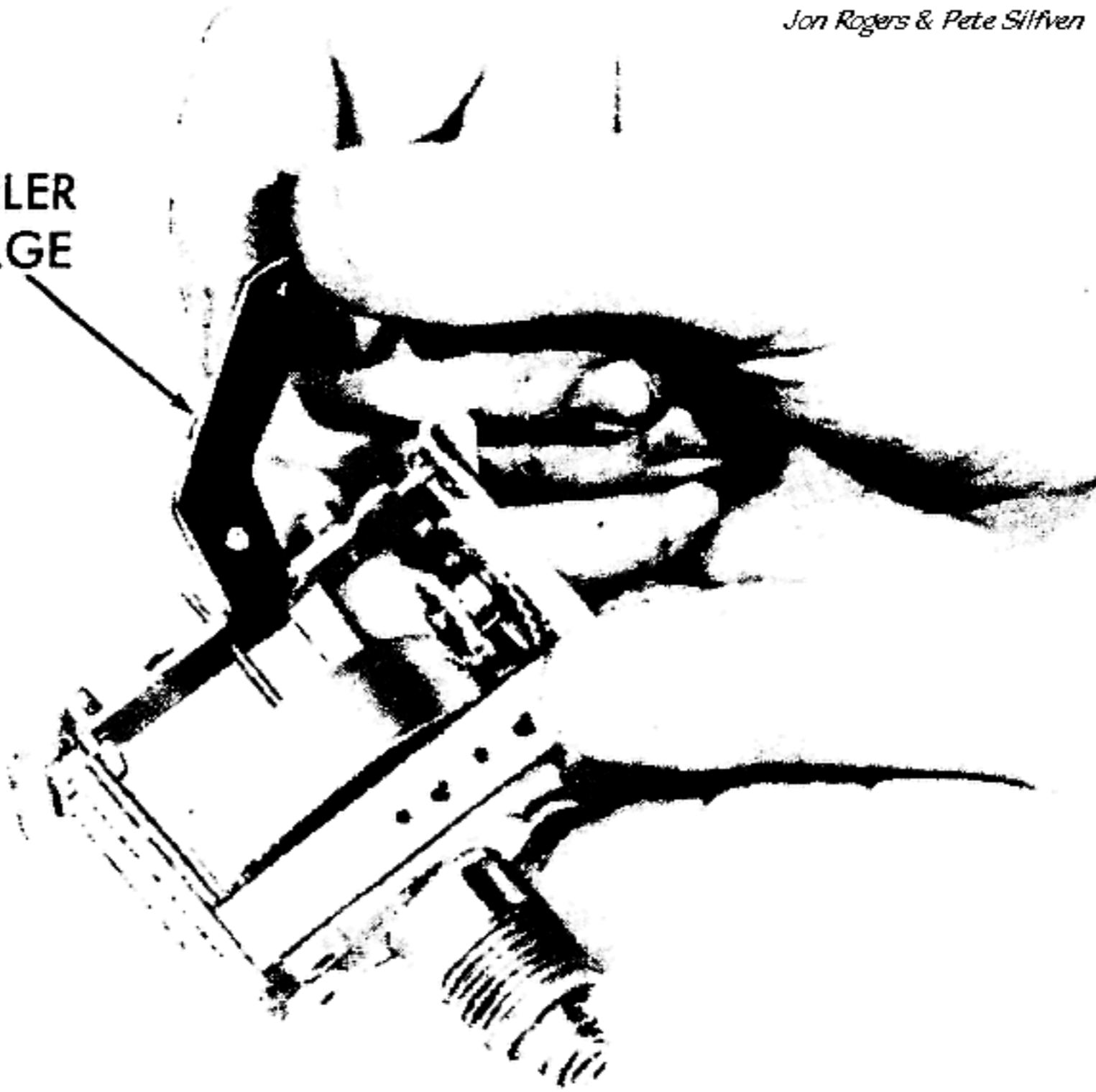

RA PD 318919

**Figure 34—Checking Speed Cup Staff End Play, Using Feeler Gage (ST-263-27)**

in magnet shaft. Place field plate over speed cup, tilting it so that flange goes under intermediate gear first. Install field plate screws and tighten securely.

f. **Assemble Front Jewel Bracket** (fig. 33). Place front jewel in bracket and screw in until lower end is even with under side of bracket. Place hair spring regulator over top of jewel with anchor end toward third gear hole. Install jewel adjusting lock nut with shoulder face down, being careful to enter shoulder into hair spring regulator.

g. **Install Front Jewel Bracket** (figs. 25 and 33).

(1) Put front jewel bracket in place on main frame. Enter speed cup staff into jewel. Enter top end of third gear into locating hole in bracket. Enter locating pin on main frame into locating hole in front jewel bracket. With front jewel bracket held in place, by hand, see that there is a small amount of end play in speed cup staff. **NOTE:** *If there is no end play, jewel must be backed out (fig. 33) until shaft is not tight when bracket is firmly in place.*

(2) Install front jewel bracket attaching screws and tighten.

## SPA SERIES

<http://jeepdraw.com>  
 FREE DOWNLOAD  
 Thanks to G503.com  
 Jon Rogers & Pete Silfven

(3) Adjust front jewel (fig. 33) so that there is 0.005 inch speed cup staff end play; hold feeler gage (ST-263-27) between under side of jewel and shoulder on speed cup staff (fig. 34); screw jewel down lightly without pressure until jewel touches gage. Hold jewel firmly in this position with tool (T-178705) and tighten lock nut. Check end play with feeler gage to see if tightening lock nut has altered adjustment.

**h. Install Hair Spring.** Handle hair spring carefully with tweezers and place on staff in such position that spring will wind up when staff is rotated in a clockwise direction. With female punch (T-29 Det 2) and hammer, tap spring hub lightly until loose end of spring is in the same plane as hole in regulator arm. When in this position hair spring hub will be approximately  $\frac{1}{32}$  of an inch above jewel. Insert end of hair spring in regulator and press lock pin into place with pliers. If hair spring does not lie in a true horizontal position, adjust by bending with tweezers at point where it engages lock pin. With proper care in this adjustment, spring can be made to lie flat and have uniform spacing of the coils. It is very important that this adjustment be properly made.

**i. Install Odometer** (fig. 25) (par. 11 e). Place clutch spring over odometer gear and clutch assembly. Put clutch on odometer shaft and engage clutch in odometer hub. *NOTE: Care must be taken so that alignment of odometer pinion carriers is not altered while doing this.* Oil odometer shaft with watch and clock oil, and insert clutch end of odometer shaft in bearing, holding odometer so that pinion carriers are toward palm of the hand with slots in carriers facing down. Place odometer bearing plate and locating plate on shaft in proper position on main frame, and insert screw through both plates into main frame. Tighten screw. Insert odometer locking plate into slots in pinion carriers on odometer, and fasten to main frame with screw.

**j. Install Face Dial.** Fasten dial to front jewel bracket with dial screws, taking care not to mar dial.

**k. Install Pointer.** Place pointer on staff in a position equivalent to one mile per hour below stop pin. Tap into place and then lift pointer over stop pin.

**l. Install Case.** (Do not install case until after calibration (par. 14).) Place main frame dust washer over neck of frame and insert in case. Turn to proper position and install and tighten screws and lock washers.

**m. Install Glass.** (Do not install glass until after calibration.) Before installing bezel and glass, be sure dial and glass are clean. Clamp shank of speedometer in vise. Fasten round rubber gasket to groove in bezel with shellac. Place large bezel gasket on face dial. Lay glass in position on gasket and put bezel in place. Invert speedometer and hold flat part of bezel so that it is between bead and edge, against edge of a wooden bench. Press down firmly, and tap lightly over the entire edge of bezel.

**n. Lubricate Magnet Shaft.** Place speedometer on calibrating machine (T-170645), run at 60 miles per hour and add 2 drops of

**ORDNANCE MAINTENANCE  
SPEEDOMETERS, TACHOMETERS, AND RECORDERS**

*http://jeepdraw.com  
FREE DOWNLOAD  
Thanks to G503.com  
Jon Rogers & Pete Silfven*

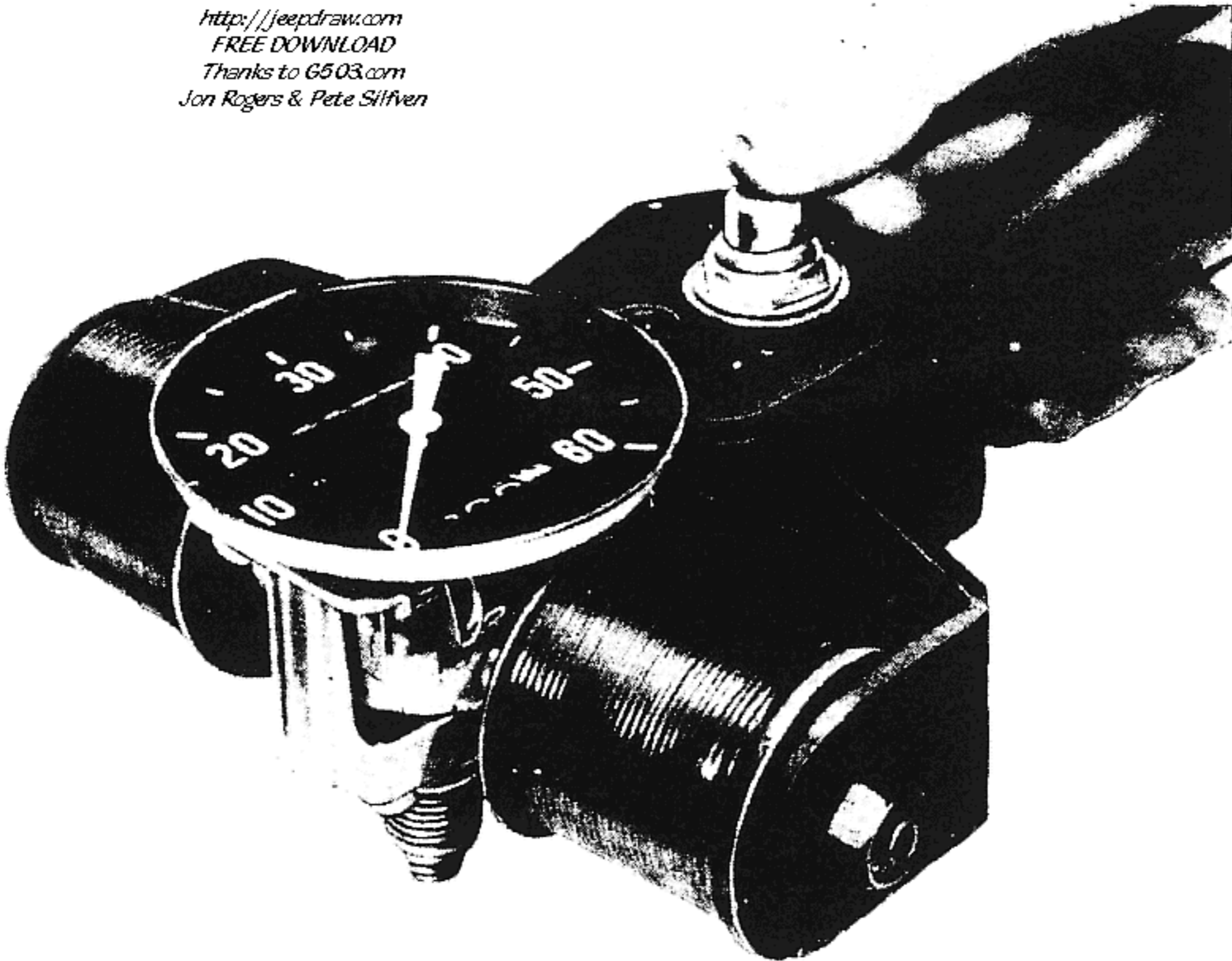

RA PD 318920

**Figure 35—Charging Magnet, Using Magnetizer (846294)**

SAE-10W oil to the oilhole. Saturate a short wick with SAE-10W oil, insert in oilhole and replace oil wick plug.

#### **14. CALIBRATION.**

a. **Check Pointer Position.** At this time pointer must already be assembled to staff so that it comes to rest at exactly zero or "no bank" as it is often called. To check this "no bank" position, bend pointer stop arm so that pointer can go two or three miles below zero, then hold speedometer in same position as when it is installed in the vehicle, and rotate it to right and then to left, enough to move pointer two or three miles off zero position. Hold speedometer still; if pointer does not come to rest at exactly zero, remove pointer (par. 11 c) and install in correct position (par. 13 k). Be sure this adjustment is correct before proceeding.

#### **b. Magnetizing.**

(1) Connect the magnetizer (846294) to a 12-volt direct current source. Clamp the magnetizer poles over the speedometer field plate, and press the magnetizer button firmly for two or three seconds.

**SPA SERIES**<http://jeepdraw.com>

FREE DOWNLOAD

Thanks to G503.com

Jon Rogers &amp; Pete Siffven

(2) With the speedometer mounted in the calibrating machine (T-170645) run the calibrating machine at 1,000 revolutions per minute (60 miles per hour) and the speedometer should indicate at least 70 miles per hour. If it does not indicate this speed, the magnet is insufficiently magnetized, and the magnetizing procedure (par. 14 b (1) above) should be repeated. It may be necessary to connect the magnetizer to a 24-volt source of direct current. On SPA-type speedometers, it may be necessary to remove odometer lock plate to ensure sufficient magnetization and demagnetization. **NOTE:** *Watches and any other electrical instruments which may be affected by magnetism should be kept at least 48 inches from magnetizer during this procedure.*

**c. Demagnetizing and Calibration (chapter 13).**

(1) When the speedometer is magnetized so that a speed of at least 70 miles per hour is indicated when master head indicates 1,000 revolutions per minute (60 miles per hour), then it should be demagnetized down to an indication in accordance with the specifications (par. 14 d). With the magnetizer connected to 12-volt direct current source, demagnetize by holding one pole of the magnetizer near (not touching) the speedometer field plate, and pressing magnetizer button (with the calibrating machine running at 60 miles per hour). It may be well to hold one finger between the field plate and the pole presented to it to prevent the pole from being pulled in contact with the field plate. Take care that the speedometer is not demagnetized below the desired speed. If speedometer is demagnetized below this speed it is necessary to again magnetize and demagnetize as outlined above.

(2) Run the calibrating machine at 30 miles per hour and note speedometer indication. Turn the speedometer 180 degrees by twisting the calibrating swivel joint connection, and check the speed indication. If all parts in the speedometer are balanced, the speed indication will not change. If the speedometer reads fast in new position, correct by placing a small amount of white lead in the balancing cup on top of the speed cup 180 degrees from the pointer. If there is no balancing cup, place white lead directly on speed cup, being sure to place it where it will not interfere with free operation. **NOTE:** *White lead is used because it hardens by oxidization without losing weight.*

(3) Recheck speedometer reading in both positions, and also by varying only 90 degrees from original position. When correctly balanced, speedometer indication will not vary from that shown in original position.

(4) Run calibrating machine at 167 revolutions per minute (10 miles per hour) and make any necessary adjustments at this speed by varying the position of the hairspring regulator so that the speedometer shows a reading as shown in specifications (par. 14 d).

(5) Check speedometer indications at 500 revolutions per minute (30 miles per hour) and 1,000 revolutions per minute (60 miles per

**ORDNANCE MAINTENANCE  
 SPEEDOMETERS, TACHOMETERS, AND RECORDERS**

hour). They should be within specifications (par. 23). If not, the process of magnetizing, demagnetizing and balancing should be repeated to obtain the desired calibration.

(6) Bend pointer stop to bring pointer exactly to zero. After correct calibration has been obtained there will be a calibrated bank of three miles per hour against the stop.

**d. Test Data.**

**(1) INDEX.**

Part No.	Test No.
SPA-4026 .....	1
SPA-4040 .....	2
SPJ-4001 .....	1
SPJ-4004 .....	2
SPK-4001 .....	3
SPK-4001A .....	3
SPK-4001B .....	3
SPK-4002 .....	3
SPL-4001 .....	1
SPM-4003 .....	2
SPP-4001 .....	4
SPR-4001 .....	3

**(2) TESTS.**

Master	MPH RPM	10	30	60	90	
		167	500	1000	1500	2000
Test 1 (miles)		9-11	28½-30½	61-63	93½-97	.....
Test 2 (miles)		8½-10½	28-30	60-62	92½-96	.....
Test 3 (miles)		9-11	30-32	60-63	.....	.....
Test 4 (revo- lutions per minute)		337-387	1010-1060	2020-2070	3030-3105	4040-4140

**e. Resetting Odometer.** Hold odometer in left hand, with tenth figure wheel to the right. Hold highest figure wheel between thumb and first two fingers, with pinion carrier between the two fingers. Turn the next figure wheel until correct figure on highest figure wheel is in proper position to show through opening in dial. Then move fingers along to hold pinion carriers for next figure wheel and proceed as above. Continue until desired total mileage is obtained, then reinstall odometer in front jewel bracket.

## CHAPTER 4

### AUTO-LITE SPEEDOMETERS AND TACHOMETERS (Cont'd)

#### Section II

### SPJ, SPL, AND SPM SERIES

*http://jeepdraw.com  
FREE DOWNLOAD  
Thanks to G503.com  
Jon Rogers & Pete Silfven*

#### 15. DESCRIPTION.

a. **General.** These are single-magnet types with hair spring mounted above the jewel bracket. SPJ-type has odometer below center of dial, and has a disk-type pointer. SPL-type has odometer in center of dial with needle-type pointer. All of these types have a revolving field plate. For complete description, operation, and test procedure refer to paragraphs 2 and 4.

#### 16. DISASSEMBLY.

a. **Remove Bezel.** Cut bezel and lift off bezel, gasket, glass and dial backer.

b. **Remove Case.** Remove two screws and lift off case and dust washer. Invert case and use as stand to hold speedometer while repairing.

##### c. Remove Pointer.

(1) On SPJ- and SPM-type use tool (T-29 Det 3). Slip paper over odometer and through window in dial. Insert curved end of tool under dial, and through window against bottom of pointer hub. Pry against hub, using odometer as a fulcrum. Keep hand over pointer, as it may snap off and become damaged.

(2) On SPL-type, remove pointer by holding pointer hub with fingers, twisting gently counterclockwise, and pulling off staff.

d. **Remove Dial.** Remove dial screws. Care must be taken to avoid slipping of screw slot and scratching dial.

e. **Remove Odometer (fig. 39).** Remove odometer spacing clip with pliers, grip flange of odometer shaft bushing with pliers and move bushing toward odometer figure wheels, then move same end of shaft forward until bushing is free of jewel bracket. Remove bushing and spring, then lift odometer assembly free from jewel bracket. If no work is contemplated on odometer, it is not necessary to remove odometer from jewel bracket. As these parts are a complete subassembly, the odometer can be removed with the bracket.

##### f. Remove Hair Spring (fig. 39).

(1) Remove lock pin by placing one nose of pliers against small end of pin and other nose against top part of arm on regulator. Tighten grip on pliers until pin is loose, then remove pin.

(2) Hook jaws of puller (T-66296) under hair spring hub. Screw downward on push pin with pin contacting end of staff (fig. 26). Increase pressure downward until hub pulls from staff. It may be

ORDNANCE MAINTENANCE  
SPEEDOMETERS, TACHOMETERS, AND RECORDERS

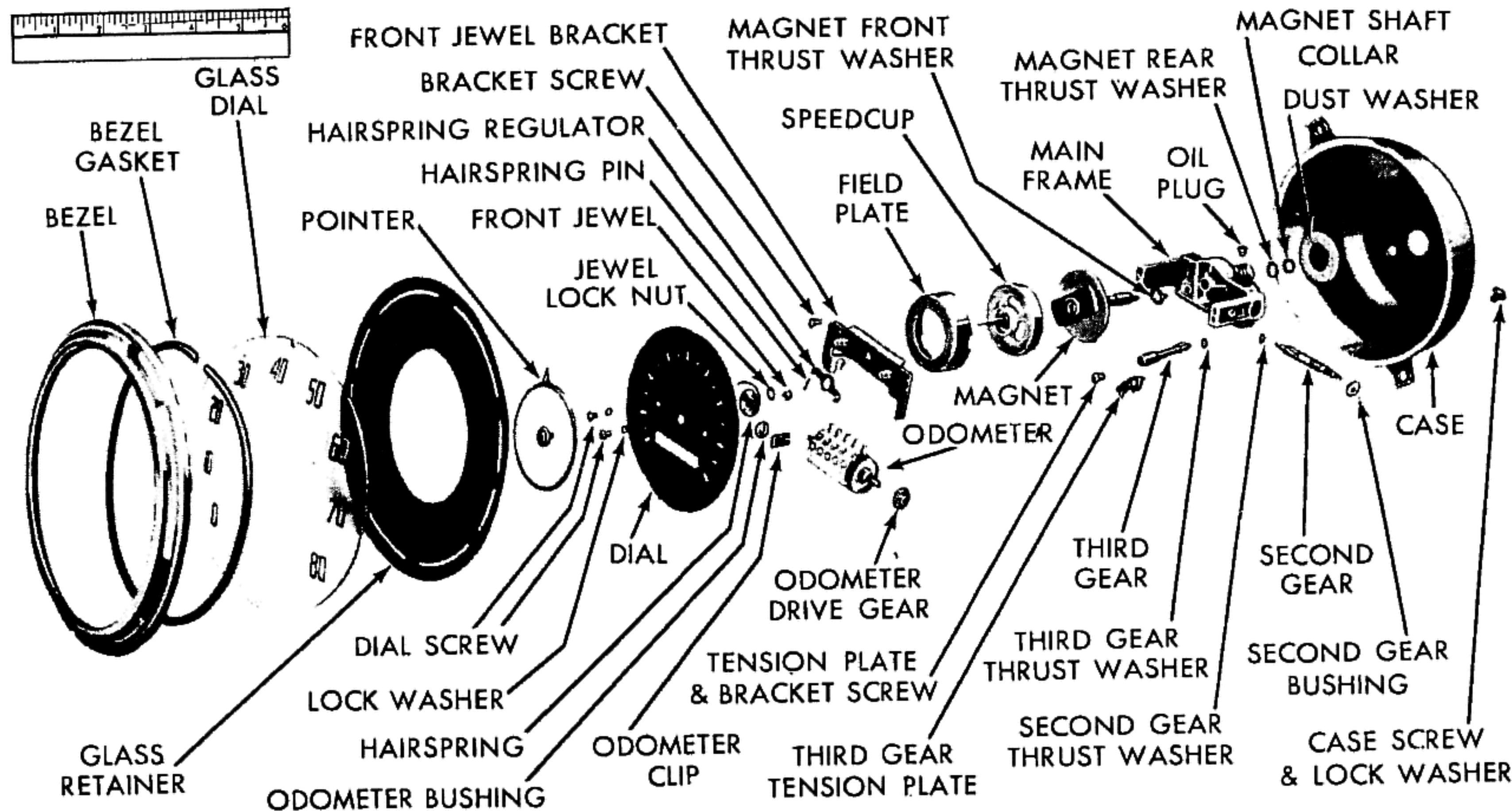

46

*http://jeepdraw.com*  
FREE DOWNLOAD  
Thanks to G503.com  
Jon Rogers & Pete Silfven

RA PD 318921

**Figure 36—Auto-Lite Speedometer (SPJ, SPL, and SPM-type), Disassembled**

## SPJ, SPL, AND SPM SERIES

necessary to pry hair spring hub up slightly to make clearance for the puller (fig. 27).

g. **Remove Front Jewel Bracket** (figs. 33 and 39). With screwdriver (T-178705) and wrench, remove jewel lock nut, hair spring regulator, and jewel. Take out two bracket screws and remove front jewel bracket. Do not lose third gear tension plate on SPL-type. Lift out third gear.

h. **Remove Field Plate and Speed Cup.** Hold assembly in inverted position. With pliers, grip each staked portion of field plate and turn outward slightly (fig. 40). Care must be taken to avoid cup distortion and to avoid turning stock out excessively. Best results are obtained by placing pliers so that side of nose lies flat against magnet plate. Lift off field plate and speed cup.

i. **Remove Second Gear** (fig. 41). Insert the lower bearing part of gear extracting tool (ST-263-34) in third gear bearing so that teeth of extracting tool mesh with second gear. Press tool against gear so that it will mesh deeply and turn tool clockwise, which will force second gear outer bearing from frame. Remove second gear, being careful not to lose any thrust washers which may be on gear shaft or stuck against inner bearing.

j. **Remove Magnet.** Check side play of magnet shaft. This must not exceed 0.003 inch. If side play is within limits, and magnet and shaft are in good condition, it will not be necessary to remove shaft. If it is necessary to remove shaft, screw tool (T-170654) on frame and tighten plunger against end of shaft (fig. 42). Remove collar, file burs from shaft and take magnet from frame. Do not drive magnet shaft through main frame bearing until all burs are filed smooth, so that shaft will pass through bearing freely without damaging it. Be careful not to lose thrust washers on either end of magnet shaft.

k. **Remove Intermediate Gears** (SPL-type). Do not remove intermediate gears from frame unless gears are worn, damaged, cracked or distorted. If these conditions are found, file or grind off staked portion of shaft on outside of main frame, and drive stud out of frame with hammer and punch.

## 17. CLEANING, INSPECTION, AND REPAIR OF PARTS.

a. The procedure for cleaning, inspection, and repair is the same as for the SPA series. Refer to paragraph 12.

## 18. ASSEMBLY.

a. **Install Magnet.** Place thrust washer on magnet shaft with tang toward main frame, so it will engage with one frame web to prevent it from turning. Insert magnet shaft in main frame, and place thrust washer and collar on end of shaft. Press collar into place with tool (fig. 31). Inspect shaft to make sure there is enough metal for proper flaring, then flare with special tool (fig. 32). When new magnet shaft is used, it may be necessary to use more than one



## ORDNANCE MAINTENANCE SPEEDOMETERS, TACHOMETERS, AND RECORDERS

thrust washer under collar. After flaring, measure magnet shaft end play with 0.002-inch feeler gage all around the entire magnet shaft to make sure it is not loose and there are no tight spots. Tighten with additional flaring if loose. If there is not enough clearance loosen with special tool (fig. 29).

b. **Install Second Gear.** Grease both bearing surfaces and teeth with No. 00 Grease, O.D. Place thrust washer on inner end of shaft and insert gear in main frame. Place outer bushing on shaft of gear with beveled side in and press second gear and bushing into frame. Adjust end play to 0.005 to 0.010 inch by installing thrust washers on shaft, then with tool (ST-263-35) stake edge of main frame against bushing at three places, equally spaced around bushing (fig. 43).

c. **Install Speed Cup.** Thoroughly clean lower staff jewel. Place one drop only of watch and clock oil on end of speed cup staff. Place speed cup over magnet, making sure lower end of staff enters jewel in top of magnet shaft.

d. **Install Field Plate.** Place field plate over speed cup, line up field plate and magnet, and clinch edges of plate with pliers. Make sure the assembly runs true after it has been assembled and that the field plate is tightly in place.

e. **Install Third Gear.** Grease lower bearing, place washer on lower end of shaft and insert in bearing.

f. **Assemble Front Jewel Bracket** (figs. 33 and 39). Screw jewel not more than three-quarters way into bracket. Place hair spring regulator over top of jewel with anchor end toward third gear bearing hole. Install jewel lock nut with shoulder face downward, being careful to enter shoulder into hair spring regulator. At this time clean jewel and end of speed cup staff.

g. **Install Front Jewel Bracket** (fig. 39).

(1) Install jewel bracket in its place on main frame, being sure to line up centering pins with holes in bracket, and at the same time guide third gear into its bearing. Install two holding screws, then make sure there is 0.005- to 0.010-inch play in third gear. Install third gear tension plate. **CAUTION:** *While tightening bracket screws make sure there is at no time a tightening down of the jewel against the speed cup staff.* (This condition will not exist if the jewel has been turned down three-quarters way or less as instructed in subparagraph f above.)

(2) End play in speed cup staff must be 0.003 inch, which is obtained by adjusting the total end play in speed cup and magnet shafts to 0.005 inch. Place a 0.005-inch feeler gage (ST-263-27) between front jewel and shoulder on speed cup staff (fig. 34). Hold lock nut with wrench and screw jewel down with special screwdriver (T-178705) until it comes lightly to rest on feeler gage. Tighten lock nut in this position. Recheck end play with 0.005-inch feeler

**SPJ, SPL, AND SPM SERIES**

gage to make sure this adjustment has not changed when tightening lock nut.

(3) A check of both bracket jewel adjustment and magnet shaft adjustment should be made at this time as follows: Holding speedometer in one hand, with thumb pushing up against bottom of magnet shaft, taking all end play out of magnet shaft, check the speed cup staff play with 0.003-inch feeler gage (ST-263-31). There should be 0.003-inch end play in speed cup staff, leaving 0.002 inch end play in magnet shaft, which is the correct adjustment or a total of 0.005 inch in both places.

**h. Install Hair Spring (fig. 39).**

(1) Rotate speed cup counterclockwise until it comes to rest against stop, then carefully place hair spring with tweezers on staff in such a position that when staff is rotated in a clockwise direction hair spring will wind up and when pinned there will be a slight tension holding speed cup stop against jewel bracket stop.

(2) With special drift (T-29 Det 2) and hammer, tap spring hub lightly until it is in the same plane as the hole in the regulator. This position will be approximately  $\frac{1}{32}$  inch above the jewel. Insert end of hair spring in regulator and press lock pin in with pliers. If hair spring does not lie in a true horizontal position, adjust by bending with tweezers, at a point where it engages lock pin. Be sure the turns of the hair spring do not touch each other in this position. With proper care in this adjustment, spring can be made to lie flat and have uniform spacing of coils. **NOTE:** *It is very important that this adjustment be properly made.*

**i. Install Odometer (fig. 39).** Aline pinion carriers for proper engagement with jewel bracket. Insert gear end of shaft in jewel bracket and move toward bracket, completing engagement of pinion carriers with jewel bracket. Move opposite end of odometer sufficiently to replace spring and bushing on shaft. Grip flange of bushing with pliers and move toward odometer to compress spring, then swing inward until bushing snaps into place in bracket bearing. Make sure all pinion carriers are properly engaged with jewel bracket. Install odometer shaft clip. Oil odometer bearings with watch and clock oil.

**j. Install Dial.** Fasten dial to front jewel bracket mounting supports. Do not let screwdriver slip and mar dial.

**k. Install Pointer.** Bend the pointer stop arm slightly back of zero position. Hold speedometer in same position it will be on vehicle, float pointer exactly on zero, and tap into place.

**l. Calibrate.** Refer to paragraph 14.

**m. Install Case.** (Do not install until after calibration.) Install main frame dust washer and insert speedometer in case. Turn to position and install two screws and lock washers with screwdriver.

**n. Install Bezel and Glass.** Put washer and glass in place, then crimp edge of bezel, tapping lightly with small hammer as speedometer rests against wooden block.

**ORDNANCE MAINTENANCE**  
**SPEEDOMETERS, TACHOMETERS, AND RECORDERS**

**CHAPTER 4**

**AUTO-LITE SPEEDOMETERS AND**  
**TACHOMETERS (Conf'd)**

**Section III**

**SPK, SPP, AND SPR SERIES**

*http://jeepdraw.com*  
*FREE DOWNLOAD*  
*Thanks to G503.com*  
*Jon Rogers & Pete Silfven*

**19. DESCRIPTION.**

a. The SPK speedometer (fig. 37) is a single-magnet type with hair spring mounted above the front jewel bracket, odometer mounted above center of dial, trip odometer below center of dial, and with revolving field plate. Dial is black with white figures reading from 0 to 60 miles per hour. Pointer is needle-type, and is white. Trip odometer reset is the solid-rod type.

b. The SPR speedometer (fig. 37) is a single-magnet type with the hair spring mounted above the front jewel bracket, odometer mounted above center of dial, trip odometer below center of dial, and with revolving field plate. They have needle-type pointers and flexible reset shafts.

c. The SPP tachometer is a single-magnet type with the hair spring mounted above the front jewel bracket. Total odometer is mounted below center of dial. It has no trip odometer and no reset assembly. For complete description, operation, and test procedure refer to paragraphs 2 and 4.

**20. DISASSEMBLY.**

a. **Remove Bezel and Glass.** Cut bezel and remove bezel, glass, gaskets, and dial retainer.

b. **Remove Case.** Remove mounting bracket and unscrew reset knob or flexible cable. Remove two case screws, remove case, being careful not to lose main frame dust washer, and on SPK-type, be careful not to lose felt washer on reset mechanism.

c. **Remove Pointer.** Grasp pointer firmly at center, being careful not to bend it, twist slightly counterclockwise, and pull to remove.

d. **Remove Dial.** Remove dial screws, being careful not to mar dial, and lift off dial.

e. **Remove Trip Odometer Reset Bracket** (fig. 39). Remove two screws and lift off. Case can be placed on bench in inverted position and used as a stand for main frame during disassembly.

f. **Remove Odometer** (fig. 39). Remove total odometer spacer clip. Move bushing out of bearing slot, at same time pulling odometer pinion carriers from front jewel bracket until they clear bracket. Repeat to remove trip odometer.

g. **Remove Hair Spring** (fig. 39).

(1) Place one nose of pliers against small end of locking pin and other nose against upper part of regulator, gently tighten pliers to

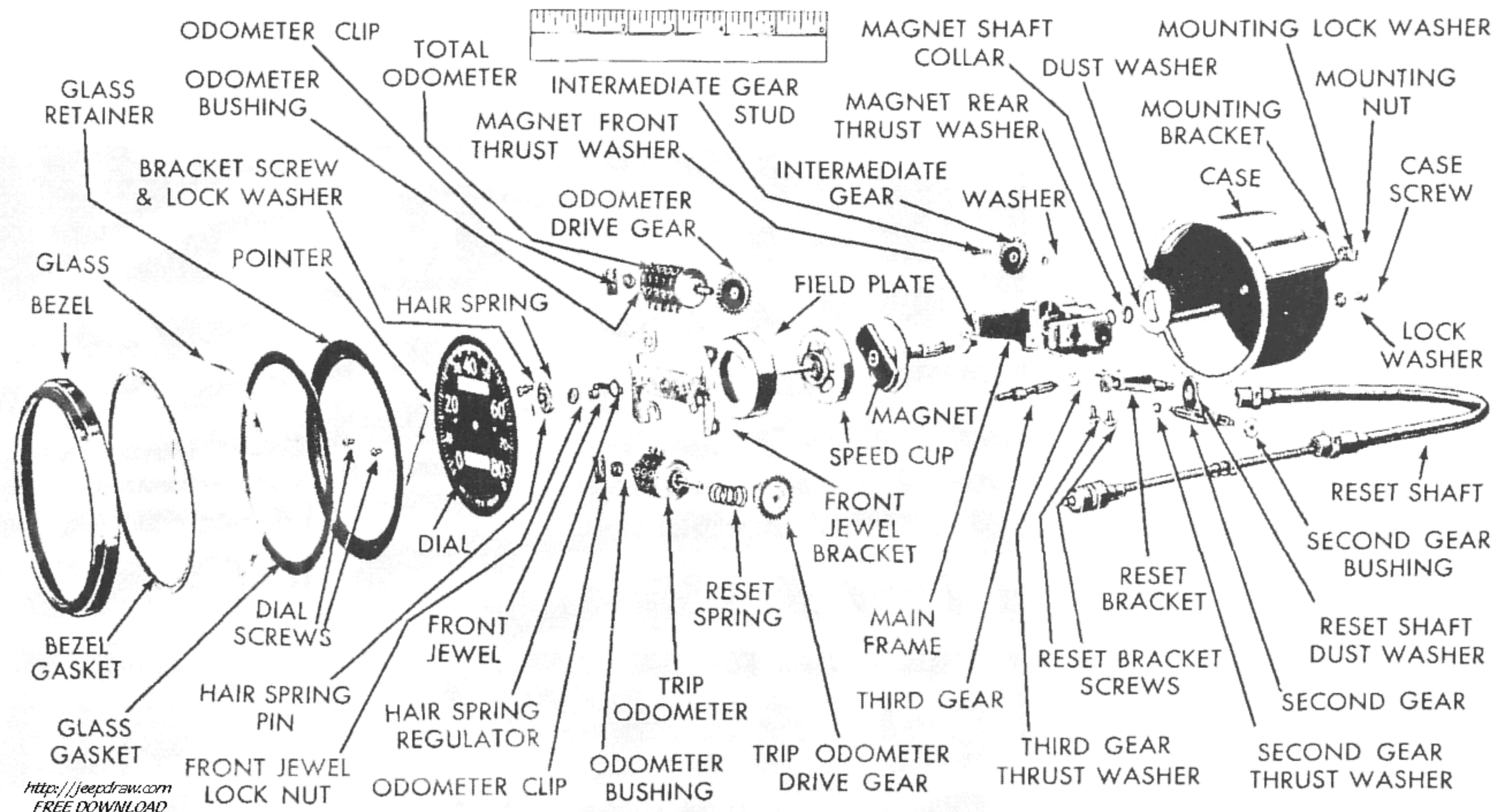

51

<http://jeepdraw.com>  
FREE DOWNLOAD  
Thanks to G503.com  
Jon Rogers & Pete Silfven

RA PD 318922

Figure 37—Auto-Life Speedometer (SPK- and SPR-types), Disassembled

ORDNANCE MAINTENANCE  
SPEEDOMETERS, TACHOMETERS, AND RECORDERS

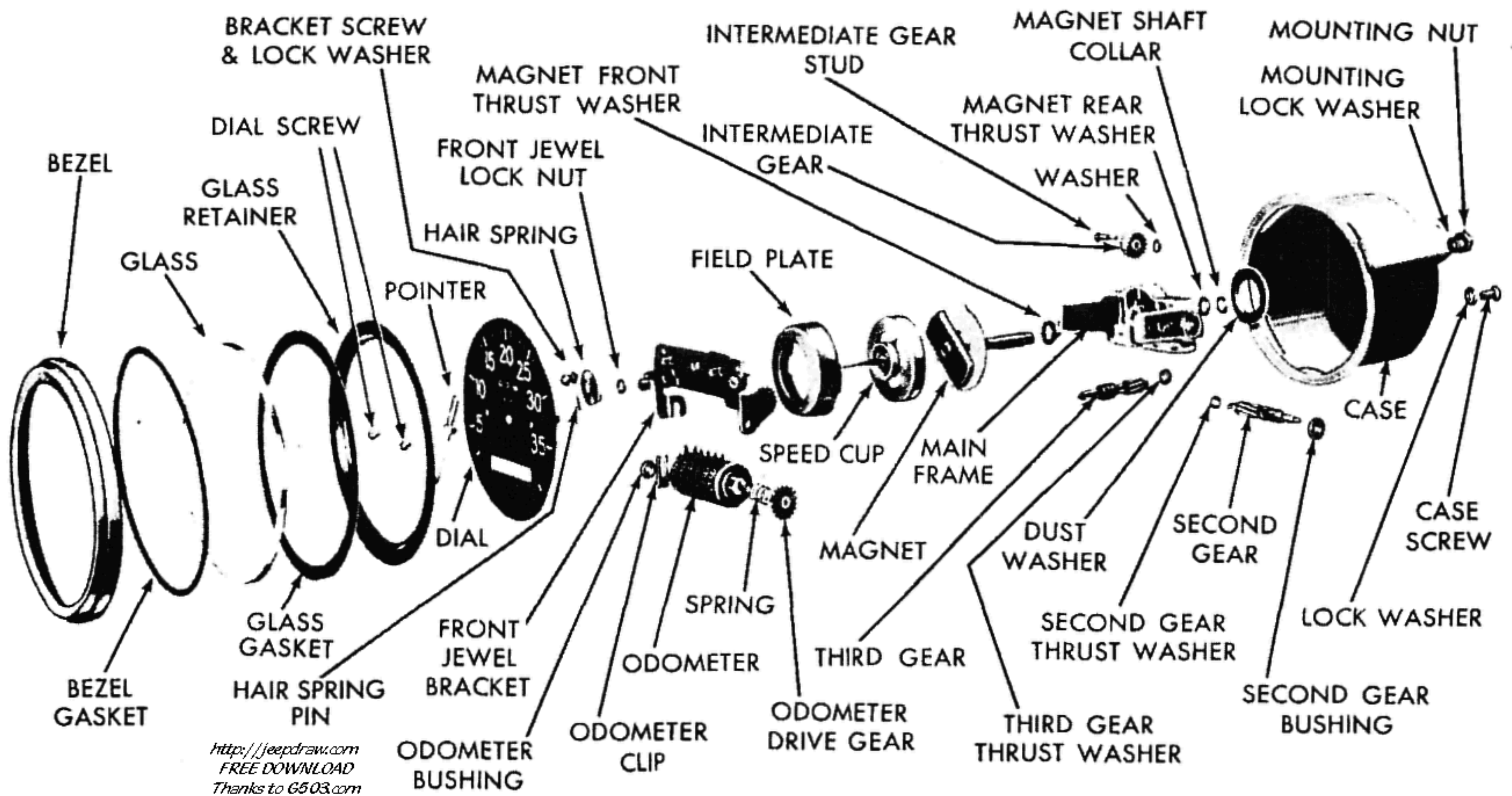

<http://jeepdraw.com>  
FREE DOWNLOAD  
Thanks to G503.com  
Jon Rogers & Pete Silfven

RA PD 318923

Figure 38—Auto-Lite Tachometer (SPP-type), Disassembled

## SPK, SPP, AND SPR SERIES

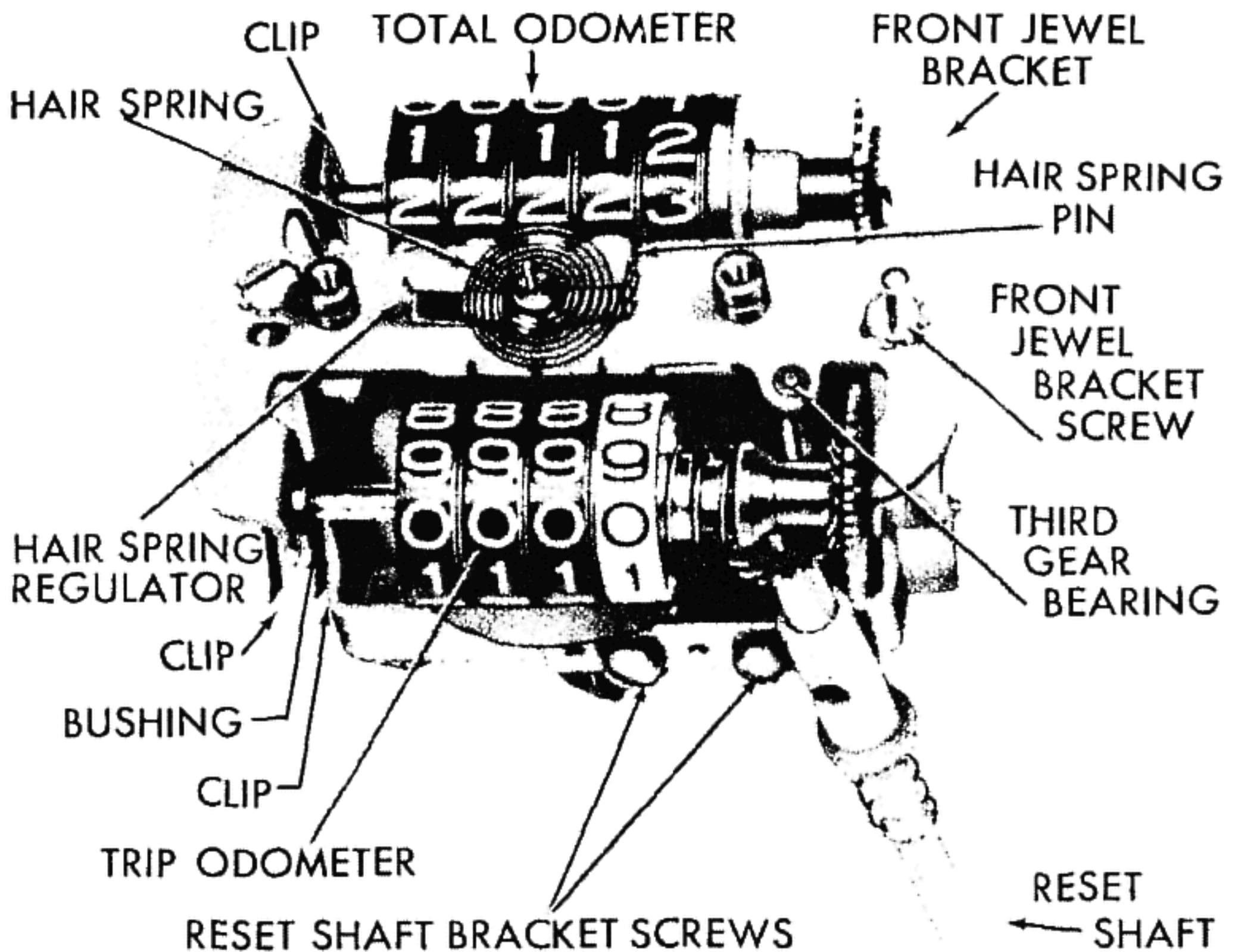

*http://jeepdraw.com*  
 FREE DOWNLOAD  
 Thanks to G503.com  
 Jon Rogers & Pete Silfven

RA PD 318924

**Figure 39—SPK-type Speedometer Mechanism (Dial Removed)**

remove pin, then rotate speed cup until end of hair spring is free from regulator.

(2) Remove hair spring with special puller (T-66296); slide lower plate of puller between hair spring hub and jewel lock nut, and tighten puller screw (fig. 26). It may be necessary to pry hair spring hub up slightly (fig. 29) to make clearance for puller.

**h. Remove Front Jewel Bracket** (figs. 33 and 39). With special screwdriver (T-178705) and wrench remove lock nut, regulator, and jewel. Remove two bracket screws and lift off bracket.

**i. Remove Third Gear.** Remove third gear; do not lose any washers which may be at either end of gear.

**j. Remove Speed Cup and Field Plate** (fig. 40). Hold main frame in inverted position and straighten out crimping at lower edge of field plate, and lift off both speed cup and field plate.

**k. Remove Second Gear** (fig. 41). Insert lower bearing part of extracting tool (ST-263-34) in lower third gear bearing so that gears of extracting tool mesh with second gear. Press tool against gear so that it will mesh deeply and turn clockwise, forcing second gear outer bushing from main frame. When removing second gear, be careful not to lose any thrust washers which may be on shaft or sticking to inner bearing.

**ORDNANCE MAINTENANCE  
SPEEDOMETERS, TACHOMETERS, AND RECORDERS**

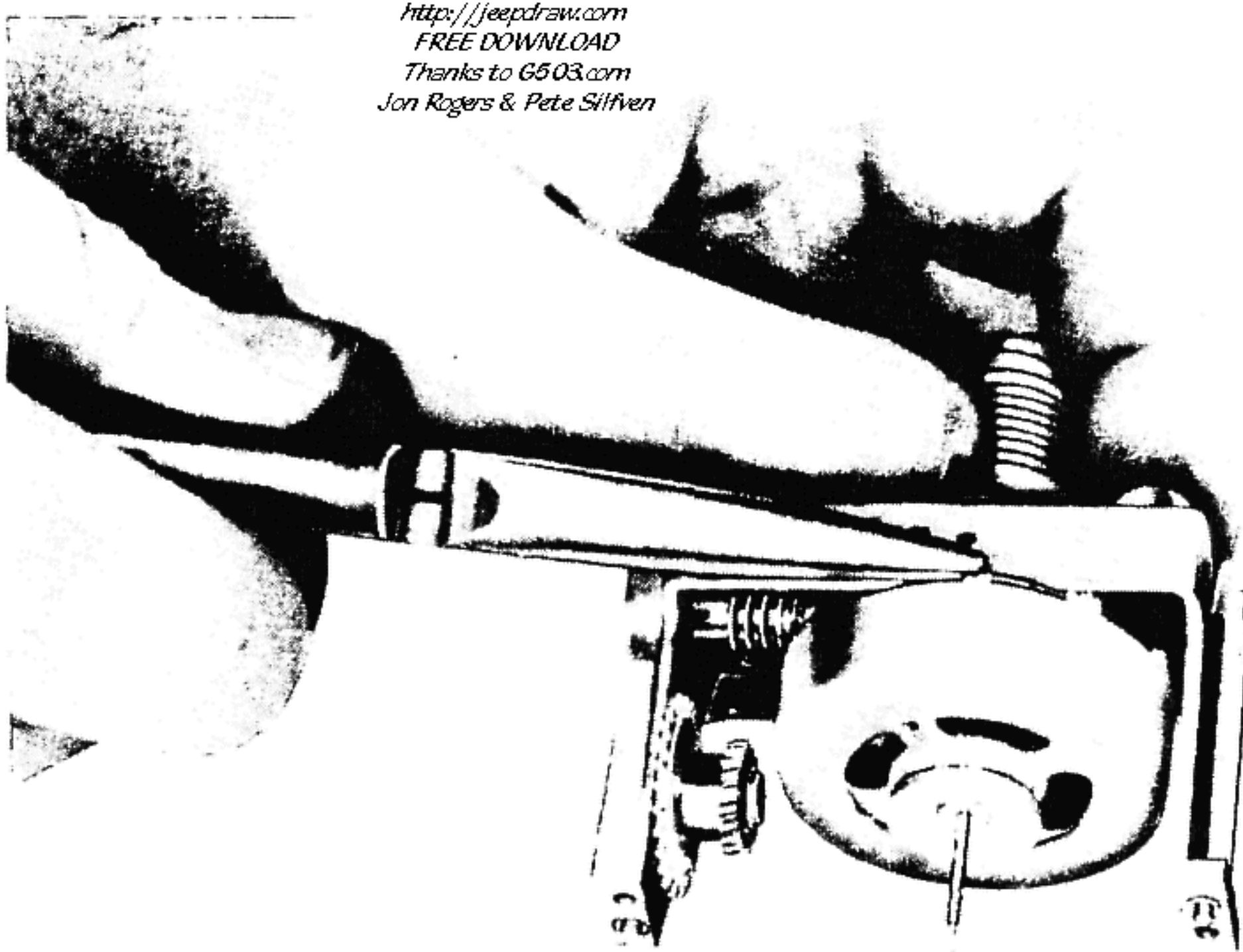

RA PD 318925

**Figure 40—Removing Field Plate and Speed Cup**

**l. Remove Magnet** (fig. 42). Do not remove magnet unless magnet, shaft or frame must be replaced. If magnet is not in good condition, or if side play exceeds 0.003 inch, install puller on frame and screw plunger against magnet shaft until shaft is free of collar (fig. 42). Remove collar and file burs from shaft. **CAUTION:** *Do not drive magnet shaft through bearing, but first file all burs smooth so that shaft will pass through bearing without damaging it. Be careful not to lose thrust washers on either end of magnet shaft.*

**m. Remove Intermediate Gear Assembly.** Remove idler assembly by grinding or filing off staked portion on outside of main frame, then drive out stud with punch and hammer.

**n. Remove Oilhole Covers.** Place tang of screwdriver into hole in cover, set on an angle (not under the flange) and force downward on handle, lifting cover on one side until it is free from main frame.

**21. CLEANING, INSPECTION, AND REPAIR OF PARTS.**

**a.** The procedure for cleaning, inspection, and repair is the same as for SPA-series. Refer to paragraph 12.

## SPK, SPP, AND SPR SERIES

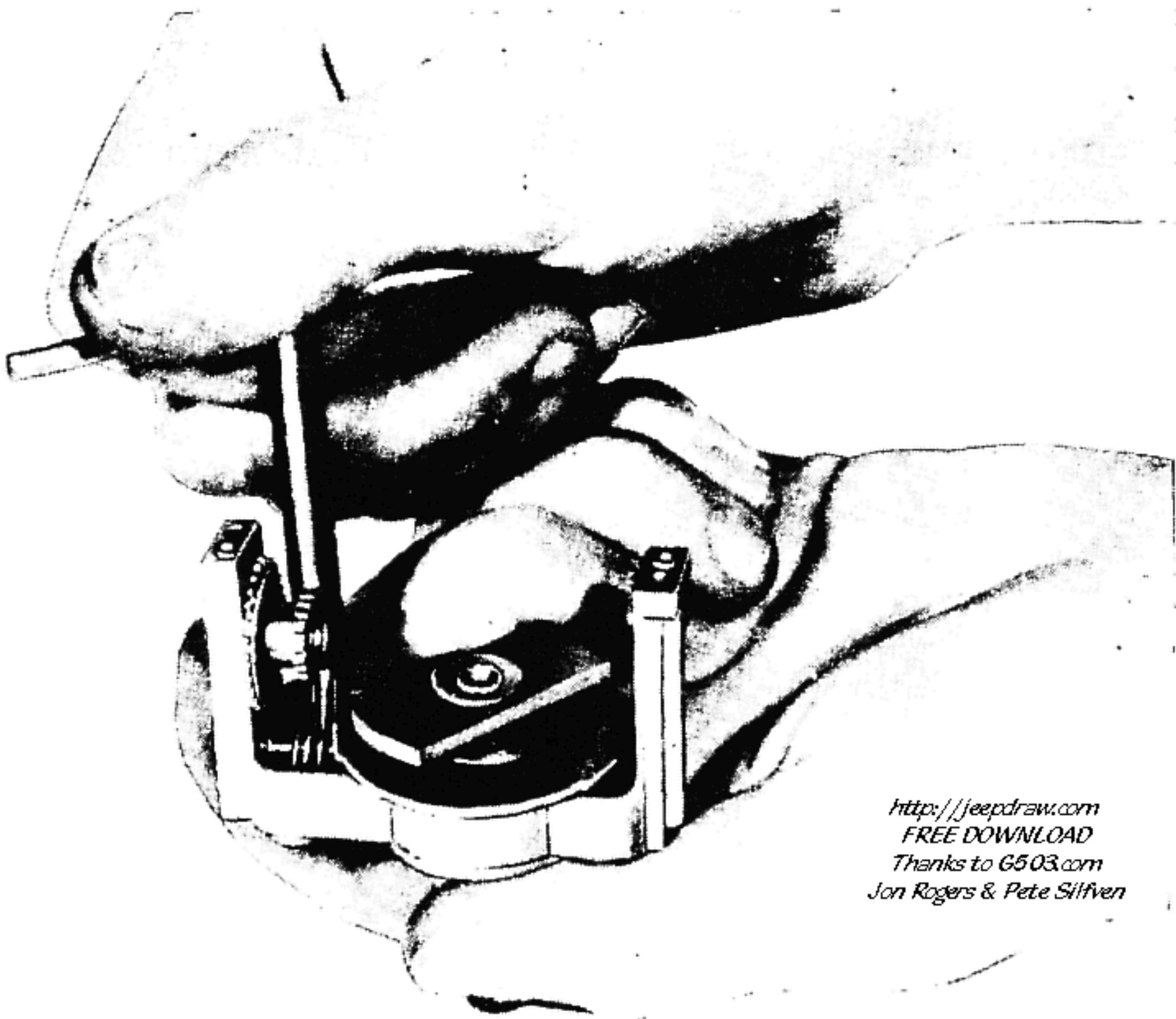

*http://jeepdraw.com  
FREE DOWNLOAD  
Thanks to G503.com  
Jon Rogers & Pete Silfven*

RA PD 318926

**Figure 41—Removing Second Gear, Using Extractor (ST-263-34)**

## 22. ASSEMBLY.

a. **Install Magnet.** Grease (using ST-263-36) magnet shaft its full length and spread grease over entire bearing surface. Place thrust washer on magnet shaft with tang toward main frame, so it will engage with one frame web to prevent it from turning. Insert magnet shaft in main frame and place thrust washer on end of shaft. Place collar on end of shaft and press into place (fig. 31). Inspect to make sure there is enough metal left on end of shaft for proper flaring. When a new shaft is used it may be necessary to use more than one thrust washer under the collar. Flare end of the shaft with tool (T-170666) (fig. 32). Adjust magnet shaft end play to 0.002 inch by flaring shaft so it is tight. Insert feeler gage between shaft collar and frame, and loosen shaft slightly with magnet removing tool until the gage fits easily. Use a combination of the flaring tool and magnet removing tool (fig. 42) to adjust end play to a gage fit of 0.002 inch. Move feeler gage all around the shaft to make sure there are no tight spots. The magnet must turn freely after adjustment has been made.



**ORDNANCE MAINTENANCE  
SPEEDOMETERS, TACHOMETERS, AND RECORDERS**

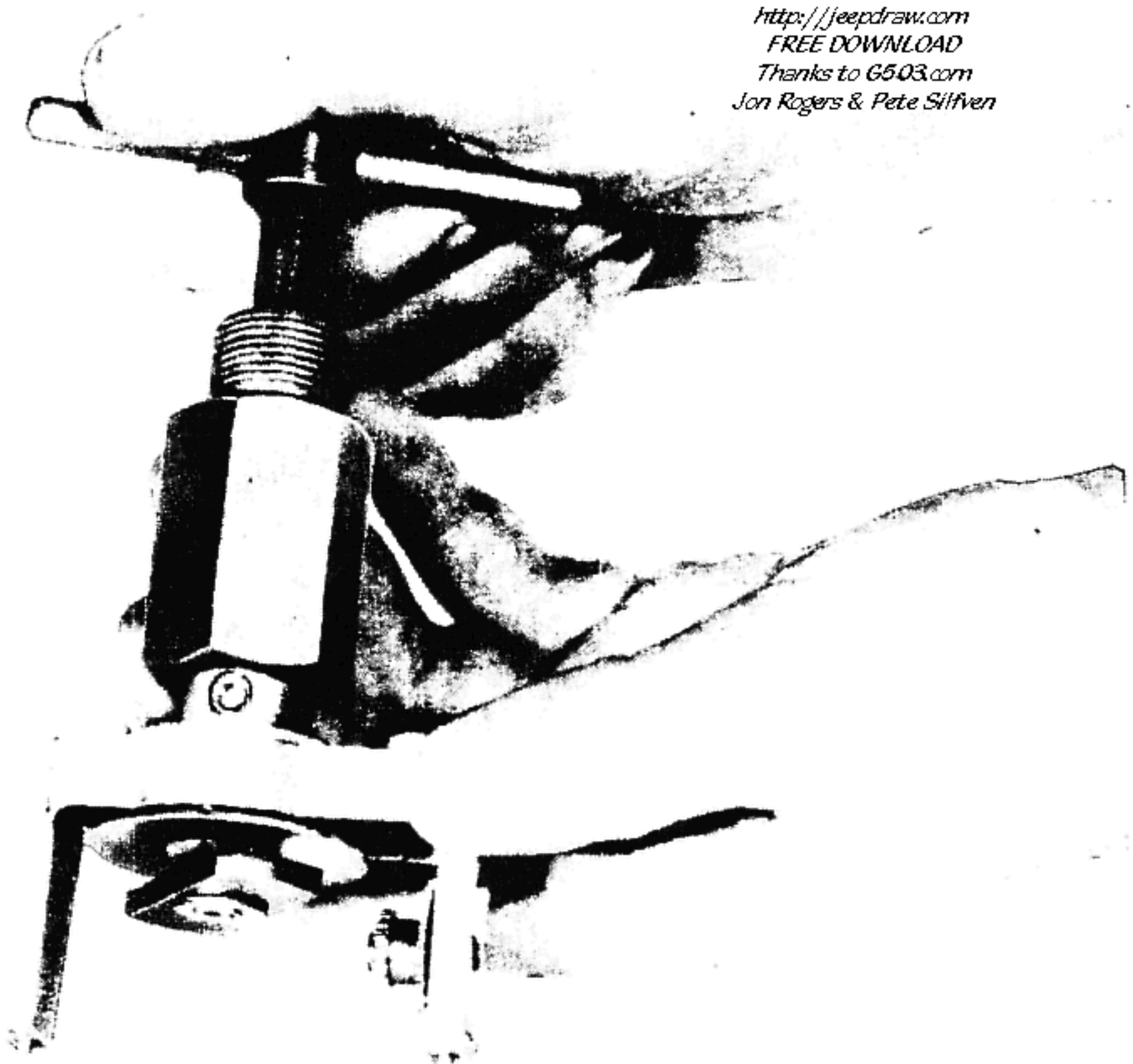

*http://jeepdraw.com  
FREE DOWNLOAD  
Thanks to G503.com  
Jon Rogers & Pete Silven*

RA PD 318927

**Figure 42—Removing Magnet Shaft Collar, Using Dismantling Wrench (T-170654)**

**b. Install Second Gear.** Grease both bearing surfaces and gear surface with No. 00 Grease, O.D. Place thrust washer on inner end of shaft and insert in main frame. Install outer bearing, beveled side in, and seat bearing in proper position with hammer and drift. Check end play of second gear and install thrust washers, if necessary, to get 0.005- to 0.010-inch end play. Stake frame over bushing at three equally spaced places around bushing (fig. 43).

**c. Install Speed Cup and Field Plate.** Clean the rear jewel in top of magnet. Clean speed cup staff. Put one drop of watch and clock oil on lower end of speed cup staff. Place speed cup in position over magnet, making sure lower end of staff enters jewel in top of magnet shaft. Place field plate over speed cup. Bend edges of field plate over with pliers. Make sure assembly runs true after crimping.

**d. Install Third Gear.** Grease bearing surfaces and gear surface. Place washer on lower end of shaft and install gear in frame.

**e. Install Front Jewel Bracket, Hair Spring and Odometer** (par. 18 f, g, h, and i).

## SPK, SPP, AND SPR SERIES



*http://jeepdraw.com  
FREE DOWNLOAD  
Thanks to G503.com  
Jon Rogers & Pete Silfven*

RA PD 318928

**Figure 43—Staking Second Gear Bushing, Using Installer (ST-263-35)**

- f. **Install Trip Odometer.** Proceed as with total odometer and then install reset bracket on main frame.
- g. **Install Dial.** Fasten in place with dial screws, taking care not to mar dial.
- h. **Install Pointer.** Bend pointer stop arm slightly back of zero position, hold speedometer in same position as it will be when installed on the vehicle, float pointer exactly on zero and tap pointer in place on staff.
- i. **Calibrate.** Refer to paragraph 14.
- j. **Install Case.** (Do not install until after calibration.) Install felt washer on reset stem (SPK-type only). Place dust washer over shank of main frame and install case screws. Install reset knob or cable.
- k. **Install Bezel and Glass.** (Do not install until after calibration.) Before installing glass or bezel make sure dial and glass are clean. Install glass and bezel, using special tool (T-178730) (figs. 74 and 75).

**ORDNANCE MAINTENANCE  
SPEEDOMETERS, TACHOMETERS, AND RECORDERS****CHAPTER 5**

*http://jeepdraw.com  
FREE DOWNLOAD  
Thanks to G503.com  
Jon Rogers & Pete Silfven*

**KING-SEELEY SPEEDOMETERS****23. DESCRIPTION.**

a. King-Seeley speedometers employ a horseshoe-type magnet, and the field plate is permanently assembled as part of the main frame. This make of instrument can thus be readily identified (internally) (fig. 44). For complete description, operation, and test procedure refer to paragraphs 2 and 4.

**24. DISASSEMBLY.**

a. **Remove Bezel and Case.** Pry bezel loose (with screwdriver) at two points about one inch apart. Use cutting pliers and tear out this section of bezel (fig. 51). Then pull bezel off (fig. 52) and remove gaskets, glass, and glass retainer. Remove reset knob screw, reset knob, reset spring and washer. (If knob is tight, hold both reset shaft and reset knob with small pliers and turn knob off.) (On speedometers with flexible reset shaft, remove the reset knob, panel nut, and threaded ferrule from the flexible conduit before removing case. The ferrule is removed by holding the conduit firmly with pliers while unscrewing the ferrule with pliers.) Remove three case screws, backing plate and gasket, and lift mechanism out of case.

b. **Remove Pointer and Dial.** Grasp pointer hub with thumb and forefinger and twist in a counterclockwise direction (against stop) while pulling gently but firmly until it comes off (fig. 78). Remove two dial retaining screws and lock washers, and lift off dial.

c. **Remove Odometer Assemblies.** Pull off outer bronze trip odometer thrust washer with long-nosed pliers. Remove odometer retaining wire, if used. Slip trip odometer, spring, and drive gear out of frame. The reset shaft (stiff type) may now be lifted out of frame. (Flexible reset shaft assemblies are not detached from frame.) Pull off outer bronze total odometer thrust washer. Slip total odometer and drive gear out of frame.

d. **Remove Hair Spring.** Remove hair spring pin by placing one jaw of long-nosed pliers against small end of pin, and the other jaw against end of hair spring regulator and squeezing pin out. Disengage hair spring from regulator with tweezers. Carefully remove hair spring from staff with special puller (T-66296) (fig. 46).

e. **Remove Front Jewel Bracket, Speed Cup, and Third Gear.** Remove front jewel bracket by taking out two screws and lock washers. Speed cup and third gear may now be lifted out. **CAUTION:** *Do not lose tiny speed cup staff thrust washer. It will be either on the staff, or inside the front jewel.* Remove front jewel lock nut, lift off hair spring regulator, and unscrew upper jewel from bracket (fig. 45).

f. **Remove Second Gear.** Remove second gear bracket by taking out screw, and pull out second gear.

**KING-SEELEY SPEEDOMETERS**

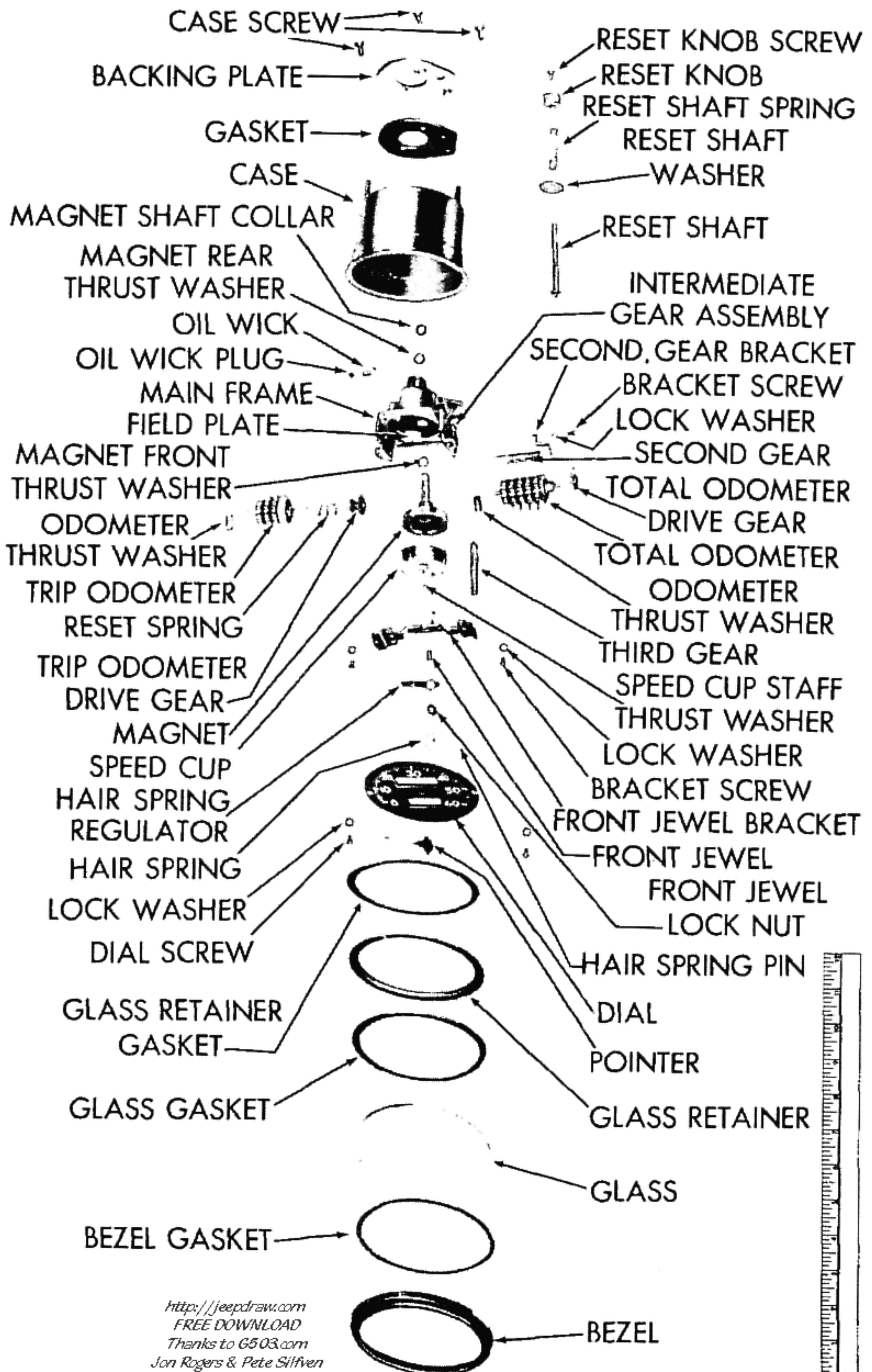

RA PD 318929

**Figure 44—King-Seeley Speedometer, Disassembled**

## ORDNANCE MAINTENANCE SPEEDOMETERS, TACHOMETERS, AND RECORDERS

g. **Remove Magnet (Including First Gear).** Assemble body of magnet dismantling wrench (T-170654) to threaded neck of frame, backing off handle so that wrench body will tighten down snugly to frame. Then turn wrench handle clockwise (fig. 47) until collar is pressed off the magnet shaft. Remove dismantling wrench, magnet shaft collar and rear thrust washer, but do not pull magnet out of frame at this time, as flared end of magnet shaft will score the frame bearing surface. Using fixture (T-170666 with Det 6) (fig. 61) tighten down handle to smooth out flare in magnet shaft. **CAUTION:** Care must be taken to make sure that fixture does not come in con-

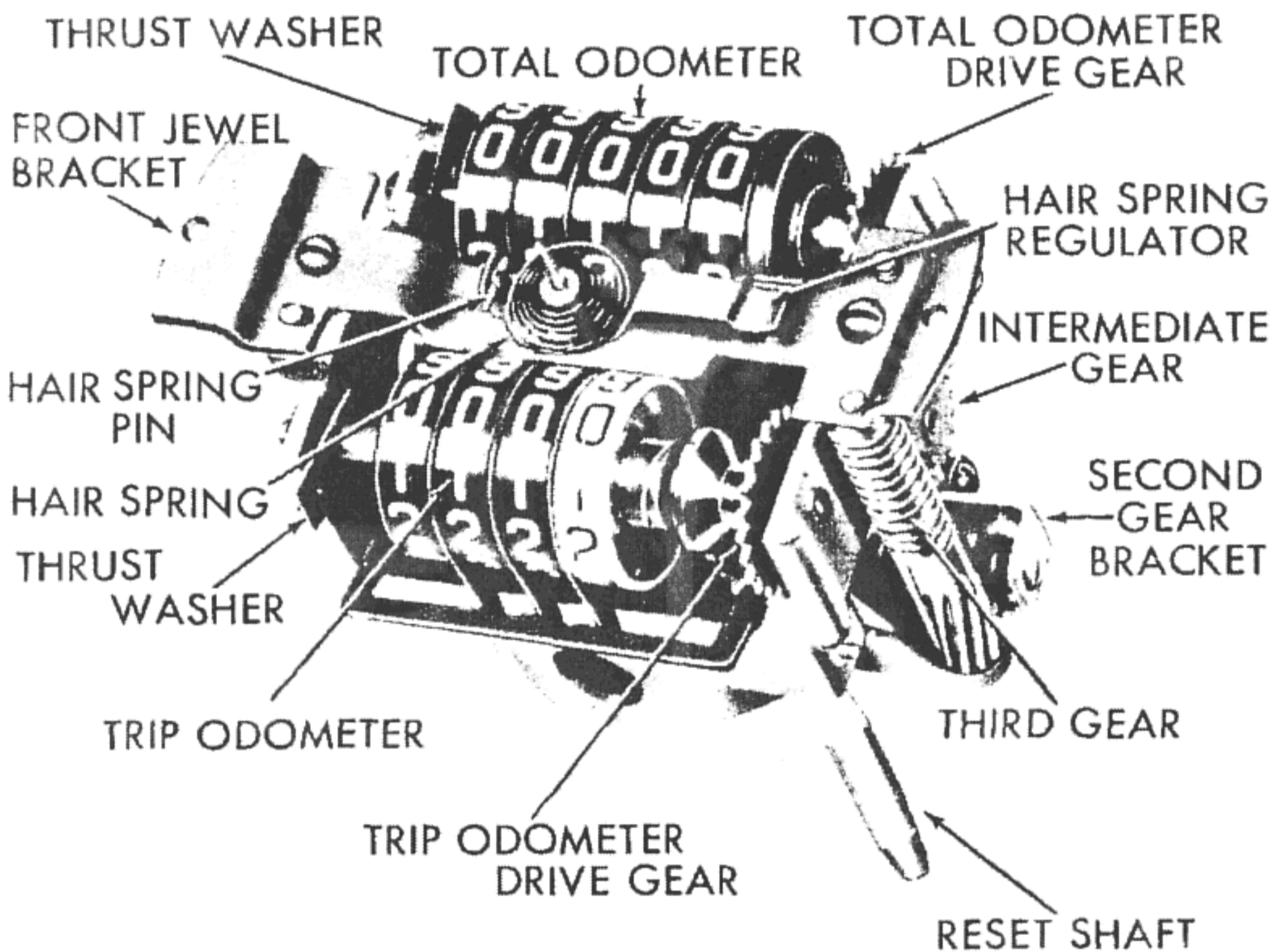

RA PD 318930

**Figure 45—Speedometer Mechanism (Dial Removed)**

tact with steel portion of magnet, causing it to be weakened. After smoothing out flare use safety-edge file (T-170757) to remove any remaining flare or burs from end of magnet shaft. If these operations are done carefully the magnet can be pulled out of the frame with the fingers without scoring.

h. **Remove Oil Wick.** Insert punch in plug and tap lightly. This will push wick and plug through into magnet shaft bearing hole in frame.

## KING-SEELEY SPEEDOMETERS

### 25. CLEANING, INSPECTION, AND REPAIR OF PARTS.

a. **General Cleaning.** Thoroughly clean hair spring, speed cup, second gear, third gear, odometer drive gears, reset shaft, frame, brackets, springs, screws, and metal washers with brush and dry-cleaning solvent. Make sure to remove every trace of grease, dirt,

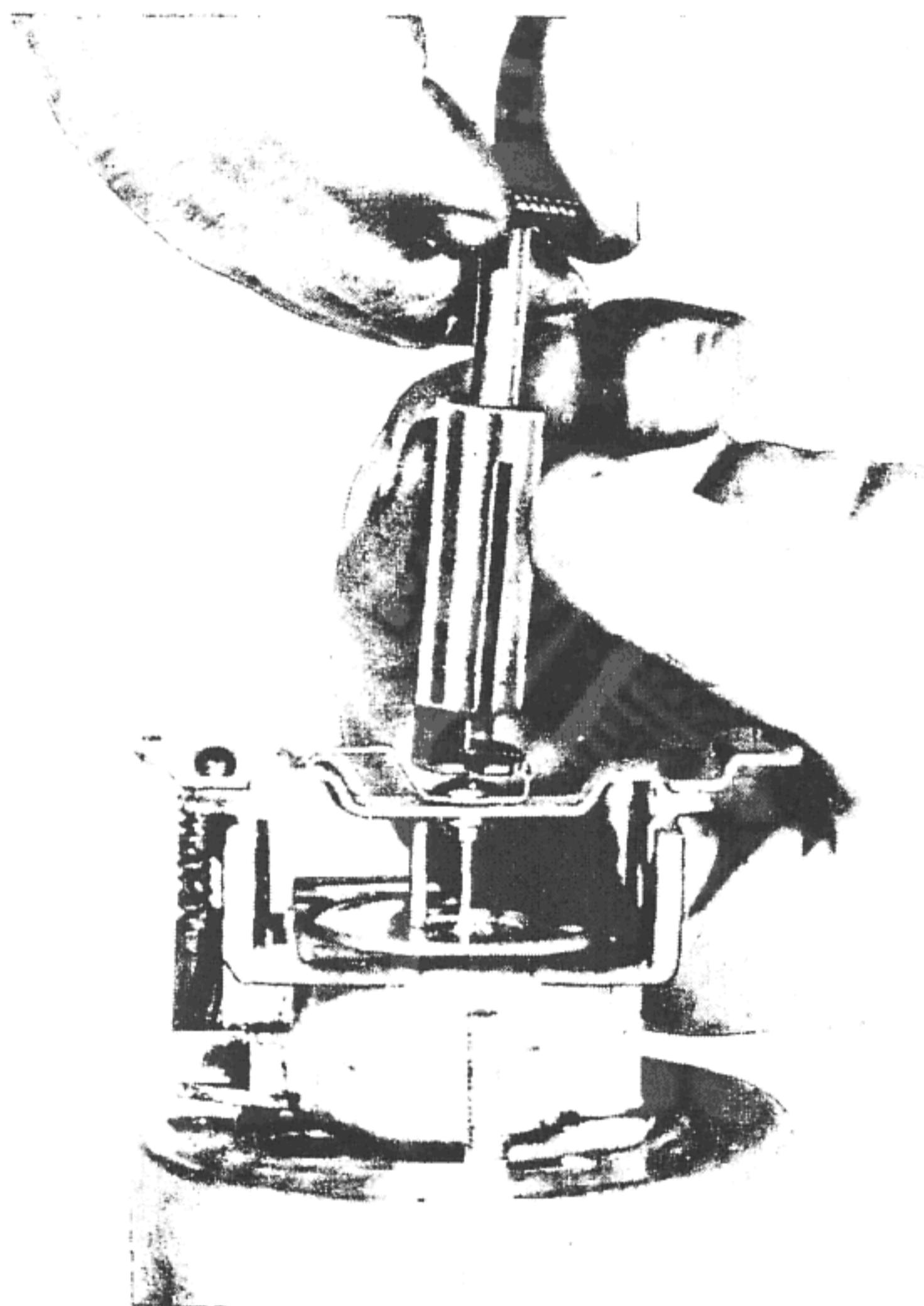

RA PD 318931

**Figure 46—Removing Hair Spring, Using Puller (T-66296)**

and lint so that any defects will be easily found. Carefully dry parts with compressed air. Wipe other parts clean with a rag.

b. **Main Frame.** Inspect magnet shaft bearing hole. If scored or worn, replace with new frame assembly. To test, insert the end of a new magnet shaft into bearing hole about  $\frac{1}{2}$  inch. Test clearance, particularly at inner end of bearing. Wear in excess of 0.002 inch requires frame replacement. If the second gear bushing, the field plate, or the intermediate gear are worn or missing, replace the entire frame assembly.

## ORDNANCE MAINTENANCE SPEEDOMETERS, TACHOMETERS, AND RECORDERS

- c. **Magnet.** Inspect first gear. If visibly worn or nicked, replace magnet (including first gear).
- d. **Second and Third Gears.** If gear teeth are worn or nicked replace.
- e. **Speed Cup and Staff.** Inspect speed cup. If cup or staff is bent, replace.
- f. **Hair Spring.** Inspect hair spring. If kinked or bent, replace.

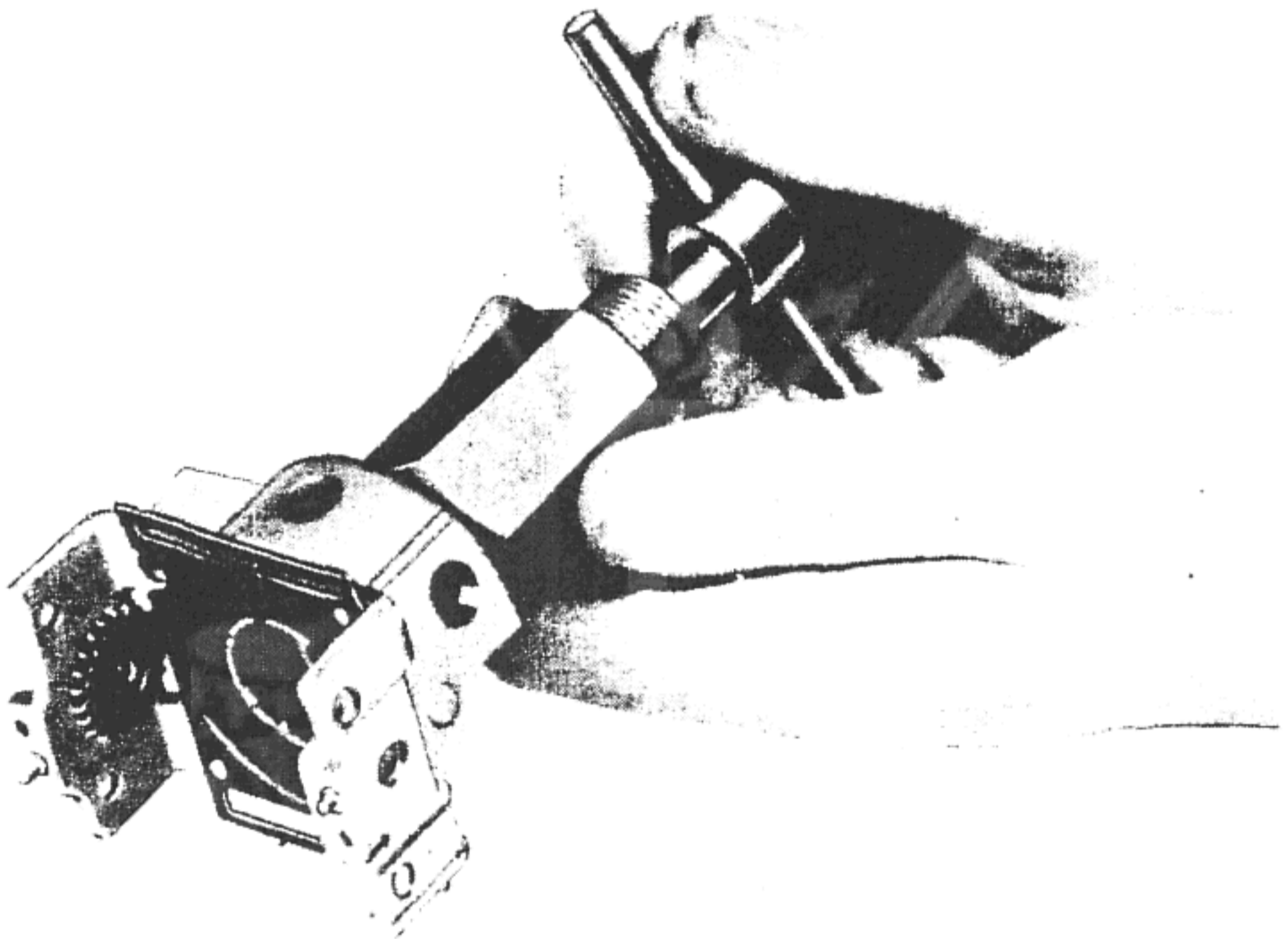

RA PD 318932

**Figure 47—Removing Magnet Shaft Collar, Using Dismantling Wrench (T-170654)**

g. **Odometers.** Clean surface of odometer rolls, if necessary, by rubbing lightly with clean, soft chamois. If odometer is defective, replace complete odometer.

h. **Front Jewel Bracket and Front Jewel.** Inspect bracket. If bent or stop pin is loose, replace. Inspect jewel. If worn out-of-round, replace.

### 26. ASSEMBLY.

a. **Install Magnet (Including First Gear).** Place magnet front thrust washer (two ears) on magnet shaft with turned ear pointing

**KING-SEELEY SPEEDOMETERS**

away from magnet. Apply a light coat of No. 00 Grease, O.D., to magnet shaft and first gear (not to magnet), and insert magnet in frame. Place rear (round) thrust washer and magnet shaft collar over end of magnet shaft. Using magnet assembly fixture (T-170666 with Det 1), tighten down (fig. 65) until collar is pressed all the way onto shaft. **CAUTION:** *Care must be taken when using fixture to make sure that it does not come in contact with steel portion of magnet, causing it to be weakened.* If a new magnet is used, be sure to remove keepers. Using fixture (T-170666 with Det 6), flare end

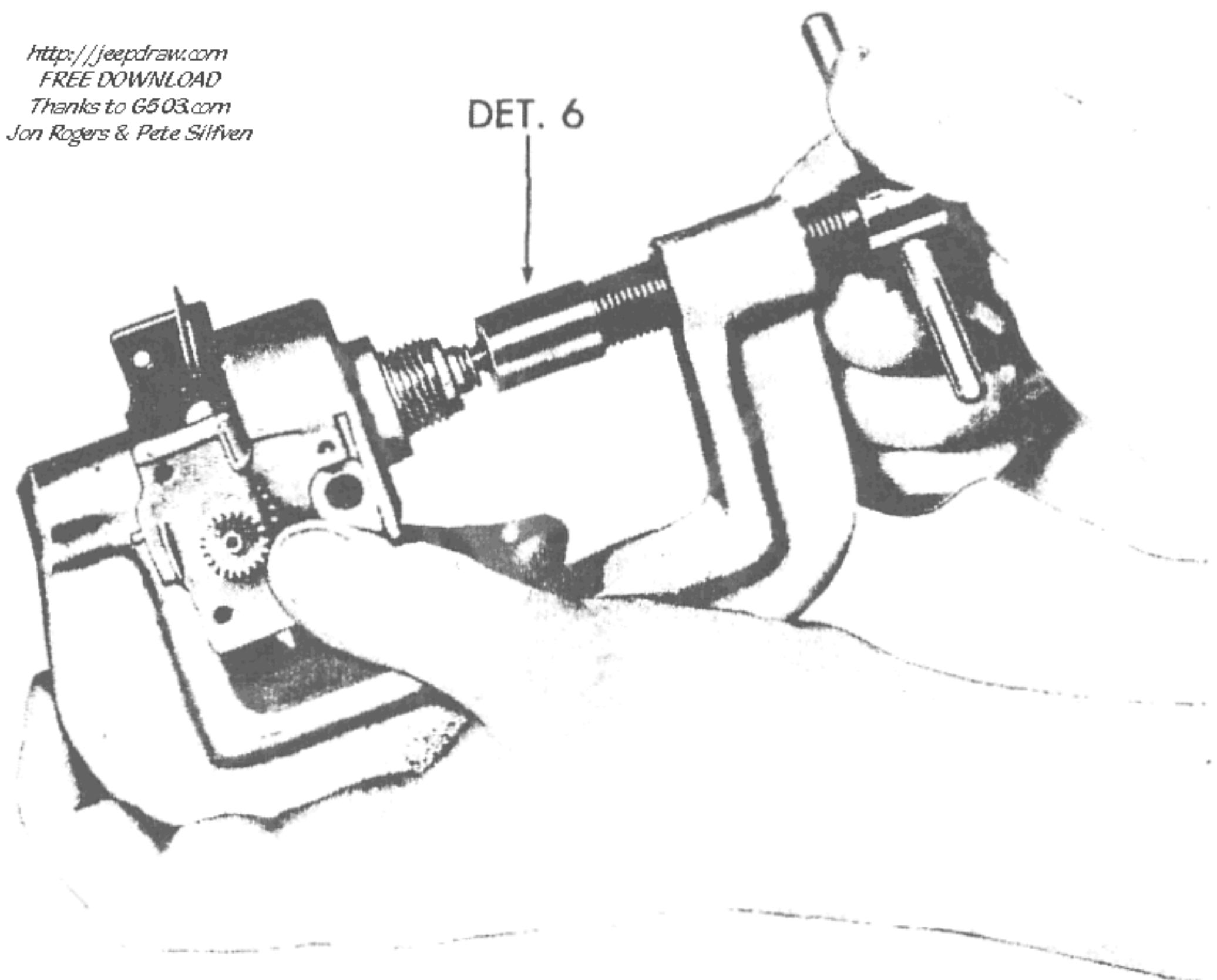

RA PD 318933

**Figure 48—Flaring Magnet Shaft, Using Fixture (T-170666 with Det 6)**

of magnet shaft (fig. 48). Take up all end play. To establish proper end play, use magnet dismantling wrench (T-170654) (fig. 47), and start shaft out by tightening down wrench handle  $\frac{1}{2}$  turn, or less. The correct end play (0.005 inch to 0.007 inch) can be gaged by inserting a feeler between the collar and rear thrust washer.

**b. Install Oil Wick and Plug.** Saturate oil wick in watch or clock oil, squeeze out excess oil, and insert wick in hole in frame. Push in oil wick plug (hollow end out) until flush with hub of frame. Do not push in too far.

**c. Install Second Gear.** Apply a very light coat of No. 00 Grease, O.D., to second gear teeth and insert in frame, turning



## ORDNANCE MAINTENANCE SPEEDOMETERS, TACHOMETERS, AND RECORDERS

magnet slightly to mesh gears. Assemble bracket, lock washer and screw. Second gear end play should be 0.008 inch to 0.012 inch. Adjust, if necessary, by bending second gear bracket.

d. **Install Third Gear, Speed Cup, and Front Jewel Bracket.** Screw front jewel into bracket. Run the front jewel through the bracket at least twice to make sure it screws freely. Place hair spring regulator in position, and screw front jewel nut loosely on front jewel. For a good preliminary setting the head of the front jewel should protrude about two threads above the lock nut. Place speed

*http://jeepdraw.com  
FREE DOWNLOAD  
Thanks to G503.com  
Jon Rogers & Pete Silfven*

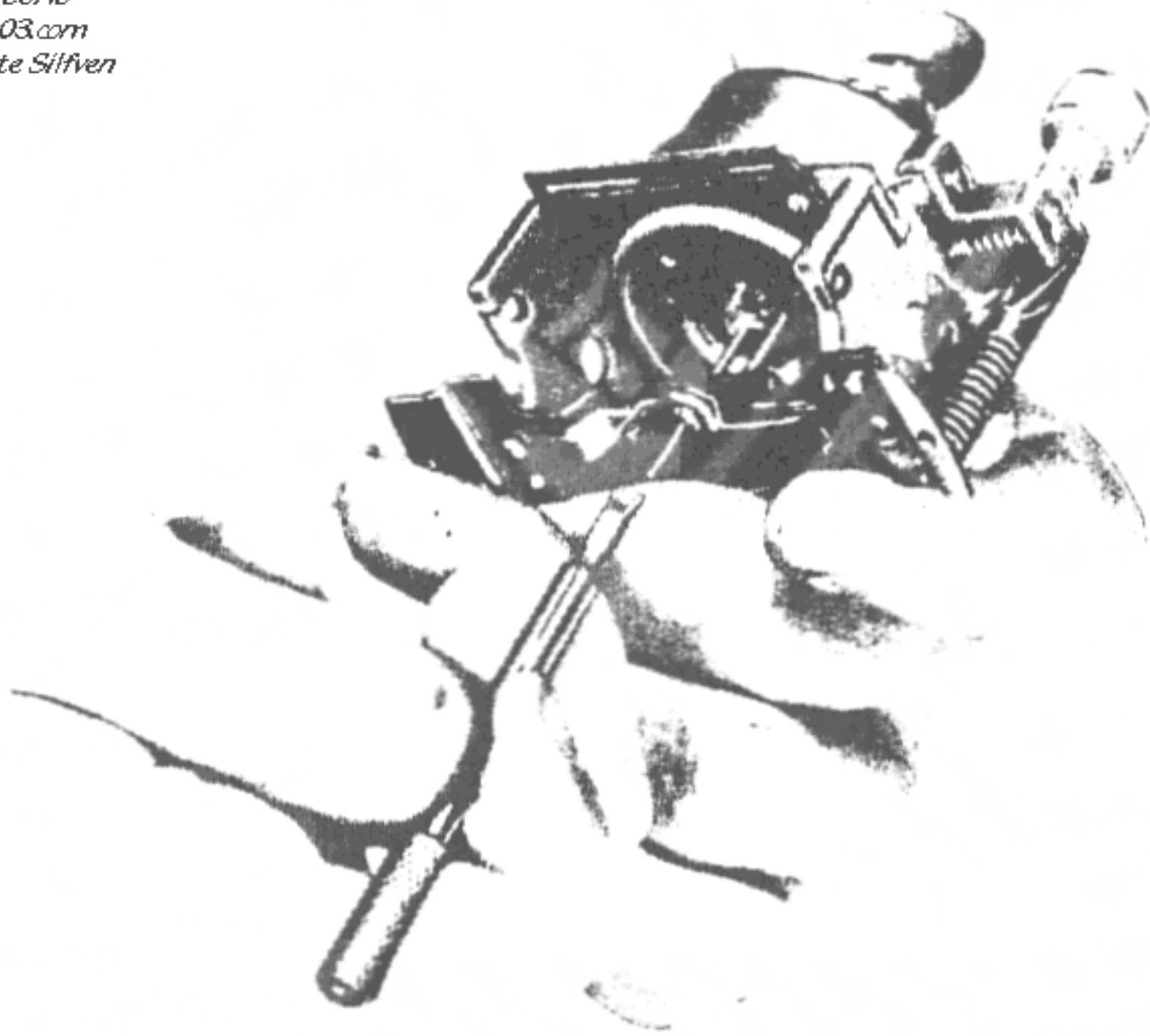

RA PD 318934

**Figure 49—Applying Thumb Pressure on Magnet Shaft While  
Adjusting Front Jewel with Special Tool (T-178705)**

cup over magnet, taking care that staff locates properly in the magnet bearing. Place small bakelite thrust washer over end of staff. Apply light coat of No. 00 Grease, O.D., to teeth of third gear, and place gear in position, properly meshing with second gear and intermediate gear. Assemble front jewel bracket to frame, being careful not to damage front jewel when inserting speed cup staff. Fasten with two screws and lock washers. Check to see that third gear has slight end play (0.002 inch to 0.010 inch). (A bent bracket sometimes makes this part assemble too tightly.) With magnet shaft held up from the bottom with the thumb (to take out all end play), turn

*http://jeepdraw.com*  
 FREE DOWNLOAD  
 Thanks to G503.com  
 Jon Rogers & Pete Silfven

## KING-SEELEY SPEEDOMETERS

the front jewel down lightly (fig. 49), using adjuster (T-178705), until there is no speed cup staff end play. Then back off the front jewel one-third turn. Test speed cup staff end play; it should be 0.005 inch—0.009 inch. Tighten jewel lock nut. The hair spring regulator must be free to move after lock nut is tightened. **CAUTION:** *In setting speed cup end play, all magnet shaft end play must be removed as described above or damage to the speedometer is likely to occur when replaced on the vehicle.*

**e. Install Hair Spring.** Turn speed cup counterclockwise to the stop, and hold in this position during hair spring assembly. Start hair spring on staff in proper position (so that spiral goes out from the center of the hair spring counterclockwise, and with chamfered side of collet down). Make sure that hair spring, without any tension on it, is in such a position that, when pressed down onto the staff, the outer end of the spring will just slip into the lanced ear in the hair spring regulator, so as not to extend more than  $\frac{1}{8}$  inch or less than  $\frac{1}{16}$  inch through this ear. Carefully push hair spring down on the staff, using female punch (T-29 Det 2) until the coils of the hair spring are level with the lanced ear in the regulator. Insert the end of the hair spring into the lanced ear. Insert hair spring pin and tighten with pliers. **CAUTION:** *The tension of the hair spring should be such that it brings the speed cup just back, against the stop, with the hair spring regulator at the lower edge of the jewel bracket.* This provides full adjustment range. Straighten out the hair spring in flat plane, space coils evenly with no coils touching each other or the regulator, in either the unwound (zero) or completely wound (top) position.

**f. Install Odometer Assemblies.** Insert reset shaft into frame. Place trip odometer reset spring and drive gear on shaft. Insert trip odometer into frame, making sure to place spacer feet in slot. Insert trip odometer thrust washer into shaft inner groove next to frame (inside). Test reset operation. Place total odometer drive gear on end of odometer shaft. Insert total odometer in upper set of holders, placing odometer roll legs in the slotted retainer. Insert total odometer thrust washer in groove on shaft next to frame (inside). Check to insure that slight end play exists in odometer shaft. It is possible that frame ends may be bent together. There are two types of frames—one with odometer shaft holes, the other with slots. The latter requires a wire odometer holding clip. Check for free turning (par. 4 b).

**g. Install Dial and Pointer.** Assemble dial to front jewel bracket with two screws and lock washers. Assemble pointer to staff with fingers. Tighten on by turning counterclockwise until the pointer indicates zero with the speed cup against the stop, pressing slightly downward. Check hair spring tension. If pointer returns too sharply to zero, or too slowly, adjust hair spring with regulator. This tension should result in a float zero setting (no bank) when pointer is released from 7 miles per hour and permitted to drop to zero. **NOTE:**

**ORDNANCE MAINTENANCE  
SPEEDOMETERS, TACHOMETERS, AND RECORDERS**

*The speedometer should now be calibrated before completing assembly (par. 27).*

**h. Install Case, Bezel, etc.** To provide better weatherizing, paint inside of case around the hub hole with cement, type B, joint and thread compound. Place mechanism in case, and assemble gasket and backing plate with screws. Place reset washer (or washers) and spring on reset shaft and attach knob. (On flexible-reset type, if the original reset ferrule has been removed, use a new one. With flexible conduit straight, pull reset shaft out as far as it will come. Slip reset ferrule over conduit with end of threaded section 1 inch from the end of the reset shaft. This brings the end of the ferrule midway between the two shoulders on the reset stem tip. Crimp the ferrule onto the conduit with a blunt chisel and hammer.) Assemble gaskets, retainer, glass, and retainer to case in order shown in figure 44. Roll bezel with special fixture (T-178730) and arbor press (figs. 74 and 75).

**27. CALIBRATION.**

**a.** Place the speedometer on the calibrating machine and hold at the proper operating panel slope (standard Quartermaster's Corps Ordnance—30 degrees). Run master head at 60 miles per hour. The repaired speedometer with a new (or recharged) magnet will over-read considerably. Demagnetize carefully until unit reads about 65 miles per hour (that is, approximately 1/4 inch beyond 60). Use special tool (846294) for demagnetizing (refer to par. 9 e). Then check speed at 10 and 30 miles per hour. The master speedometer service calibration limits are:

10 mph		30 mph		60 mph
+1	.....	+2	.....	+3
-1	.....	-0	.....	-0

The repaired speedometer should read proportionately high at 10 and 30 miles per hour, if hair spring adjustment is correct. If not, move hair spring regulator up until desired proportionate calibration is reached. Then carefully demagnetize further (at 60 miles per hour on master head) until the repaired unit reads within limits. **CAUTION:** *Do this demagnetizing very carefully, as it is extremely difficult to recharge magnets that have been knocked down too far (par. 9 b).* For further instructions refer to chapter 13.

*http://jeepdraw.com  
FREE DOWNLOAD  
Thanks to G503.com  
Jon Rogers & Pete Silfven*

## CHAPTER 6

*http://jeepdraw.com*  
FREE DOWNLOAD  
Thanks to G503.com  
Jon Rogers & Pete Silfven

# STEWART-WARNER SPEEDOMETERS AND TACHOMETERS

### Section I

## SPEEDOMETERS WITH CUP-TYPE MAGNETS

(Types 570, 579, 580, 581, 587, 589, 590, 679)

### 28. DESCRIPTION.

a. This type Stewart-Warner speedometer (fig. 50) can be readily identified (internally) by the cup-type magnet and the shape of the main frame. For complete description, operation and test procedure, refer to paragraphs 2 and 4.

### 29. DISASSEMBLY.

#### a. Remove Bezel and Case.

(1) **CRIMPED BEZEL.** Pry up bezel at crimped points (with screwdriver) and remove bezel, gaskets, retainer, and glass (or glass dial). (Some instruments of this type do not have a bezel or glass.) If necessary, remove reset knob. Remove two case screws at back, and lift out mechanism.

(2) **ROLLED BEZEL.** Pry bezel loose (with screwdriver) at two points about 1 inch apart. Use cutting pliers and tear out this section of bezel (fig. 51). Then pull bezel off (fig. 52), and remove other parts (par. a (1) above).

b. **Remove Pointer and Dial.** The regular-type pointer is removed by grasping pointer hub between thumb and forefinger and twisting gently in counterclockwise direction (against stop), at the same time pulling pointer outward carefully (fig. 78). To remove disk-type pointer, twist counterclockwise to loosen, then insert slot of puller (T-131105) under pointer bushing and pry upward, continuing to twist pointer counterclockwise until it is forced loose from staff (fig. 53). Then remove two dial retaining screws, and lift off dial.

c. **Remove Odometer Assemblies.** There are two methods used in mounting odometers in these types of speedometers:

(1) On speedometers with total odometer above and trip odometer below speed cup staff (fig. 54), pry up end of total odometer retainer and pull total odometer out of frame. To remove trip odometer remove cross bar (one screw), pry up end of retainer, squeeze drive gear against the trip odometer tenth dial and pull trip odometer out of frame. **NOTE:** *Removing trip odometer also releases reset gear, drive gear, and reset spring.*

(2) On speedometers with total and trip odometers in line (fig. 55) remove retaining screw, pry up end of retainer, and pull out odometers.

**ORDNANCE MAINTENANCE  
SPEEDOMETERS, TACHOMETERS, AND RECORDERS**

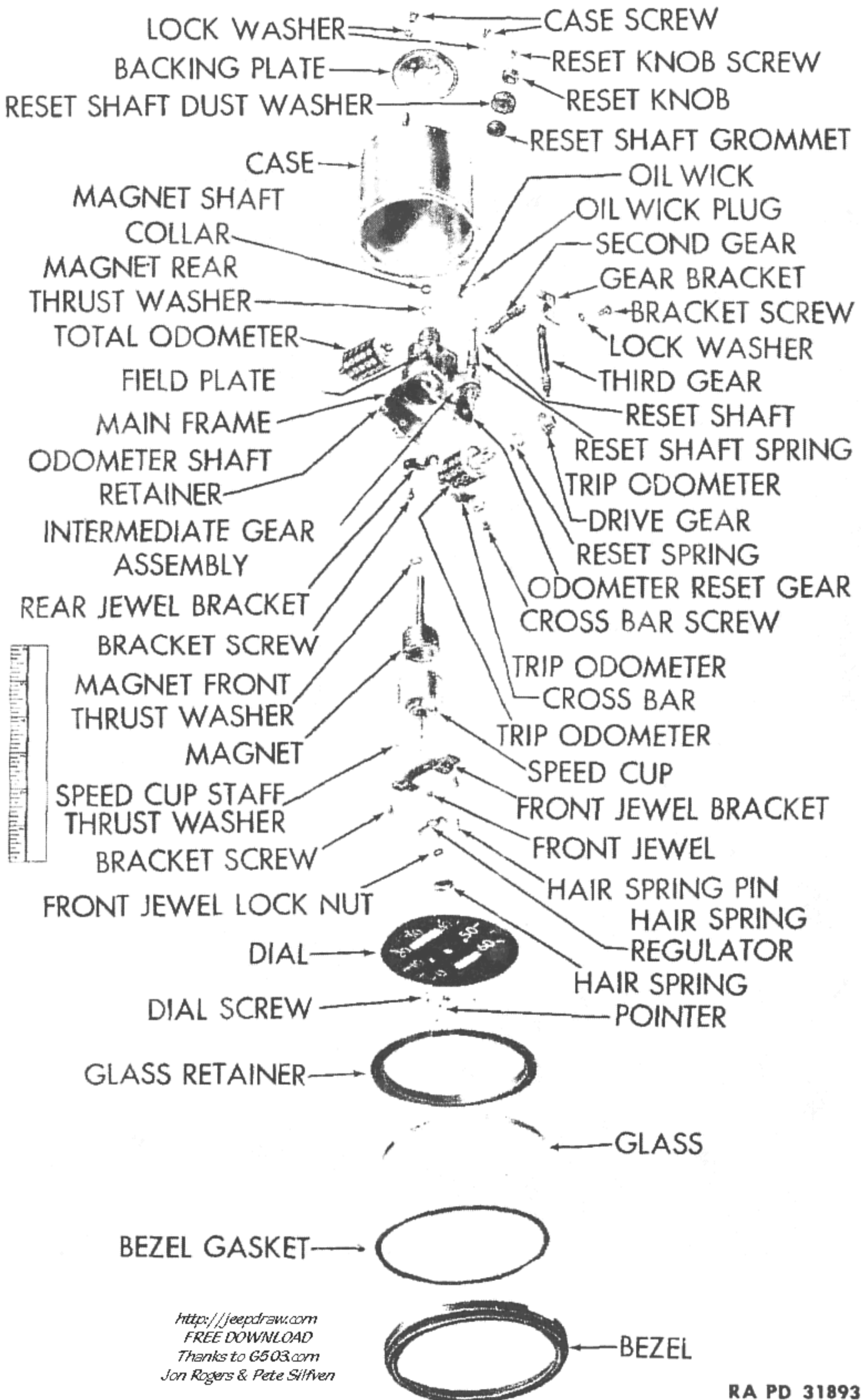

*http://jeepdraw.com  
FREE DOWNLOAD  
Thanks to G503.com  
Jon Rogers & Pete Silfven*

RA PD 318935

**Figure 50—Stewart-Warner Speedometer with Cup-type Magnet Disassembled**

## SPEEDOMETERS WITH CUP-TYPE MAGNETS

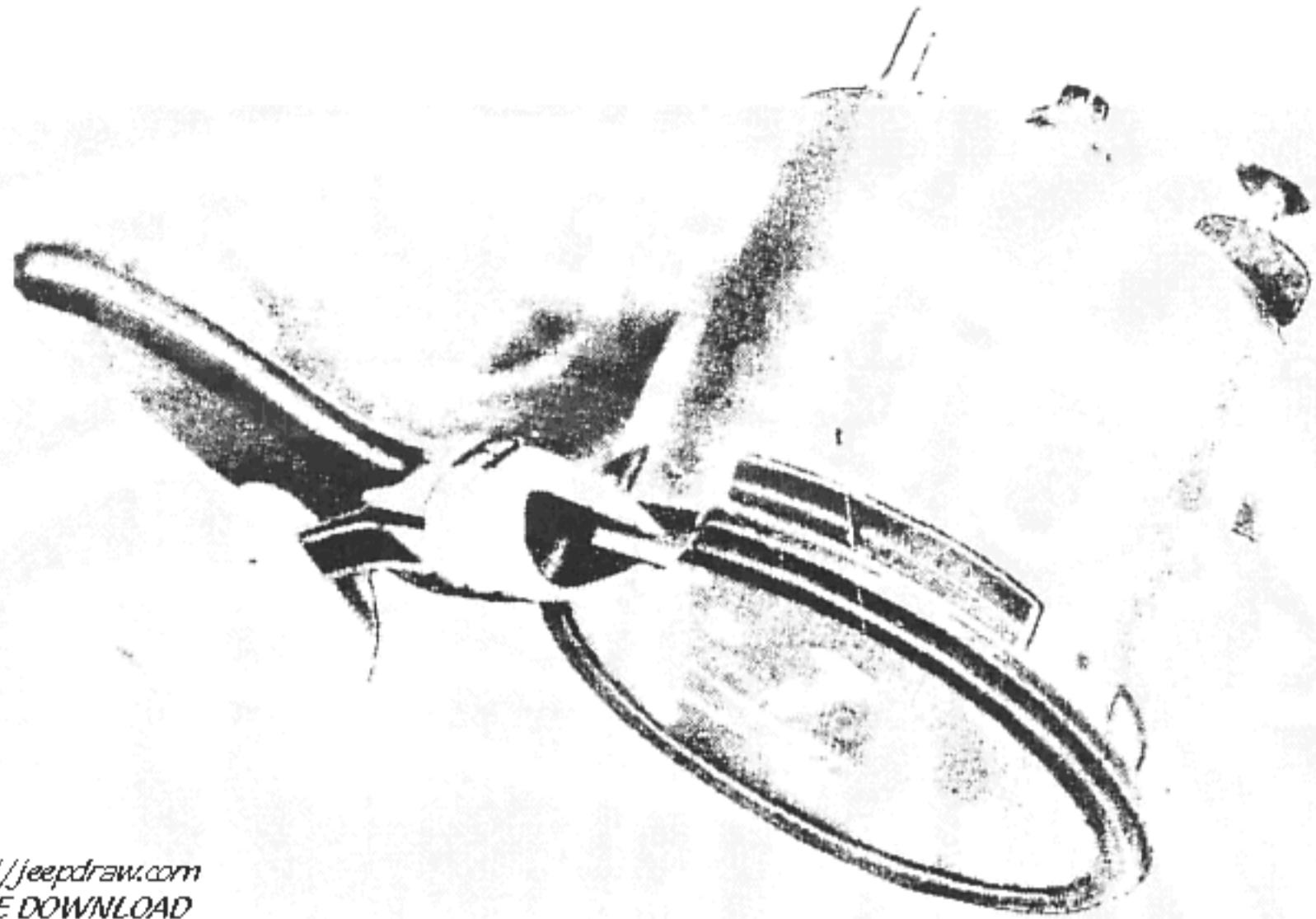

*http://jeepdraw.com*  
 FREE DOWNLOAD  
 Thanks to G503.com  
 Jon Rogers & Pete Silfven

RA PD 318936

**Figure 51—Tearing Out Section of Rolled Bezel**

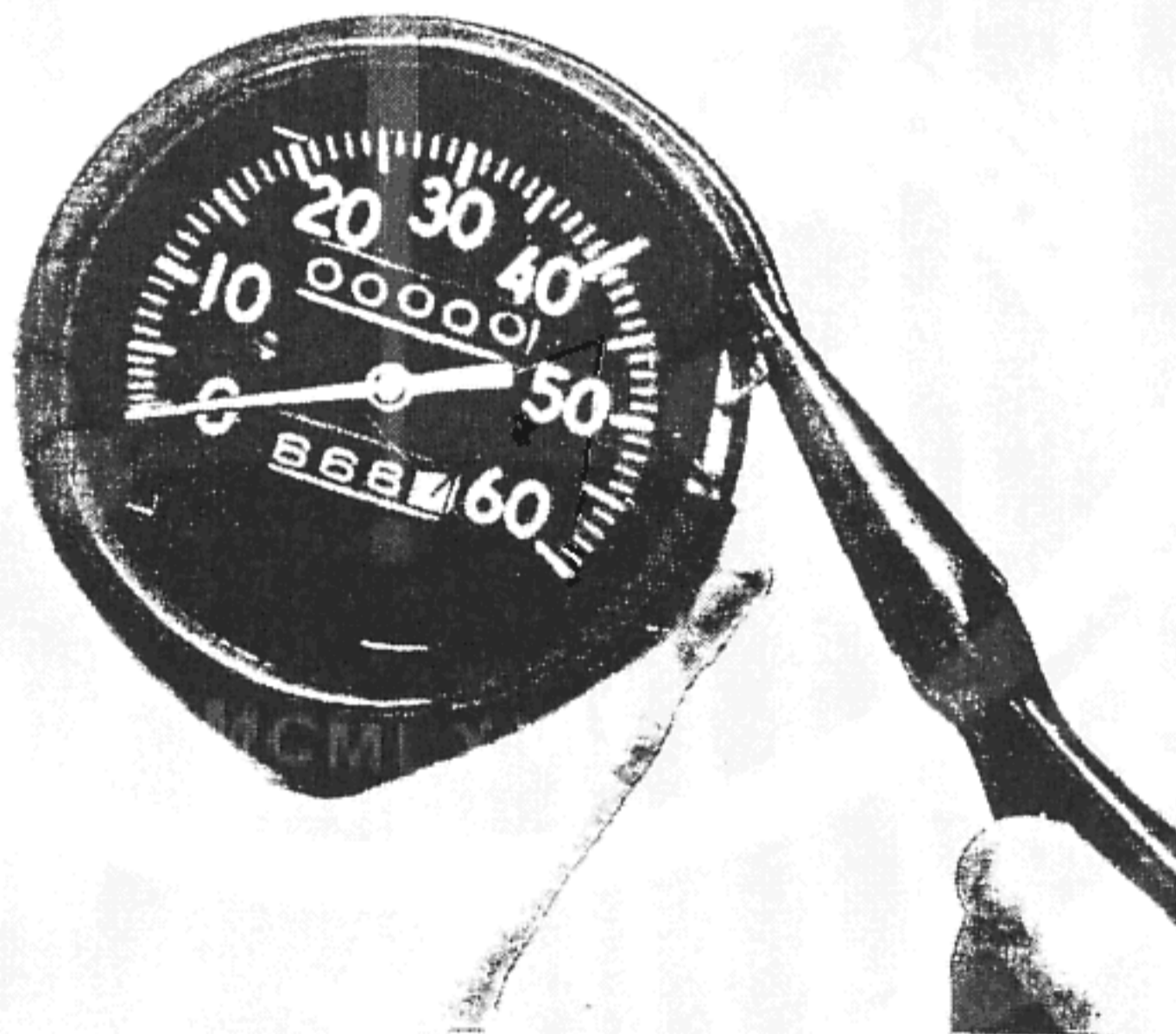

RA PD 318937

**Figure 52—Pulling Off Rolled Bezel**

d. **Remove Jewel Brackets and Speed Cup** (fig. 56). Remove rear jewel bracket screw and lift out bracket. Remove the two front jewel bracket screws and lift out speed cup, front jewel bracket, and hair spring as an assembly.

e. **Remove Hair Spring.** Remove hair spring pin by placing one

**ORDNANCE MAINTENANCE  
SPEEDOMETERS, TACHOMETERS, AND RECORDERS**

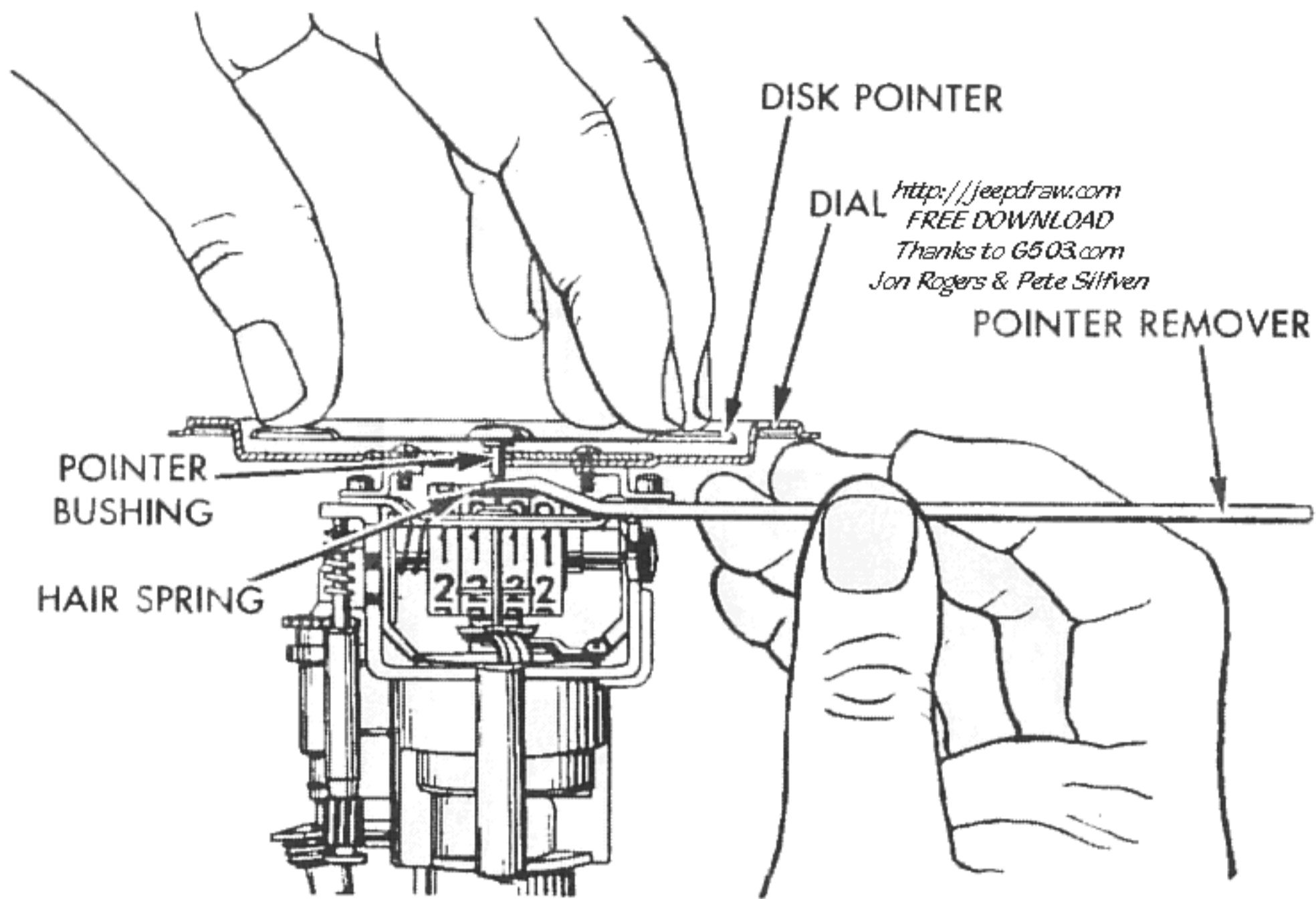

RA PD 318938

**Figure 53—Removing Disk-type Pointer, Using Special Puller (T-131105)**

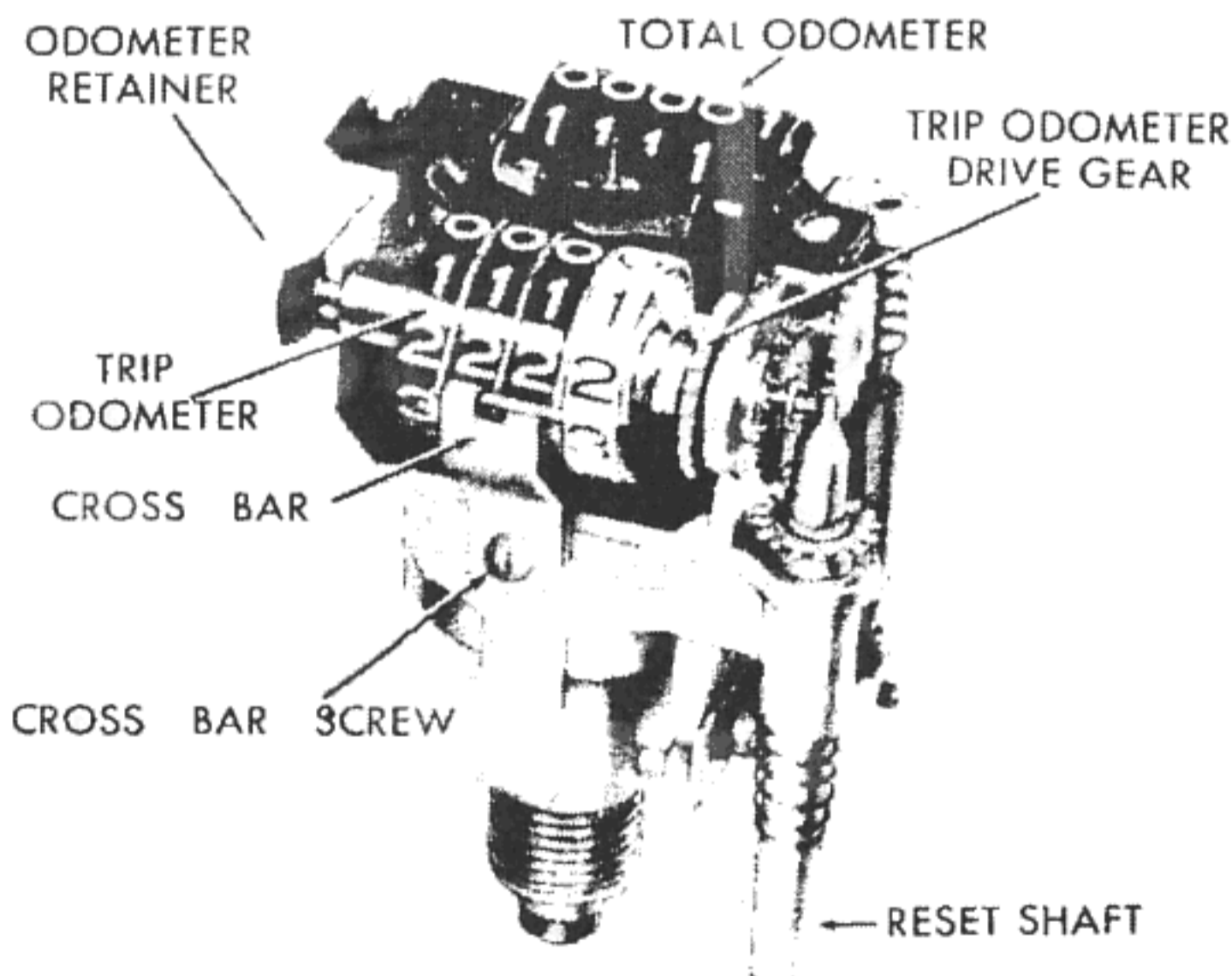

RA PD 318939

**Figure 54—Speedometer Mechanism (Dial Removed)**

jaw of long-nosed pliers against small end of pin and other jaw against end of hair spring regulator and squeezing pin out (fig. 57). Back off thumb screw of hair spring puller (T-66296) and place claw around staff and under center of hair spring. If insufficient clearance under hair spring to admit claw of hair spring puller, use hair spring

**SPEEDOMETERS WITH CUP-TYPE MAGNETS**

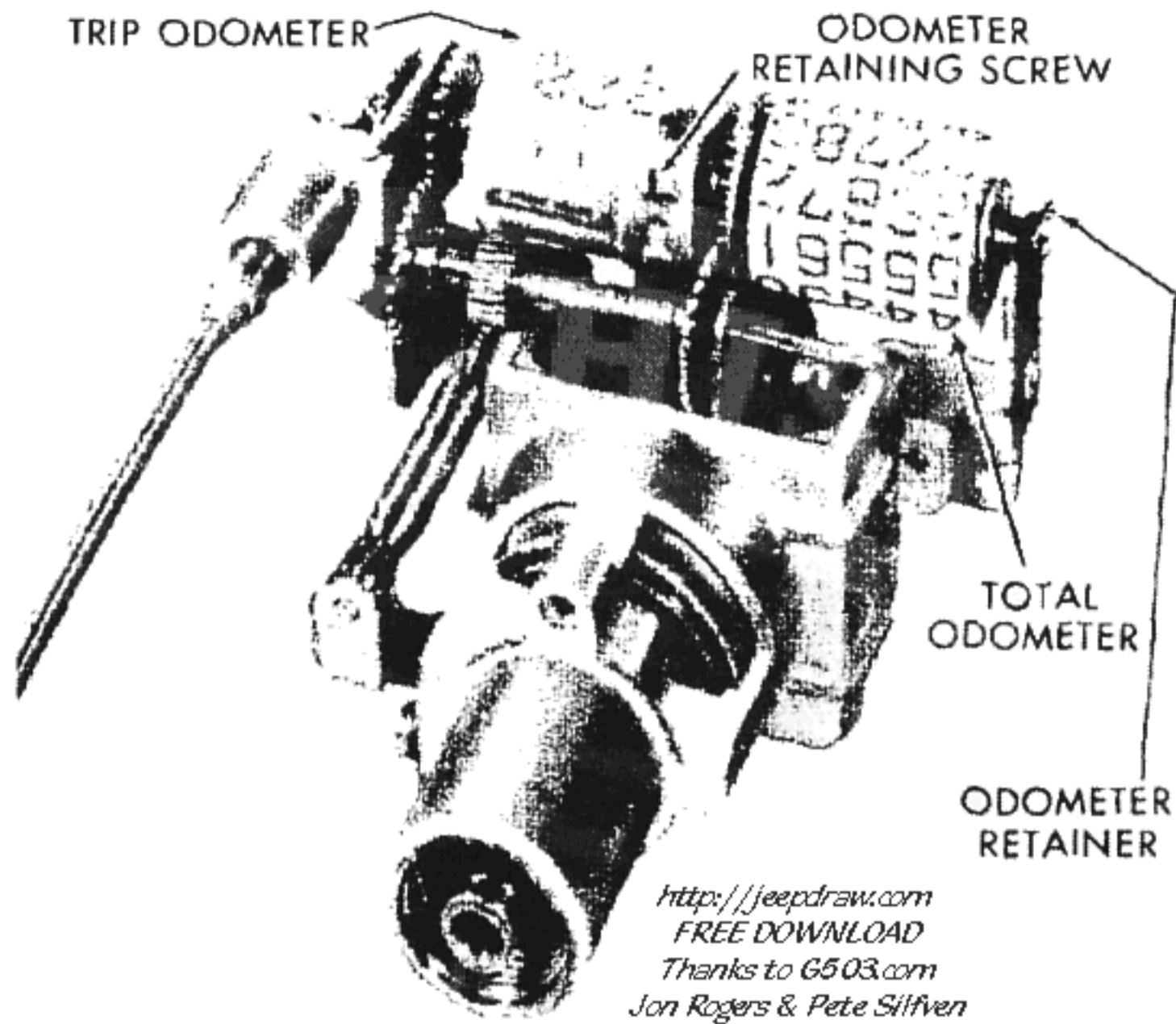

RA PD 318940

**Figure 55—Speedometer Mechanism with Odometers in Line**

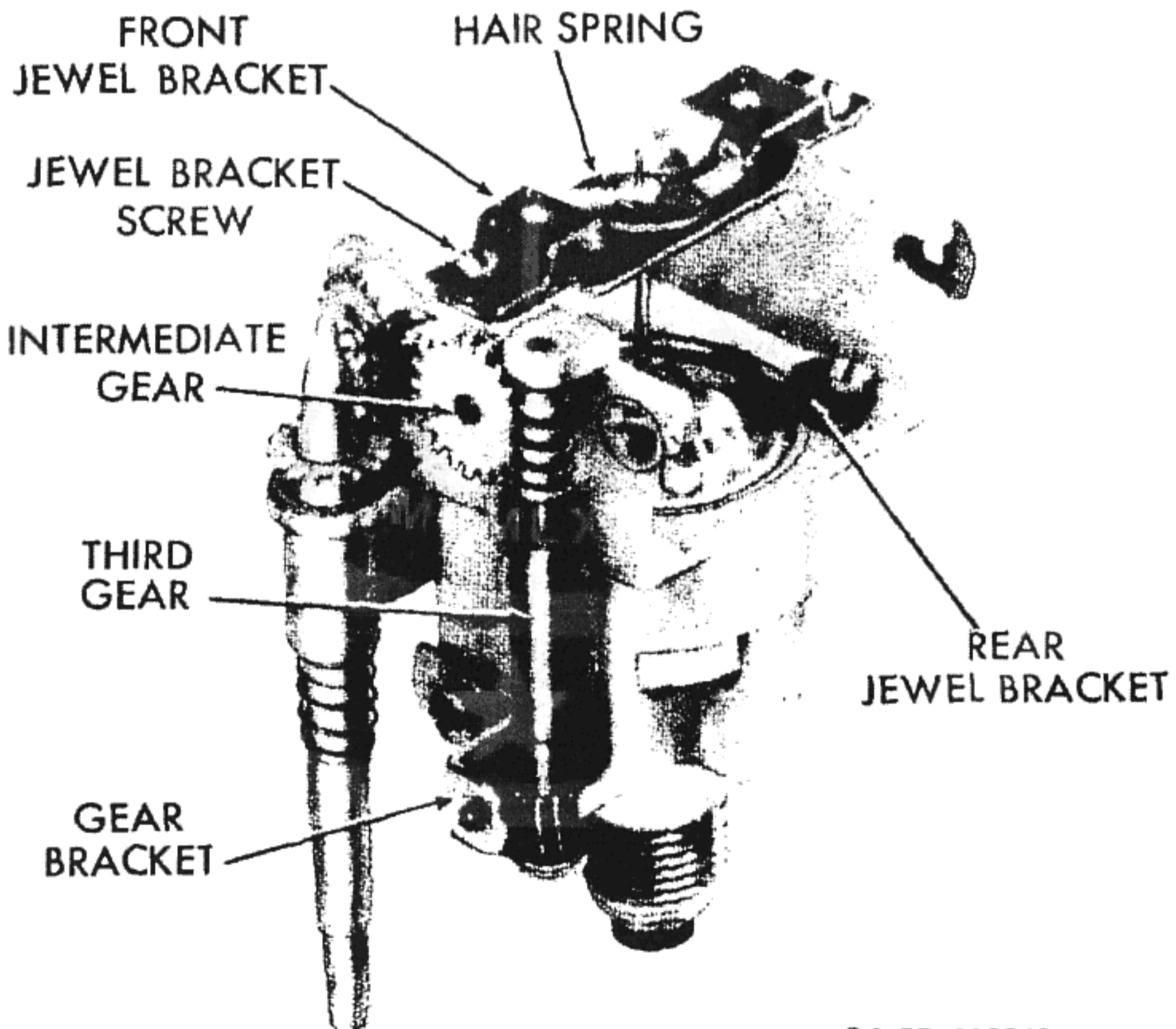

RA PD 318941

**Figure 56—Speedometer Mechanism (Odometers Removed)**



**ORDNANCE MAINTENANCE  
SPEEDOMETERS, TACHOMETERS, AND RECORDERS**

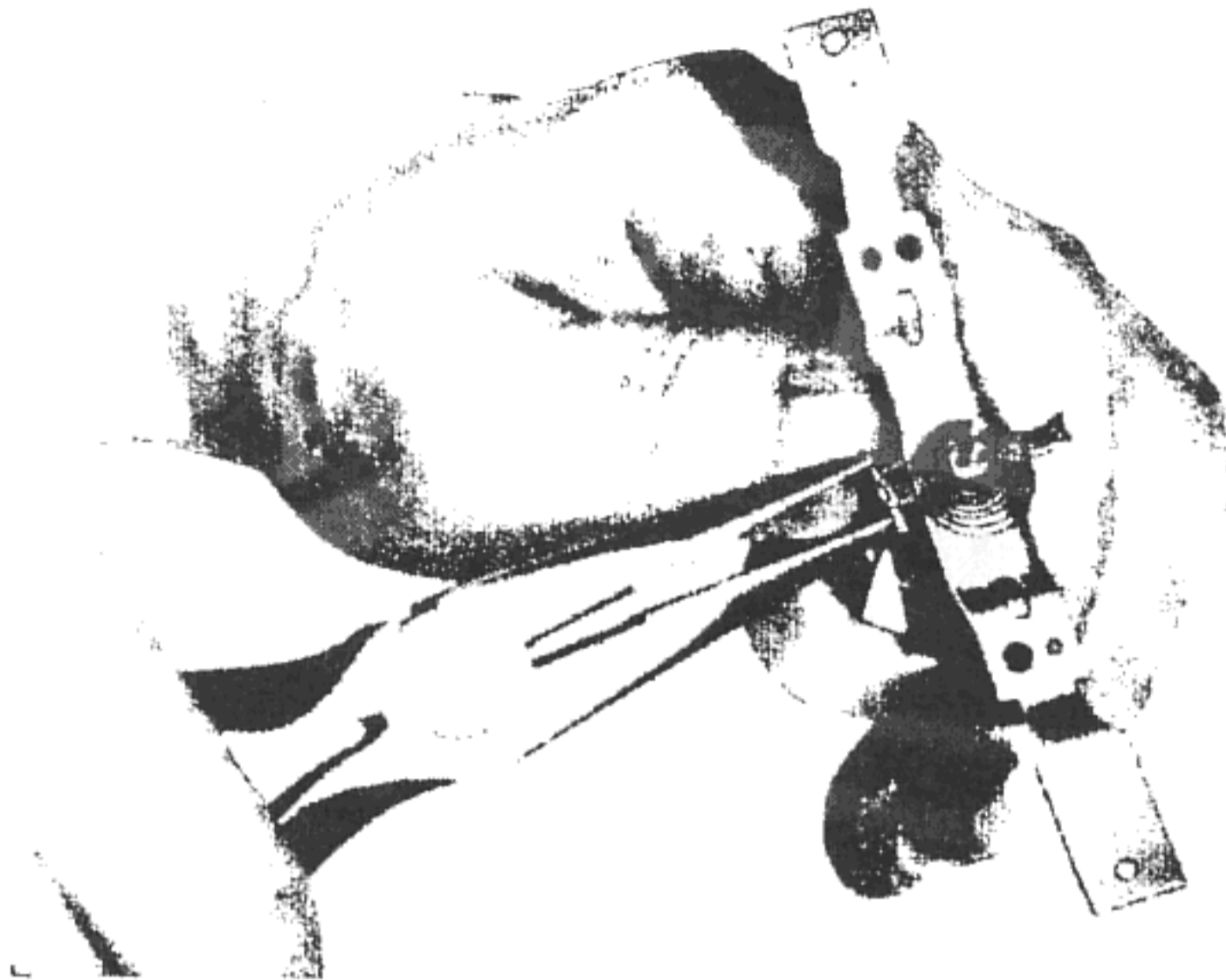

RA PD 318942

**Figure 57—Removing Hair Spring Pin**

*http://jeepdraw.com  
FREE DOWNLOAD  
Thanks to G503.com  
Jon Rogers & Pete Silfven*

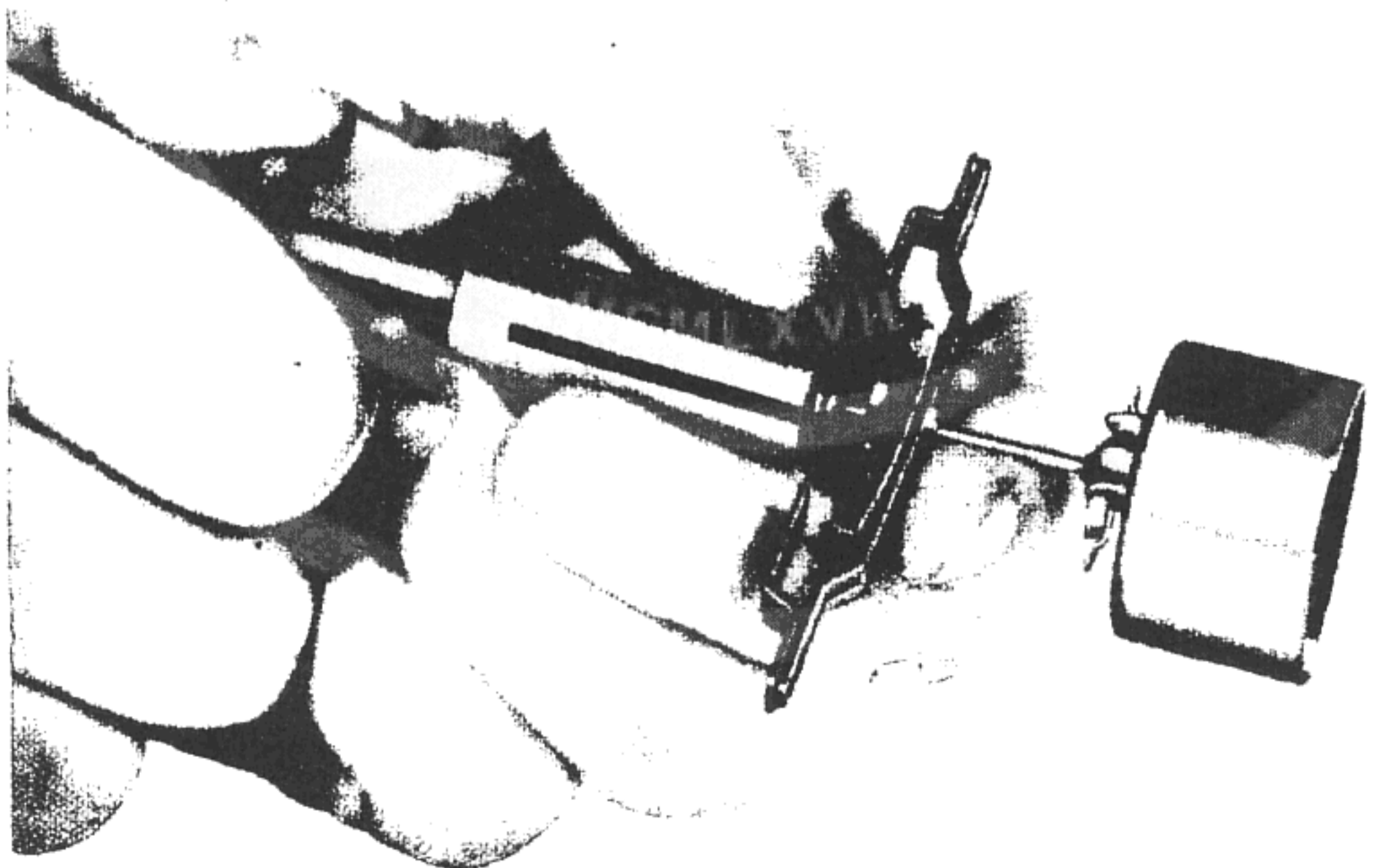

RA PD 318943

**Figure 58—Removing Hair Spring, Using Puller (T-66296)**

## SPEEDOMETERS WITH CUP-TYPE MAGNETS

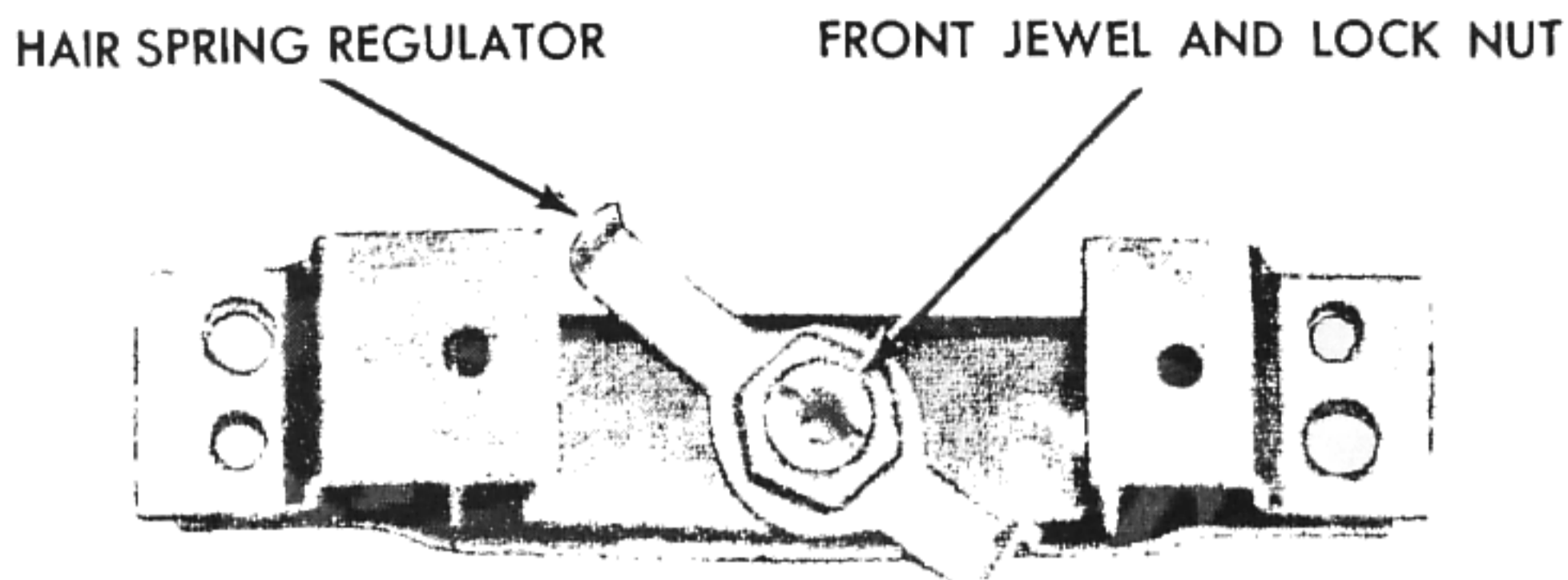

RA PD 318944

**Figure 59—Front Jewel Bracket Assembly**

*http://jeepdraw.com  
FREE DOWNLOAD  
Thanks to G503.com  
Jon Rogers & Pete Silfven*

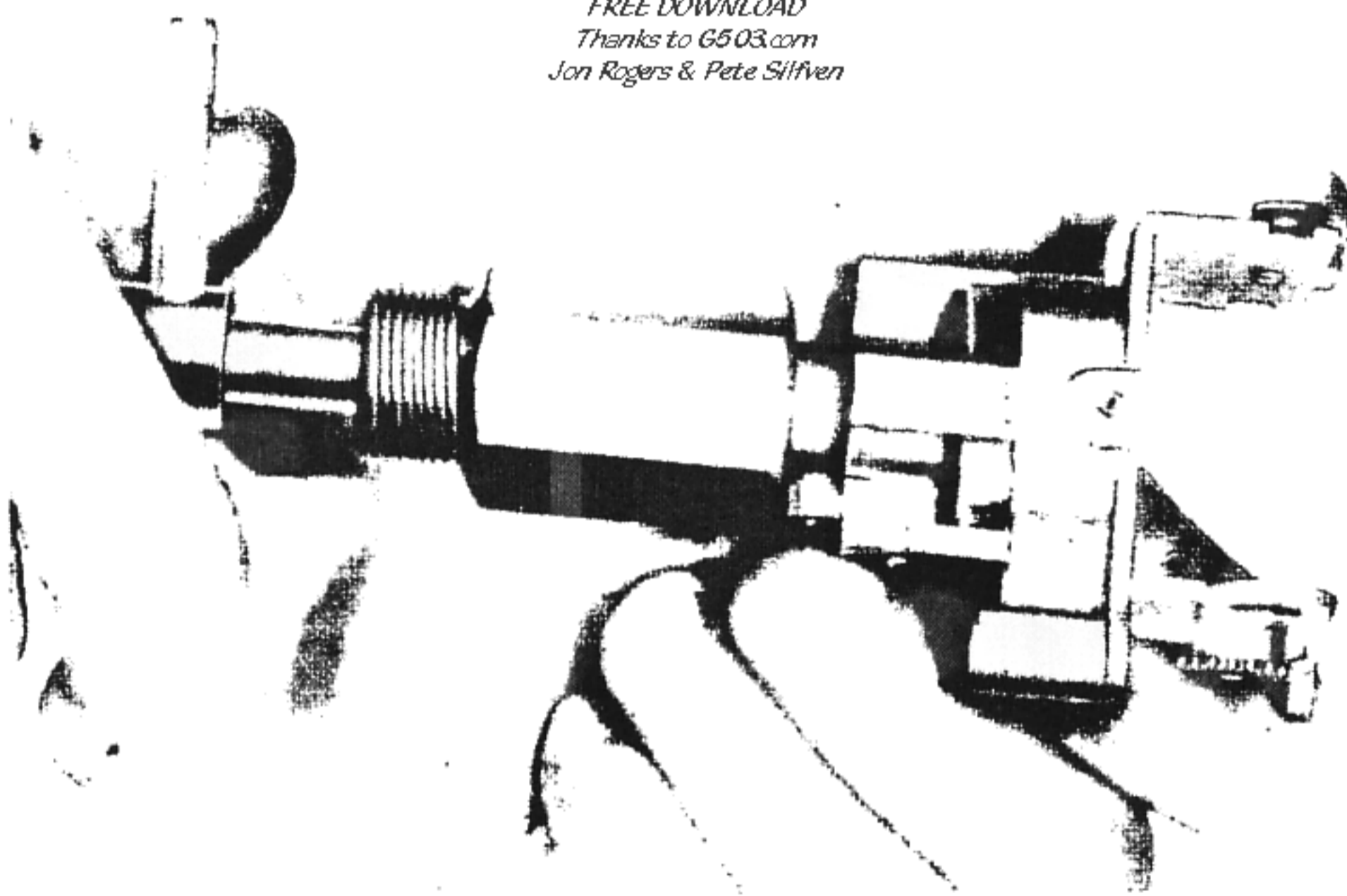

RA PD 318945

**Figure 60—Removing Magnet Shaft Collar, Using Dismantling Wrench (T-170654)**

lifter (T-29 Det 3) (fig. 27) and pry up hair spring far enough to allow claw of puller (T-66296) to enter. Tighten down thumb screw until hair spring comes off (fig. 58). **NOTE:** *This releases the speed cup and staff from the front jewel bracket. Do not lose the tiny fiber thrust washer on the pointer staff.*

**f. Remove Front Jewel and Hair Spring Regulator** (fig. 59). Using  $\frac{1}{4}$ -inch open-end wrench (T-185488) remove front jewel nut and hair spring regulator. Unscrew front jewel from bracket.

## ORDNANCE MAINTENANCE SPEEDOMETERS, TACHOMETERS, AND RECORDERS

**g. Remove Second and Third Gears.** Remove gear bracket by taking out screw (fig. 54). Lift out both second and third gears.

**h. Remove Magnet (Including First Gear).** The second gear must be removed before the magnet can be removed. Assemble body of magnet dismantling wrench (T-170654) to threaded neck of frame, backing off handle so that wrench body will tighten down snugly to frame. Then turn wrench handle clockwise (fig. 60) until collar is pressed off the magnet shaft. Push magnet back to original position and remove collar and rear thrust washer. Using fixture (T-170666)

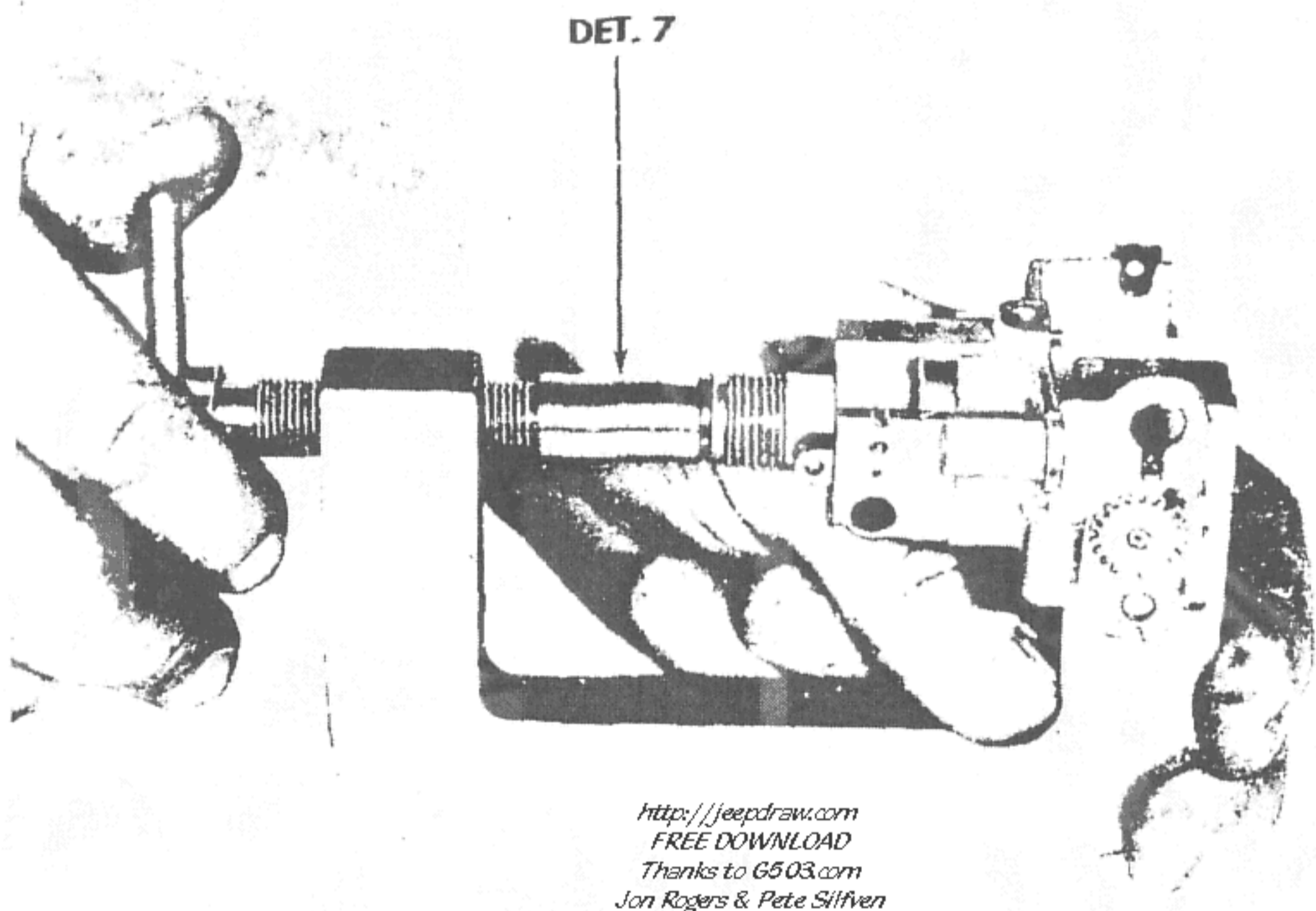

RA PD 318946

**Figure 61—Smoothing Out Flare in Magnet Shaft, Using Fixture (T-170666 with Det 7)**

with adapter (T-170666 Det 7) (fig. 61), tighten down handle to smooth out flare in magnet shaft. **CAUTION:** Care must be taken when using fixture to make sure that it does not come in contact with steel portion of magnet, causing it to be weakened. After smoothing out flare, use safety-edge file (T-170757) to remove any remaining burs from end of magnet shaft (fig. 62) (to prevent scoring bearing surface in frame), then slip magnet and shaft out of frame.

**i. Remove Odometer Intermediate Gear** (fig. 64). It is necessary to remove this gear only when it must be replaced. File off outside end of intermediate gear shaft, and pry off gear (with screwdriver).

**SPEEDOMETERS WITH CUP-TYPE MAGNETS**

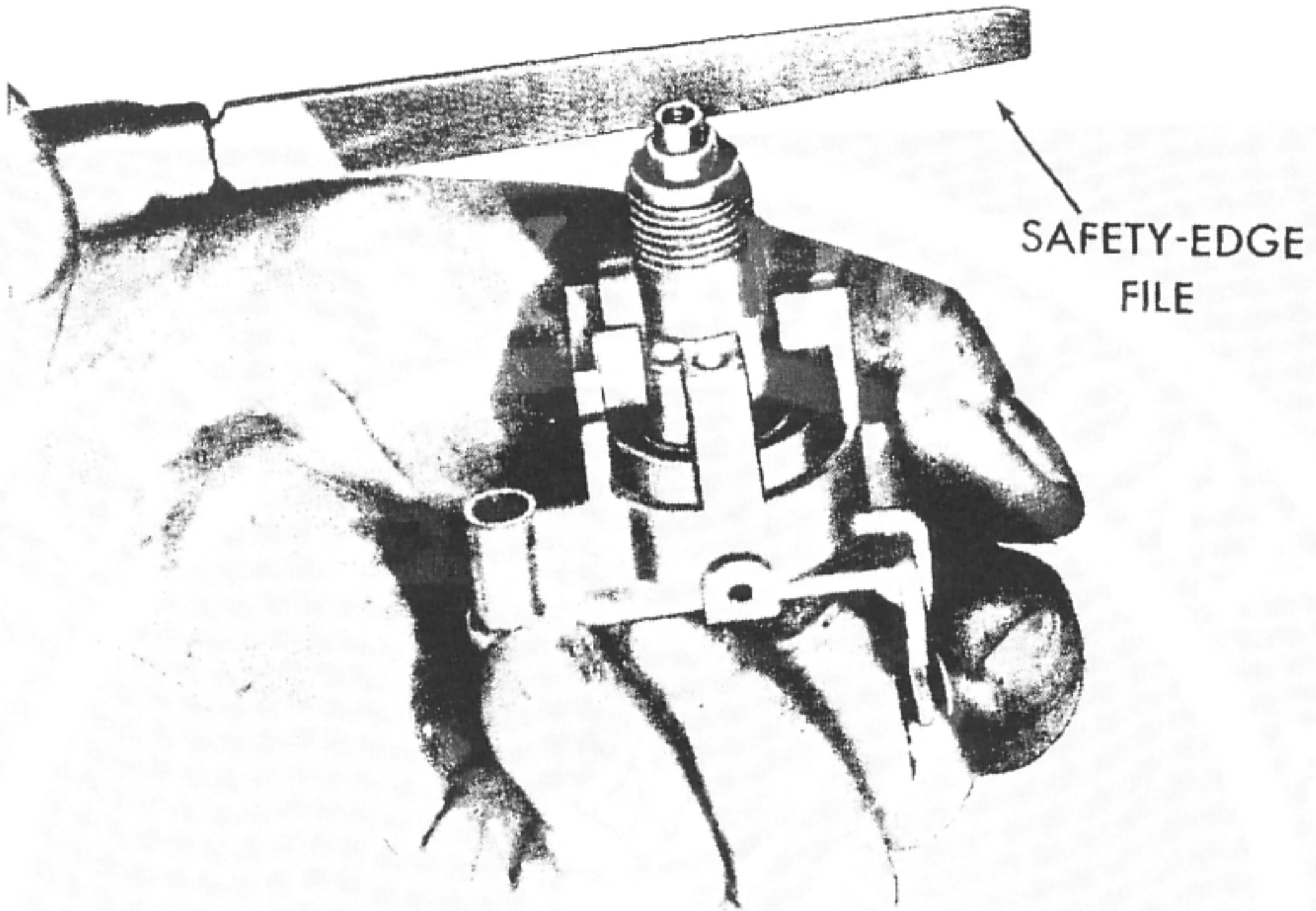

*http://jeepdraw.com*  
*FREE DOWNLOAD*  
*Thanks to G503.com*  
*Jon Rogers & Pete Silfven*

RA PD 318947

**Figure 62—Removing Burs from Magnet Shaft**

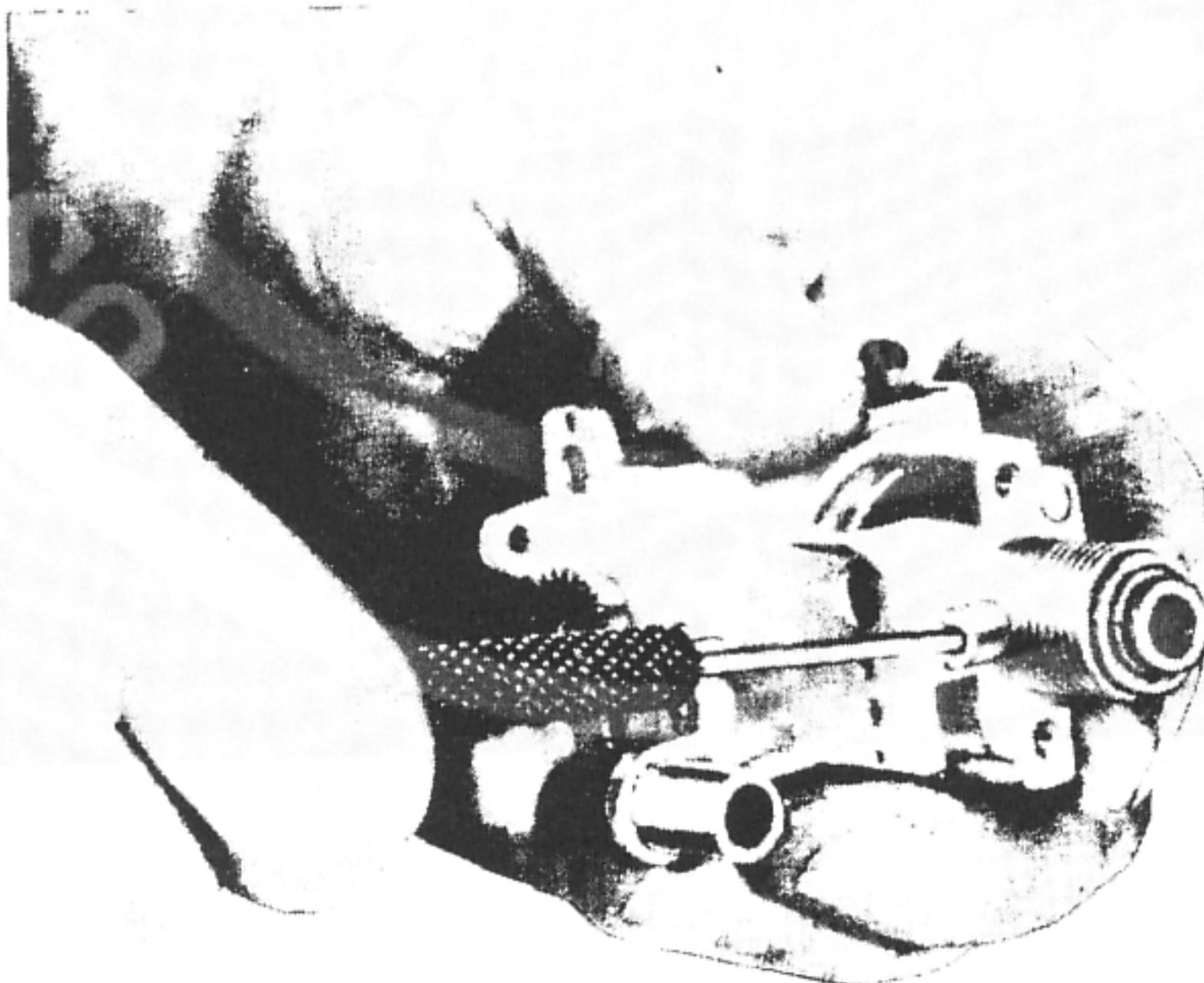

RA PD 318948

**Figure 63—Removing Oil Wick Plug**

**ORDNANCE MAINTENANCE  
SPEEDOMETERS, TACHOMETERS, AND RECORDERS**

j. **Remove Oil Wick.** Using punch, remove oil wick plug from frame (fig. 63). Then lift oil wick out of frame (using tweezers).

**30. CLEANING, INSPECTION, AND REPAIR OF PARTS.**

a. **General Cleaning.** Thoroughly clean hair spring, speed cup, second gear, third gear, frame, brackets, screws, and metal washers with brush (T-170755) and dry-cleaning solvent. Make sure to remove every trace of grease, dirt, and lint so that any defects will be

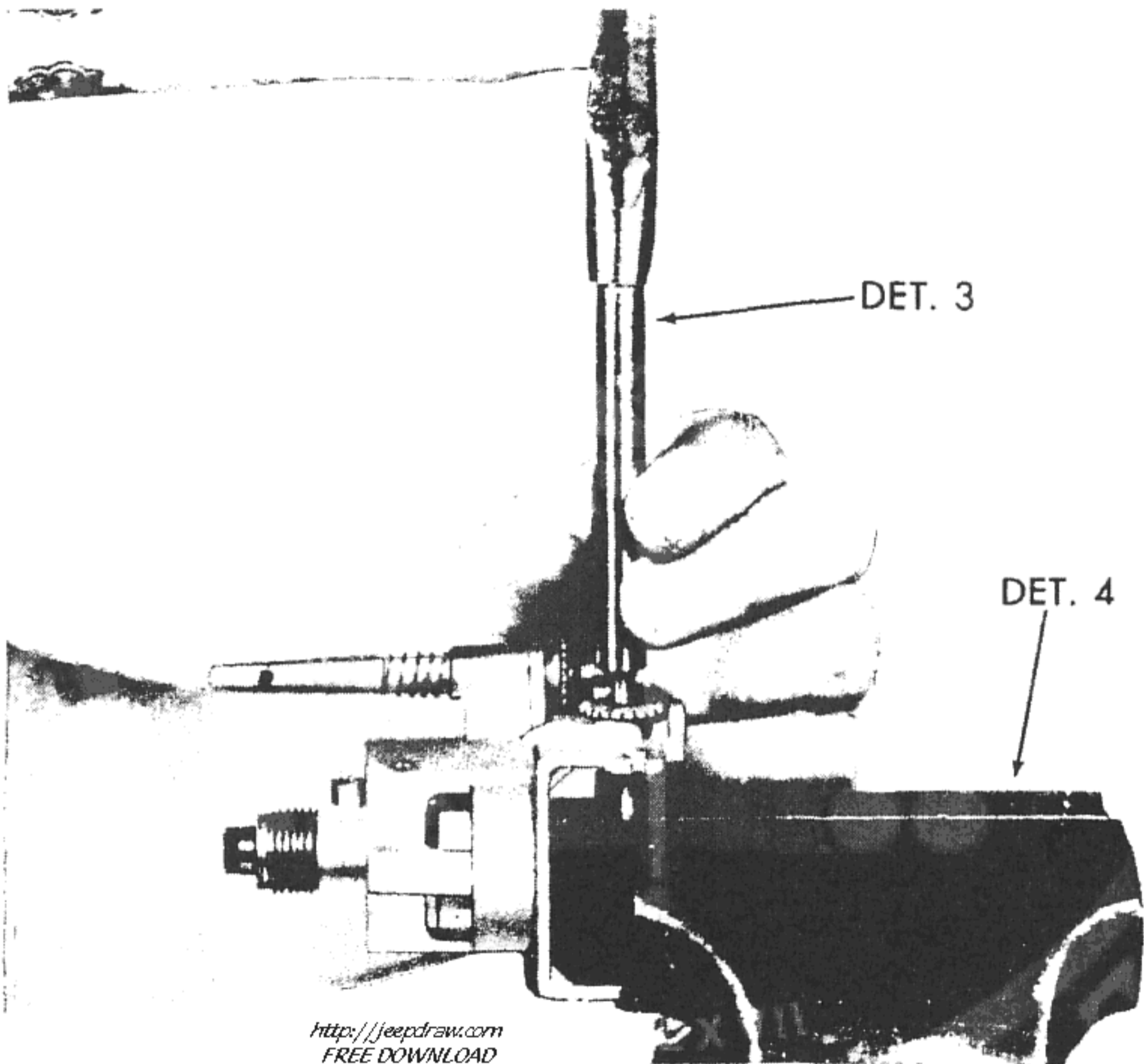

*http://jeepdraw.com  
FREE DOWNLOAD  
Thanks to G503.com  
Jon Rogers & Pete Silfven*

RA PD 318949

**Figure 64—Staking Intermediate Gear, Using Fixture (T-178717)**

easily found. Carefully dry parts with compressed air. Wipe other parts clean with a rag.

b. **Front and Rear Jewels.** Sharpen a match or orange stick to a fine point and use for cleaning jewels. Using jeweler's eyepiece, inspect jewels closely to see that they are not cracked or broken. If defective, they must be replaced. A special process synthetic jewel is used in Stewart-Warner instruments which must not under any circumstances be lubricated, as oil in jewels will cause erratic operation of unit.

## SPEEDOMETERS WITH CUP-TYPE MAGNETS

c. **Speed Cup and Staff.** If the ends of the staff are oxidized or tarnished and cannot be readily cleaned to a bright finish, replace the speed cup and staff assembly. Using jeweler's eyepiece, inspect ends of staff for wear. If badly worn, replace assembly. Hold ends of staff between thumb and forefinger, and spin cup to see that it runs true and is not bent or otherwise damaged. **NOTE:** *This assembly must be handled very carefully to prevent its being thrown out of balance, out of line, etc.*

d. **Magnet (Including First Gear).** If magnet shaft shows excessive wear, if squared connection for cable tip is damaged, or if first gear is worn, magnet and shaft must be replaced. Care must be taken so that magnet does not come in contact with tools, metal objects, etc., as this will cause magnet to lose its strength.

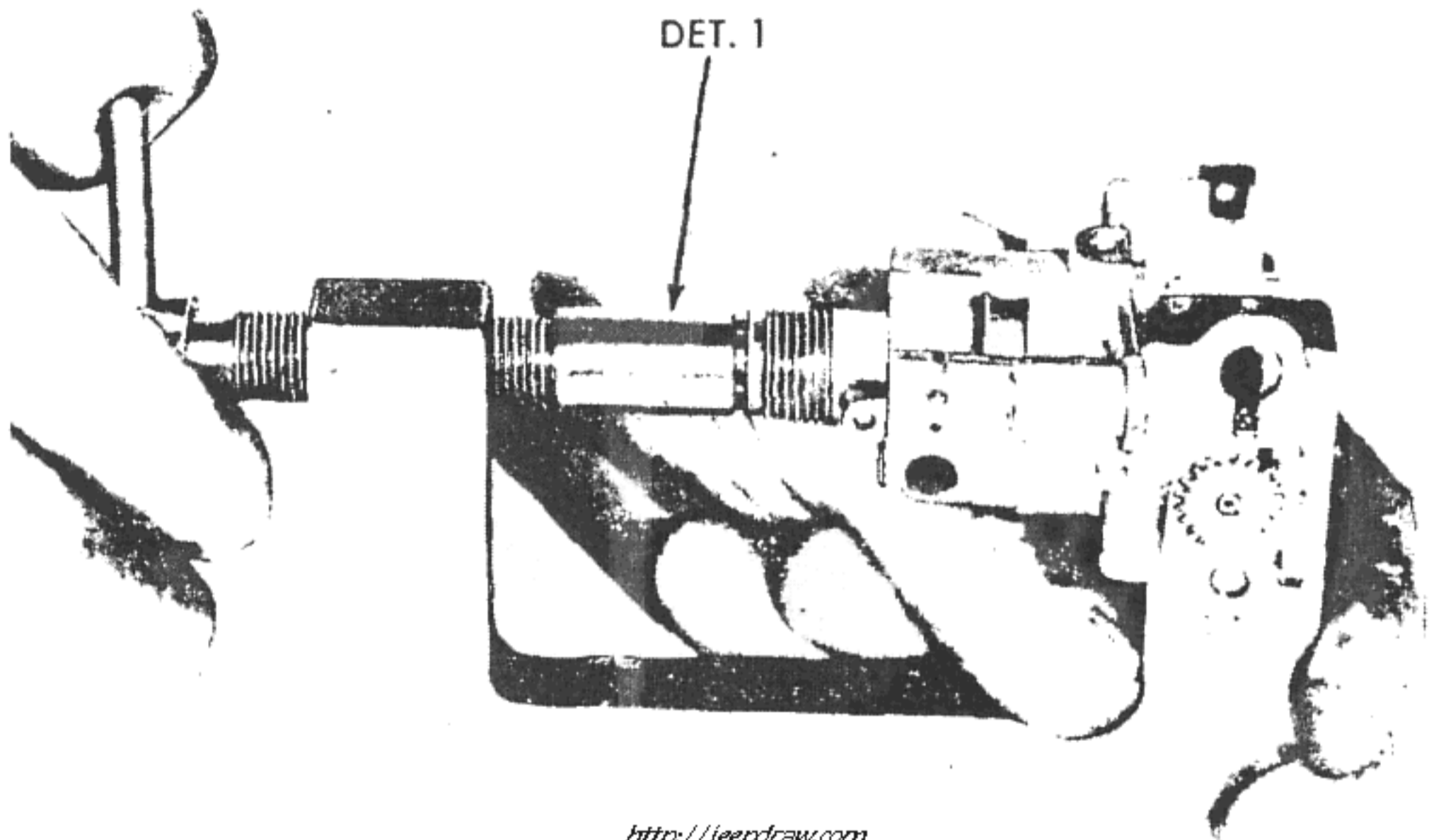

<http://jeepdraw.com>  
 FREE DOWNLOAD  
 Thanks to G503.com  
 Jon Rogers & Pete Silfven

RA PD 318950

**Figure 65—Pressing Collar on Magnet Shaft, Using Fixture (T-170666 with Det 1)**

e. **Hair Spring.** The hair spring should lie perfectly flat, and coils should be evenly spaced and not touch each other at any point. If hair spring is bent out of shape and cannot be readily straightened with tweezers, discard.

f. **Odometers.** Wipe dials clean with rag. Do not wash in dry-cleaning solvent, as lubricant will be removed. Inspect for free movement of figure wheels, and see that gear teeth are intact. If defective, discard complete assembly.

g. **Main Frame.** Inspect bearing surface (for magnet shaft) for wear or scoring. Be sure all threads are in good condition, and that

## ORDNANCE MAINTENANCE SPEEDOMETERS, TACHOMETERS, AND RECORDERS

field plate is in place. If intermediate gear has not been removed inspect for excessive looseness, and for worn or damaged teeth.

**h. Second and Third Gears.** Inspect for excessive wear and broken teeth. If defective, discard.

### 31. ASSEMBLY AND CALIBRATION.

**a. Replace Odometer Intermediate Gear Assembly.** Place washer over odometer drive gear shaft and place shaft through frame with drive gear on inside. Place another washer over shaft (outside of frame). Rest end of drive gear shaft on anvil of staking fixture

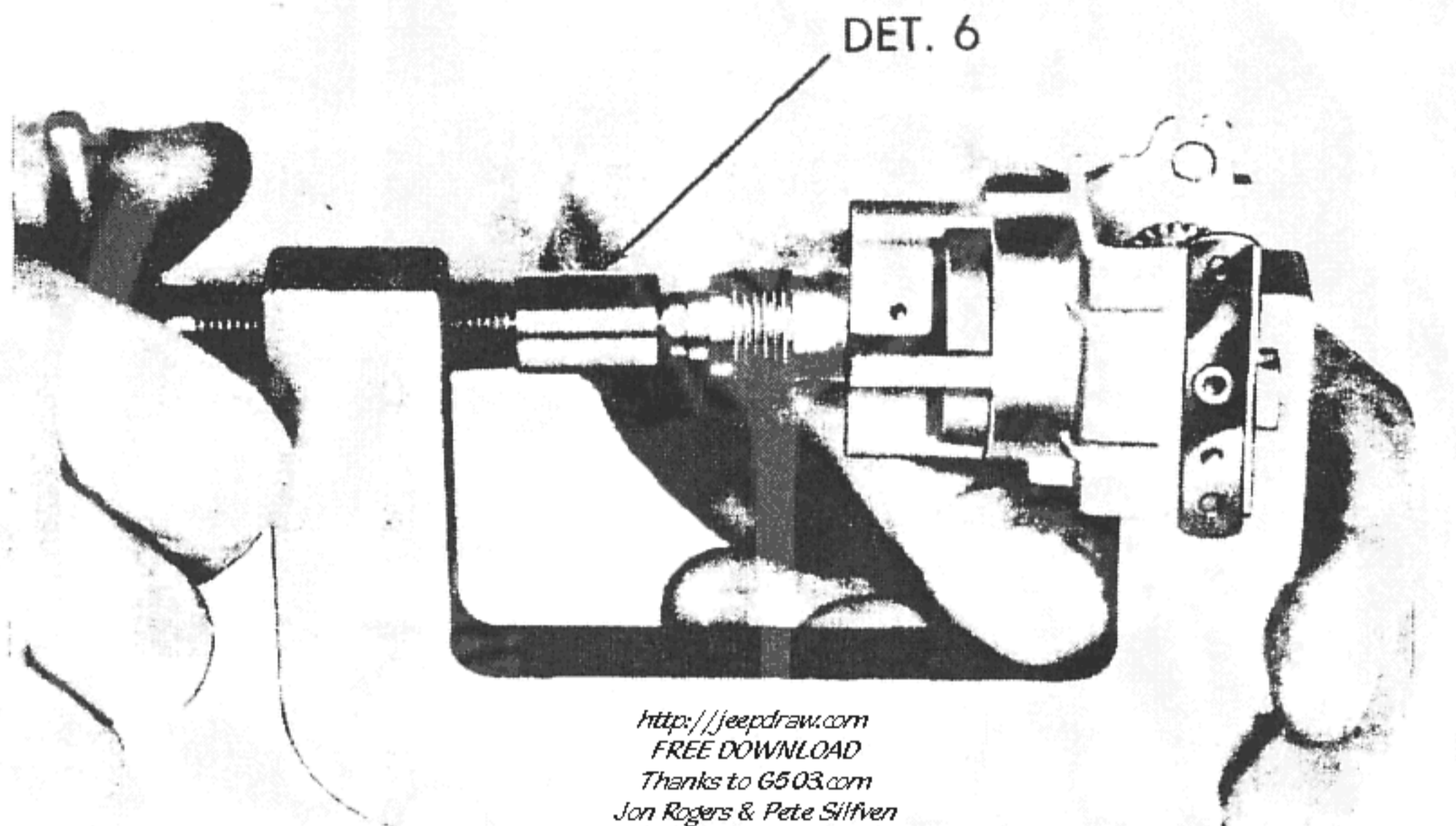

*http://jeepdraw.com  
FREE DOWNLOAD  
Thanks to G503.com  
Jon Rogers & Pete Silfven*

RA PD 318951

**Figure 66—Flaring Magnet Shaft, Using Fixture  
(T-170666 with Det 6)**

(T-178717 Det 4) held in vise. Using female punch, drive spur gear on shaft as far as it will go. Using staking tool (T-178717 Det 3) stake outside end of drive gear shaft securely (fig. 64). Check to see that gear turns freely.

**b. Replace Magnet (Including First Gear).** Place front thrust washer over magnet shaft. Lubricate first gear (on magnet shaft) with small amount of No. 00 Grease O.D. Lubricate shaft with watch and clock oil and place in frame. Place rear thrust washer and magnet shaft collar over end of shaft. Using magnet assembly fixture (T-170666 with Det 1), tighten down (fig. 65) until collar is pressed all the way onto shaft. **CAUTION:** Care must be taken when using fixture to make sure that it does not come in contact with steel

## SPEEDOMETERS WITH CUP-TYPE MAGNETS

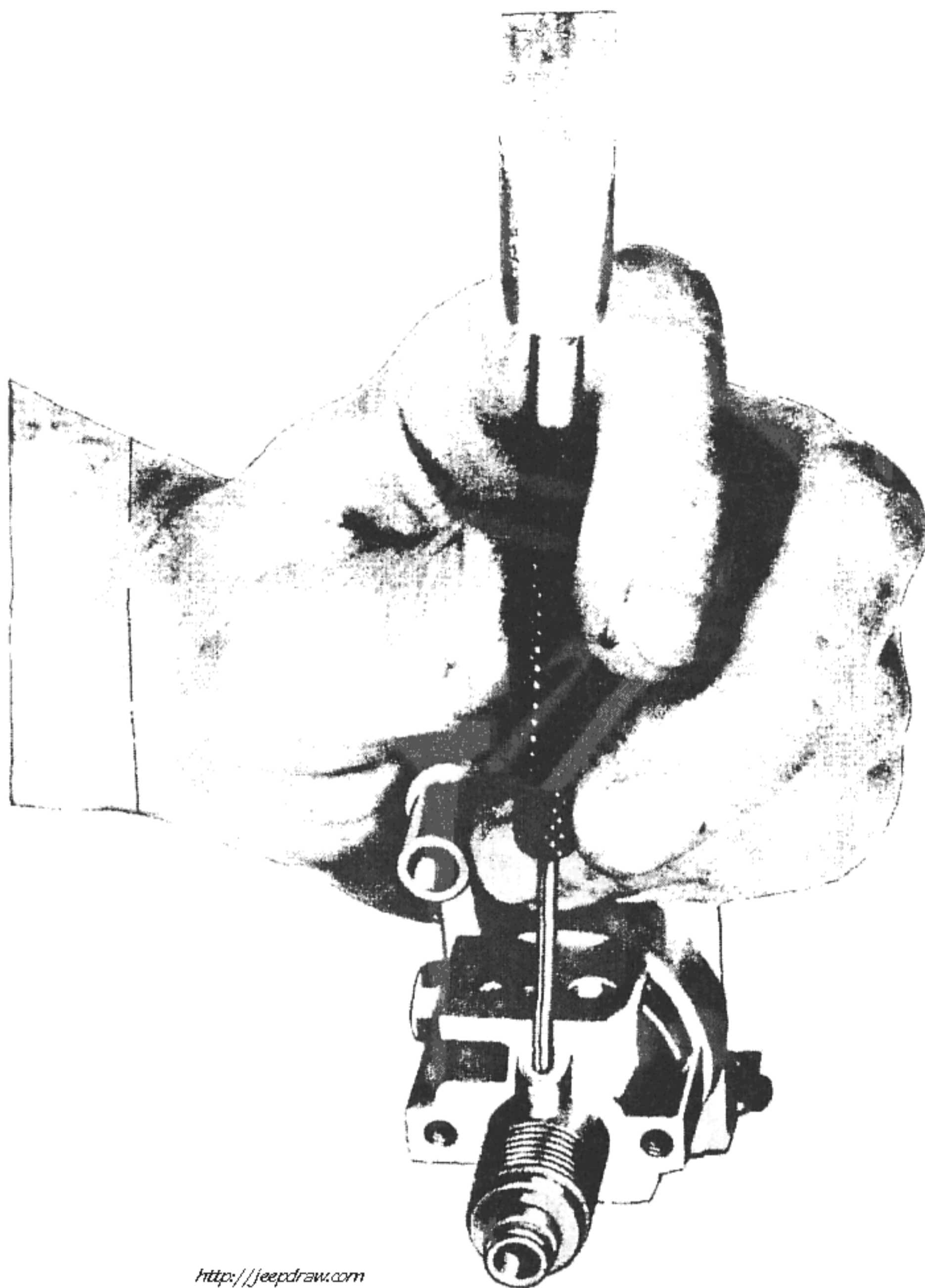

*http://jeepdraw.com*  
*FREE DOWNLOAD*  
*Thanks to G503.com*  
*Jon Rogers & Pete Silfven*

RA PD 318952

**Figure 67—Replacing Oil Wick Plug**

*portion of magnet, causing it to be weakened. Using fixture (T-170666 with Det 6) flare end of magnet shaft (fig. 66). Allow about 0.003-inch end play (barely perceptible) in magnet shaft. Check to see that magnet turns freely.*

**c. Replace Oil Wick and Plug.** Saturate oil wick in watch and clock oil and place in frame. Using punch, tap oil wick plug into place (fig. 67).



## ORDNANCE MAINTENANCE SPEEDOMETERS, TACHOMETERS, AND RECORDERS

d. **Replace Second and Third Gears.** Lubricate gear teeth with small amount of No. 00 Grease, O.D. Do not overlubricate. Place second gear and third gears in position, and fasten with bracket and screw (fig. 54). Test for free turning and end play (about 0.004 inch). End play can be adjusted by bending gear bracket.

e. **Replace Front Jewel and Hair Spring Regulator (fig. 59).** Screw front jewel into bracket. Place hair spring regulator in position and screw on front jewel nut, but do not tighten. Place tiny thrust washer over end of speed cup staff, and place speed cup and staff in front jewel bracket. Temporarily place speed cup and front jewel

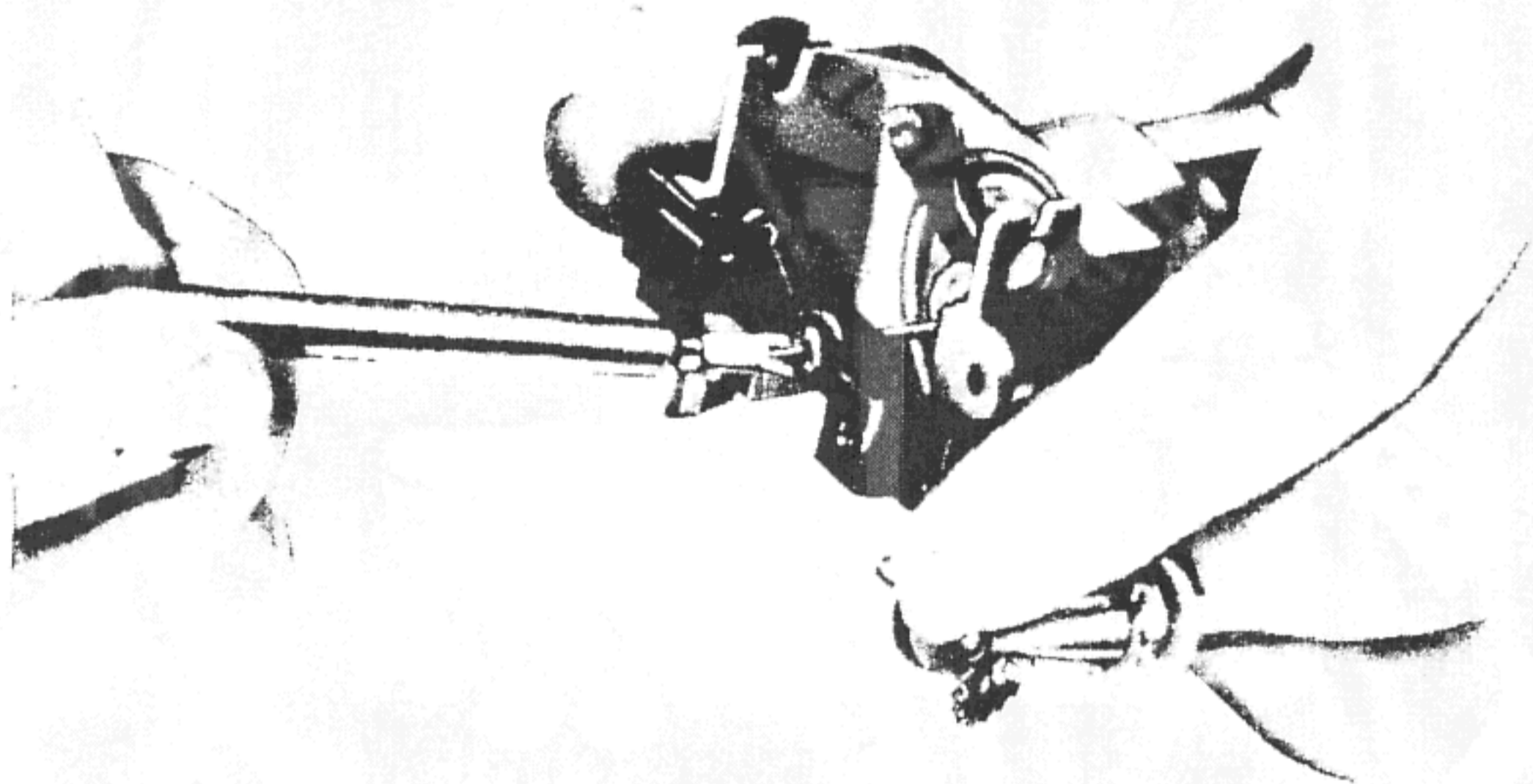

*http://jeepdraw.com  
FREE DOWNLOAD  
Thanks to G503.com  
Jon Rogers & Pete Silfven*

RA PD 318953

**Figure 68—Adjusting Front Jewel, Using Special Tool (T-178705)**

bracket in frame. Fasten rear jewel bracket in place. While holding front jewel bracket securely in place, adjust front jewel, using adjuster (T-178705), allowing about 0.003-inch staff end play (fig. 68). Tighten upper jewel nut securely, using  $\frac{1}{4}$ -inch open-end wrench. Be sure hair spring regulator is in correct position with slotted end toward odometer intermediate gear. Remove rear jewel bracket, allowing speed cup to be lifted out of frame.

f. **Test Magnet Strength to Determine Proper Hair Spring.** Pry split field ring out of frame. Place magnet strength tester (408165) on frame and magnet assembly. Place assembly on calibrating machine (fig. 69), run master at 60 miles per hour (chapter 13) and take reading on tester. Replace field ring. Determine pointer

**SPEEDOMETERS WITH CUP-TYPE MAGNETS**

deflection (in degrees) at 60 miles per hour of speedometer being repaired from following list. If the model number of speedometer being repaired does not appear in this list, the angle of pointer travel from zero to 60 miles per hour on the dial may be easily determined with a protractor. Then refer to "Hair Spring Chart" on page 82 to determine proper tension hair spring to use, and select hair spring from kit (408082).

Speedometer Model No.	Pointer Deflection (in degrees) at 60 mph (1,000 rpm)	Speedometer Model No.	Pointer Deflection (in degrees) at 60 mph (1,000 rpm)
579-P	108	589-D	245
579-R	180	589-Z	245
579-V	196	589-AL	253
579-X	180	590-X	232
579-Y	108	590-AB	235
579-Z	84	590-AD	235
579-AA	159	590-AE	235
579-AB	161	590-AF	197
581-B	65	590-AJ	234
		590-AM	235

MAGNET STRENGTH TESTER  
(FRAME AND MAGNET ASSEMBLY INSIDE TESTER)

*http://jeepdraw.com*  
FREE DOWNLOAD  
Thanks to G503.com  
Jon Rogers & Pete Silfven

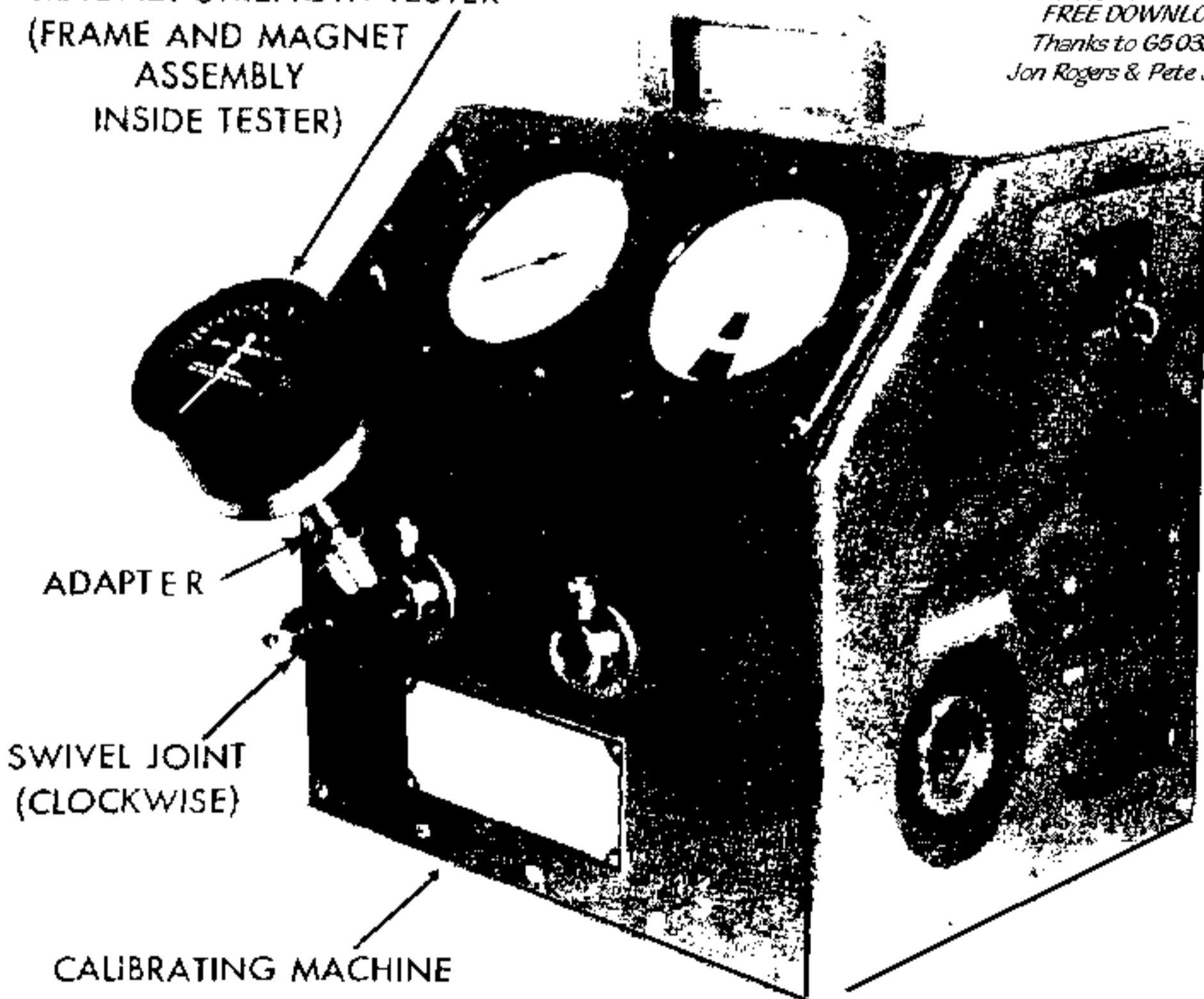

RA PD 318954

**Figure 69—Magnet Strength Tester (408165) (on Frame and Magnet Assembly) Attached to Calibrating Machine (T-170645)**

### HAIR SPRING CHART

Pointer Deflection (in degrees) at 60 mph (1,000 rpm)	Magnet Strength Tester Reading at 60 mph or 1,000 rpm										
	1	2	3	4	5	6	7	8	9	10	11
60- 70	110	110	110	112	114	114	114	114			
70- 80	110	110	110	110	112	112	114	114			
80- 90	108	108	110	110	110	112	112	114	114		
90-100	106	108	108	108	110	110	112	112	114		
100-110	106	106	108	108	108	110	110	112	114	114	
110-120	104	104	106	106	108	110	110	112	112	114	
120-130	104	104	106	106	108	108	110	110	112	114	
130-140	102	104	104	104	106	108	108	110	112	112	114
140-150	100	102	104	104	106	108	108	110	110	112	114
150-160	100	100	102	104	104	106	108	108	110	112	114
160-170	98	100	102	102	104	106	106	108	110	110	112
170-180	98	98	100	102	104	104	106	108	110	110	112
180-190	96	98	100	100	102	104	106	106	108	110	112
190-200	96	98	98	100	102	104	104	106	108	110	112
200-210	94	96	98	98	100	104	104	106	108	110	110
210-220	94	96	96	98	100	102	104	104	108	108	110
220-230	92	94	96	98	100	102	104	104	106	108	110
230-240	92	94	96	96	98	100	102	104	106	108	110
240-250	90	92	94	96	98	100	102	104	106	108	110
250-260	90	92	94	96	98	100	102	104	106	108	110

**ORDNANCE MAINTENANCE**  
**SPEEDOMETERS, TACHOMETERS, AND RECORDERS**

<http://jeepdraw.com>  
 FREE DOWNLOAD

Thanks to G503.com  
 Jon Rogers & Pete Siffen

SPEEDOMETERS WITH CUP-TYPE MAGNETS

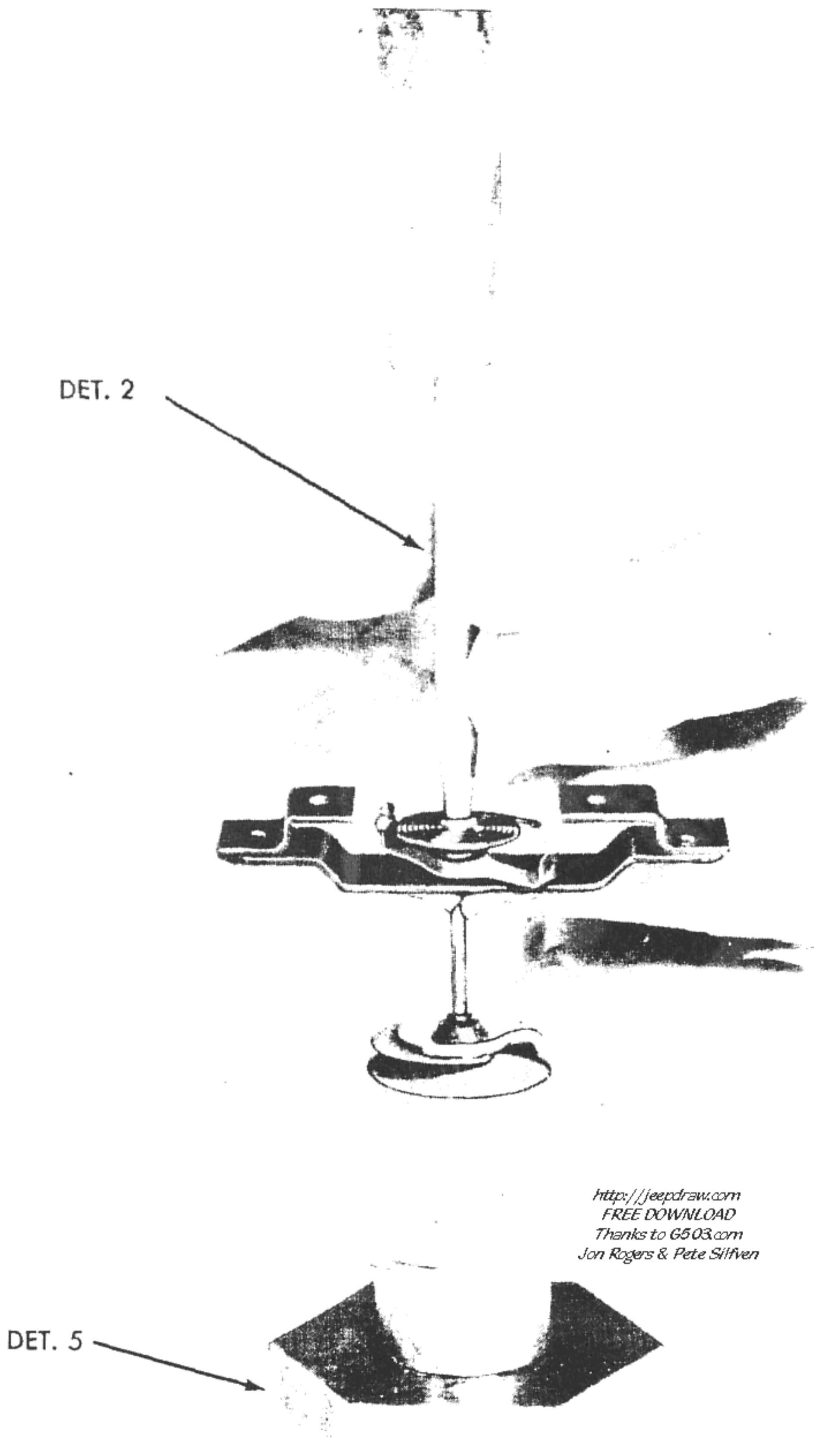

*http://jeepdraw.com  
FREE DOWNLOAD  
Thanks to G503.com  
Jon Rogers & Pete Silfven*

RA PD 318955

**Figure 70—Replacing Hair Spring, Using Assembly Kit (T-29)**

## ORDNANCE MAINTENANCE SPEEDOMETERS, TACHOMETERS, AND RECORDERS

g. **Replace Hair Spring** (fig. 70). Place speed cup on anvil of hair spring assembly fixture (T-29 Det 5). Be sure tiny thrust washer is over end of speed cup staff, and place front jewel bracket over end of staff. Place hair spring over end of staff with loose end of spring pointing counterclockwise. Using female punch (T-29 Det 2) carefully drive hair spring on staff leaving about  $\frac{1}{8}$ -inch clearance between hair spring collet and front jewel.

h. **Replace Speed Cup and Front Jewel Bracket** (fig. 56). Place speed cup, front jewel bracket, and hair spring assembly in frame.

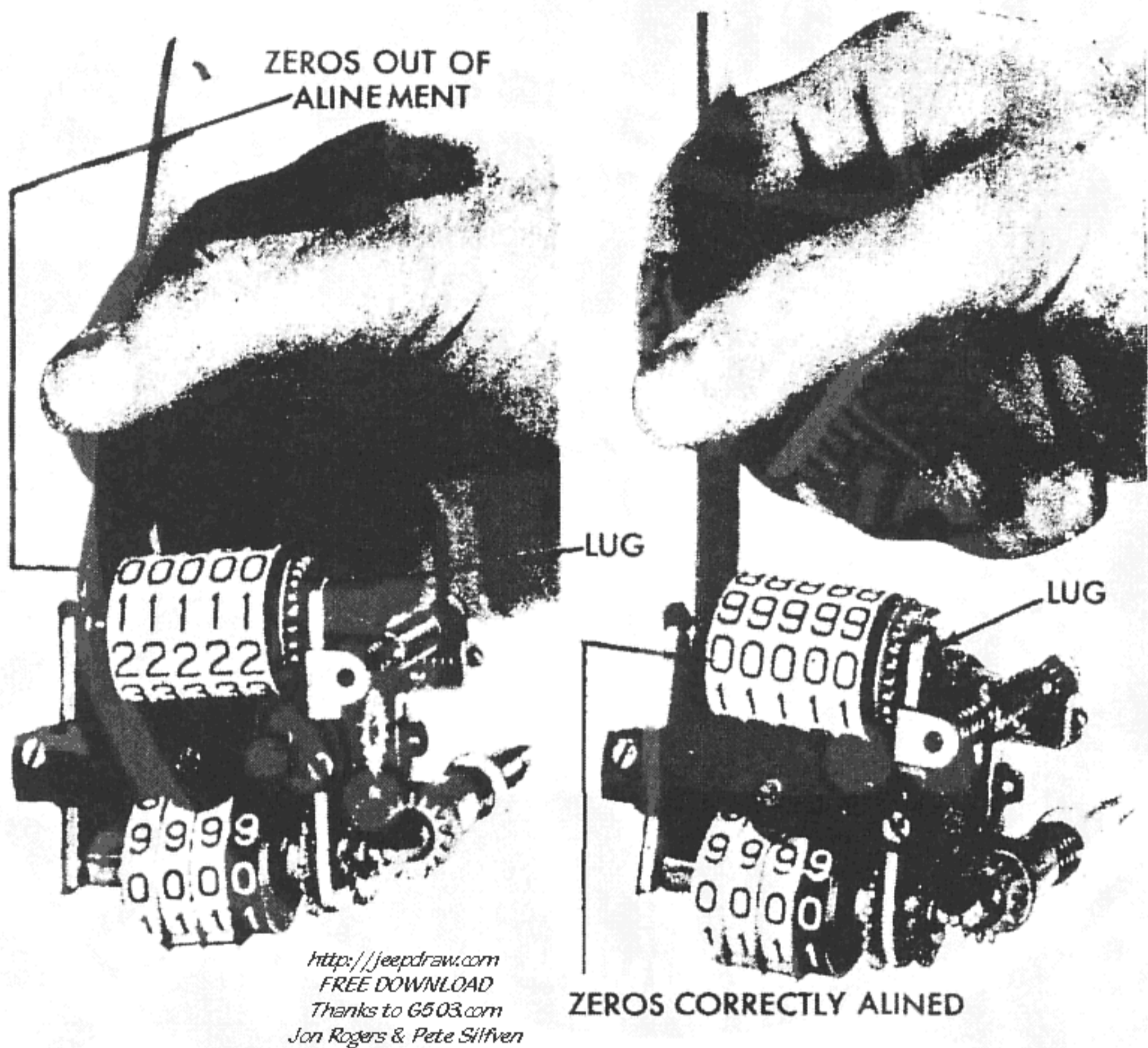

RA PD 318956

**Figure 71—Alining Total Odometer Figure Wheels with Dial Window, Using Spanner Wrench (T-40783)**

Insert rear jewel bracket, and fasten in place. Then fasten upper jewel bracket in place. Test speed cup for free turning and end play.

i. **Replace Hair Spring Pin and Aline Hair Spring.** Insert end of hair spring in hair spring regulator (counterclockwise direction) with end of spring protruding through slot about  $\frac{1}{8}$  inch. Using long-nosed pliers, place one jaw of pliers on large end of pin and other jaw on hair spring regulator and squeeze pin tightly in position (with small end of pin pointing clockwise) (fig. 57). Using adjuster

## SPEEDOMETERS WITH CUP-TYPE MAGNETS

(T-51742) turn hair spring collet on staff (fig. 72) until speed cup stop rests against rear jewel bracket and so that hair spring tends to pull speed cup in counterclockwise direction. Using tweezers, carefully line up hair spring so that coils are equally spaced and do not touch one another when speed cup is in any position.

### j. Replace Odometer Assemblies.

(1) For units with season odometer above and trip odometer below speed cup staff (fig. 54), place reset gear in frame, place reset

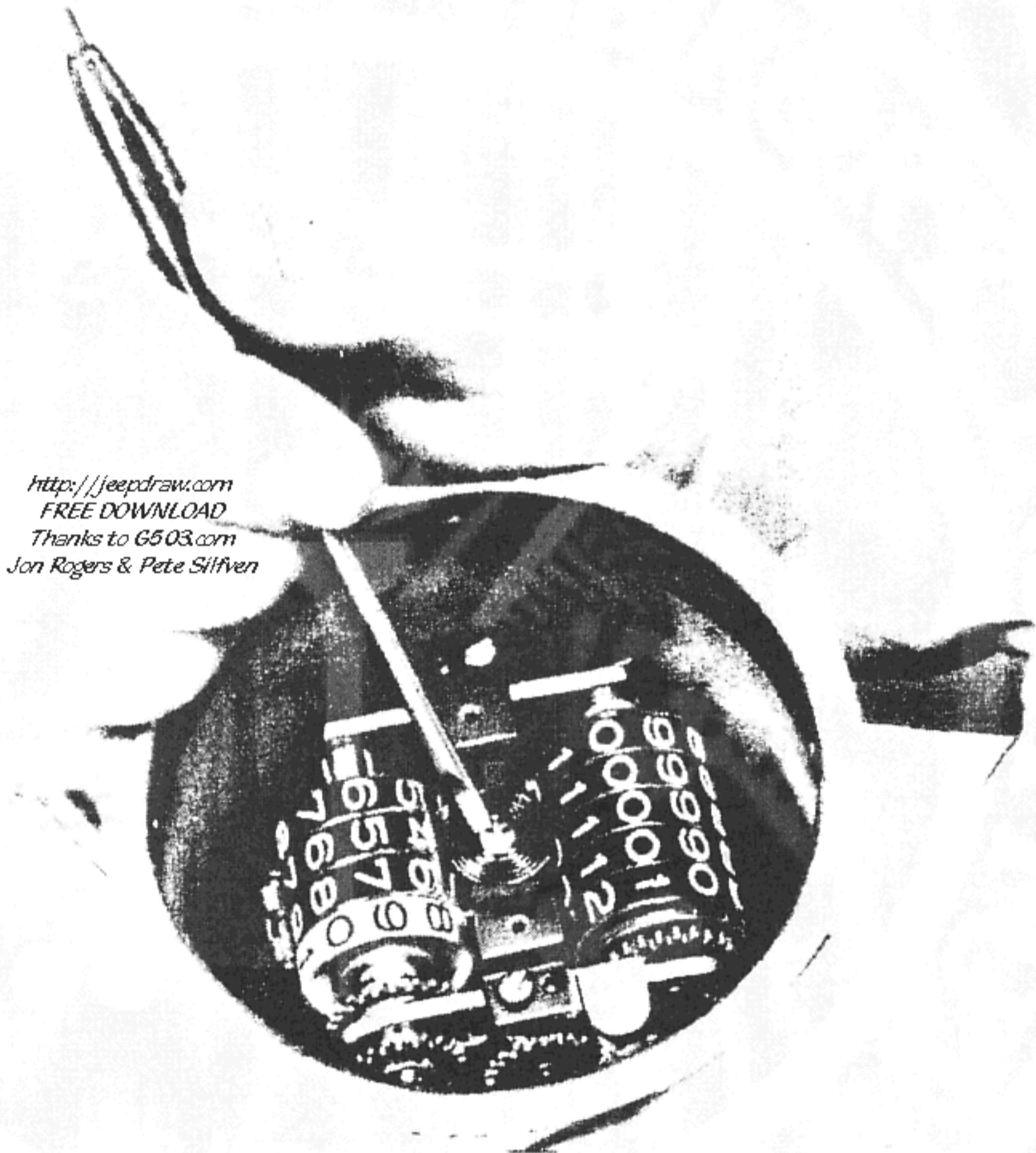

*http://jeepdraw.com  
FREE DOWNLOAD  
Thanks to G503.com  
Jon Rogers & Pete Silfven*

RA PD 318957

**Figure 72—Adjusting Hair Spring Tension by Turning Collet on Staff, Using Adjuster (T-51742)**

spring and drive gear on trip odometer shaft, and slip trip odometer in the frame. If the reset shaft and gear are detachable, they must be placed in the frame before trip odometer is replaced. Fasten cross bar in position with retaining screw. Replace total odometer making sure that lug fits in slot in frame and that hole in spring clip fits over end of shaft. If a new odometer is used it may be necessary to line up the figure wheels, as the shaft lug on the new odometer may be in a different position than the lug on the old odometer. To correct this, place spanner wrench (T-40783) on the shaft and hook into keyway,

**ORDNANCE MAINTENANCE  
SPEEDOMETERS, TACHOMETERS, AND RECORDERS**

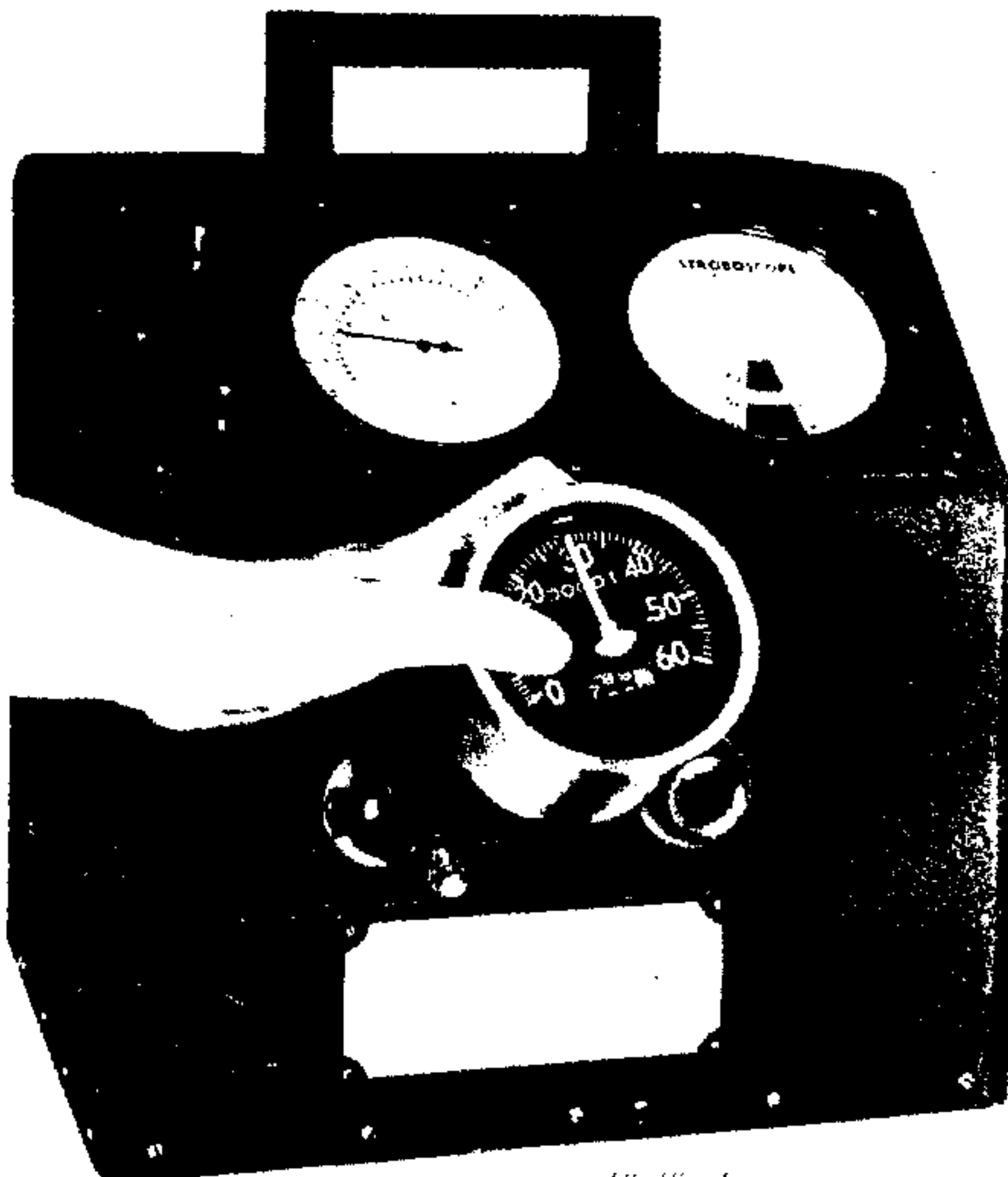

*http://jeepdraw.com  
FREE DOWNLOAD  
Thanks to G503.com  
Jon Rogers & Pete Silven*

RA PD 318958

**Figure 73—Holding Speedometer on Calibrating Machine (T-170645) and Testing at 30 mph**

then turn shaft until zeros are in proper position to appear in the dial window (fig. 71).

(2) For units with total and trip odometers in line (fig. 55), place reset gear in frame, place reset spring and tenth dial gear on trip odometer shaft, and place trip odometer in position on total odometer bracket. Then place complete assembly in frame and fasten with screw and spring clip.

(3) After replacing odometers, test for binds in odometer gearing.

**SPEEDOMETERS WITH CUP-TYPE MAGNETS**

k. **Replace Case.** Place mechanism in case, and fasten with two screws and lock washers.

l. **Calibrate.** Refer to chapter 13. Place dial in position and press pointer lightly on staff at zero. Place unit on calibrating machine, hold in same position as it will be on vehicle, run master head on machine at 10 miles per hour and make any necessary corrections in instrument by adjusting hair spring collet on staff (fig. 72). Allow pointer to return to zero to check whether it returns easily. Run master at 30 and 60 miles per hour (fig. 73). If instrument reads 5 miles or more fast at high speeds, shorten the hair spring. Cutting off one coil will slow up instrument approximately 6 miles per hour. (Not more than three coils should be removed.) If instrument reads 5 miles or more slow at high speeds and is equipped with a strong-tension hair spring, a weaker hair spring must be installed to eliminate slow-

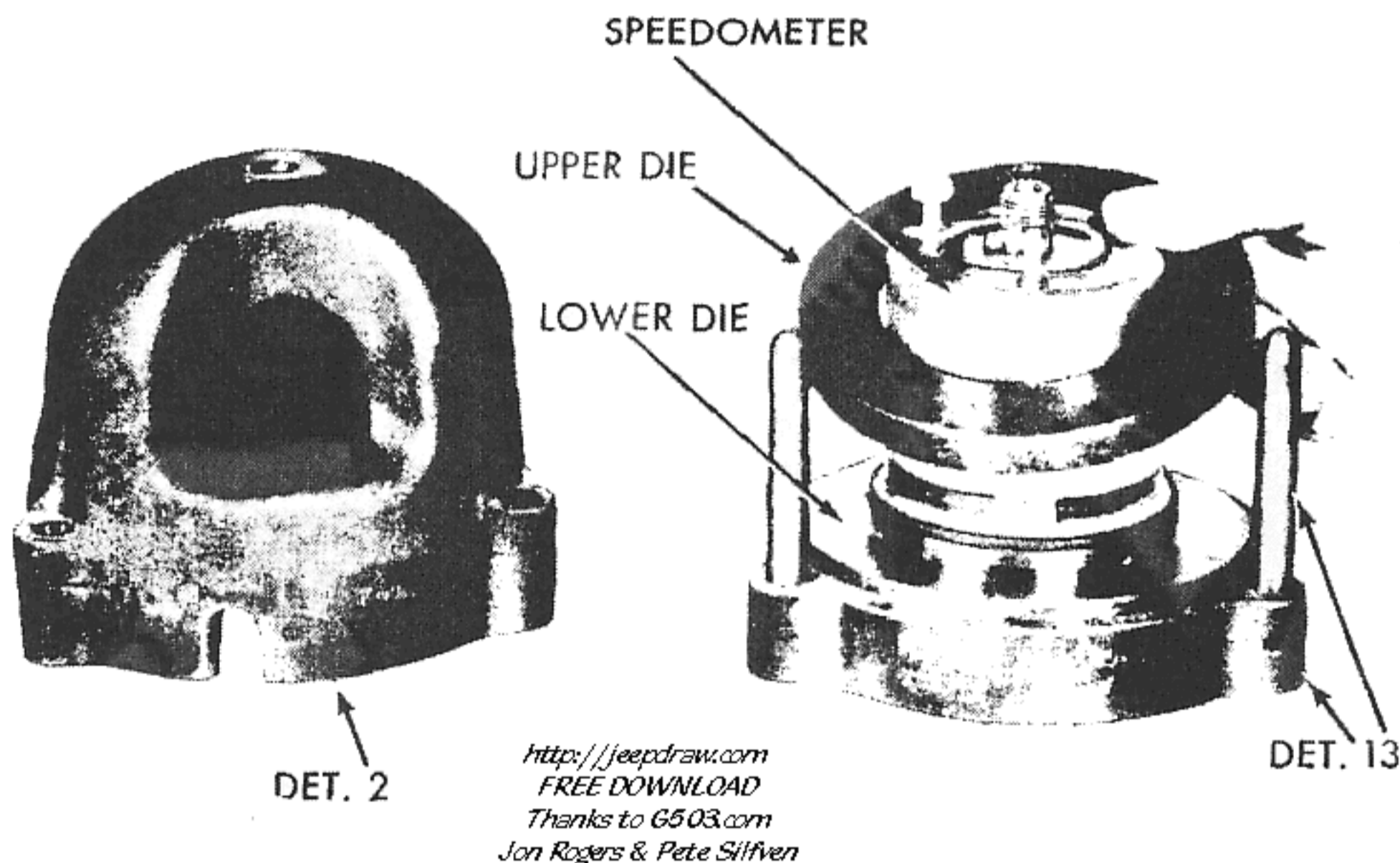

RA PD 318959

**Figure 74—Placing Upper Die of Bezel Rolling Fixture (T-178730) Over Speedometer**

ness. If this does not correct slowness, magnet is too weak and must be replaced. Run master at 10 miles per hour again and make any necessary minor corrections in instrument by moving hair spring regulator (fig. 59). Check instrument at all speeds. It should now read within following limits:

Master Reading	Calibration Tolerances
10 mph . . . . .	9-11 mph
30 mph . . . . .	30-32 mph
60 mph . . . . .	60-63 mph

If instrument cannot be calibrated, refer to paragraph 4.



**ORDNANCE MAINTENANCE  
SPEEDOMETERS, TACHOMETERS, AND RECORDERS**

m. **Replace Dial and Pointer.** Place dial onto mechanism and fasten to front jewel bracket with two screws. Start pointer on shaft at about  $\frac{1}{3}$  maximum dial indication, and carefully press it on while turning it counterclockwise to zero.

n. **Replace Bezel, Gaskets, Glass, etc.**

(1) **CRIMPED BEZEL.** Place instrument on surface that will not mar finish, and crimp bezel at several points with flat-end punch.

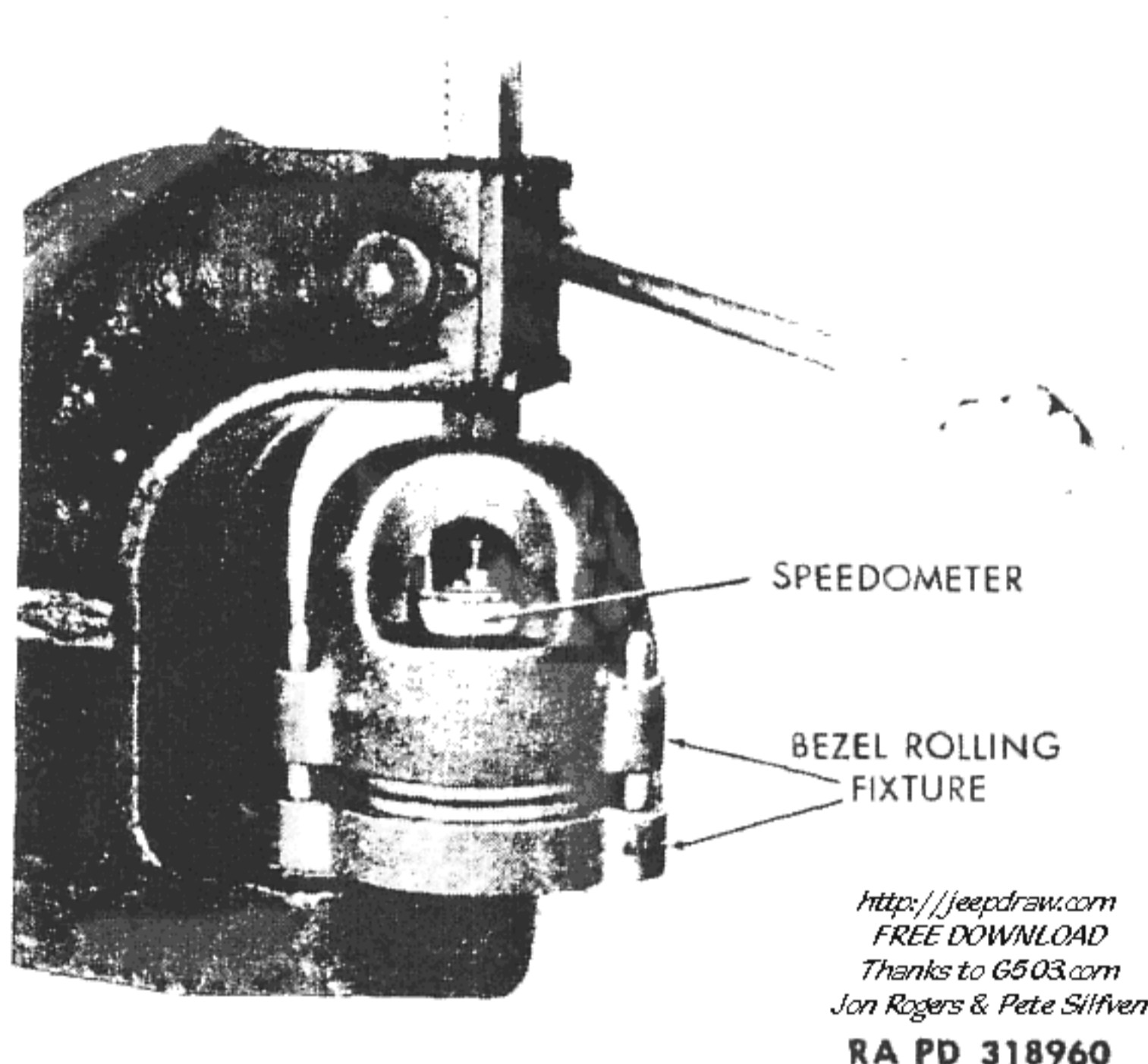

**Figure 75—Rolling Bezel with Fixture (T-178730) in Arbor Press**

(2) **ROLLED BEZEL.** Place lower die on base of bezel rolling fixture (T-178730 Det 13), place speedometer assembly face down on lower die, and place upper die over speedometer (fig. 74). Place upper portion of fixture (T-178730 Det 2) over speedometer, place entire assembly in arbor press, and roll bezel (fig. 75). Remove speedometer from tool.

(3) Attach miscellaneous parts to speedometer, such as reset shaft nut, reset knob, sealing gasket and plate, mounting bracket, etc.

## CHAPTER 6

### STEWART-WARNER SPEEDOMETERS AND TACHOMETERS (Cont'd)

#### Section II

#### SPEEDOMETERS AND TACHOMETERS WITH FLAT DISK-TYPE MAGNETS\*

*http://jeepdraw.com*  
*FREE DOWNLOAD*  
*Thanks to G503.com*  
*Jon Rogers & Pete Silfven*

### 32. DESCRIPTION.

a. This type instrument (fig. 76) operates on same principles as all other makes and types of magnetic units. However, it can readily be identified by the flat disk-type magnet and the main frame (fig. 89). For complete description, operation, and test procedure refer to paragraphs 2 and 4.

### 33. DISASSEMBLY.

a. **Remove Bezel and Glass.** The method used to remove bezel depends on whether it is a rolled, crimped or "pressed-on" bezel.

(1) **REMOVING ROLLED BEZEL.** Pry bezel loose (with screwdriver) at two points about  $\frac{1}{2}$  inch apart. Use cutting pliers and tear out this section of bezel (fig. 51), and pull bezel off (fig. 52).

(2) **REMOVING CRIMPED BEZEL.** Pry bezel up at crimped points (using screwdriver) and pull it off.

(3) **REMOVING "PRESSED-ON" BEZEL.** Remove mounting flange (if used). Using bezel remover (T-42358) drive bezel off (fig. 77).

b. **Remove Pointer and Face Dial.** On instruments where dial reads clockwise, remove pointer by grasping hub between thumb and forefinger and twisting gently in counterclockwise direction (against stop), at the same time pulling pointer outward carefully (fig. 78). On instruments where dial reads counterclockwise, remove pointer in same manner, as above, except twist in clockwise direction. Remove face dial screws and lift off face dial. **NOTE:** *On some models the face dial is held in place by lugs or ears (instead of screws) which must be straightened out before the face dial can be removed.*

c. **Remove Elbow Joint and Case.** Some instruments of this type have an elbow joint which must be removed by removing screw (fig. 79) before case can be removed. Then remove two case screws at rear of unit and lift mechanism out of case. Using spanner wrench (T-49509) unscrew bevel gear and sleeve assembly from elbow joint (fig. 80).

d. **Remove Odometer Assemblies.** Remove three screws (fig. 99) and lift off complete odometer and frame assembly. This allows third gear (fig. 101) to be lifted out. Remove total odometer assembly by removing screw and clip (fig. 81), or by removing spring

\*Speedometer types 86, 96, 509, 529, 584, 585, 592, 596, 680, 696, 709, 809.  
Tachometer types 521, 522, 523, 557, 584, 598, 599, 702, 721, 722, 727, 733,  
751, 752, 757, 833, 851, 852.

**ORDNANCE MAINTENANCE  
SPEEDOMETERS, TACHOMETERS, AND RECORDERS**

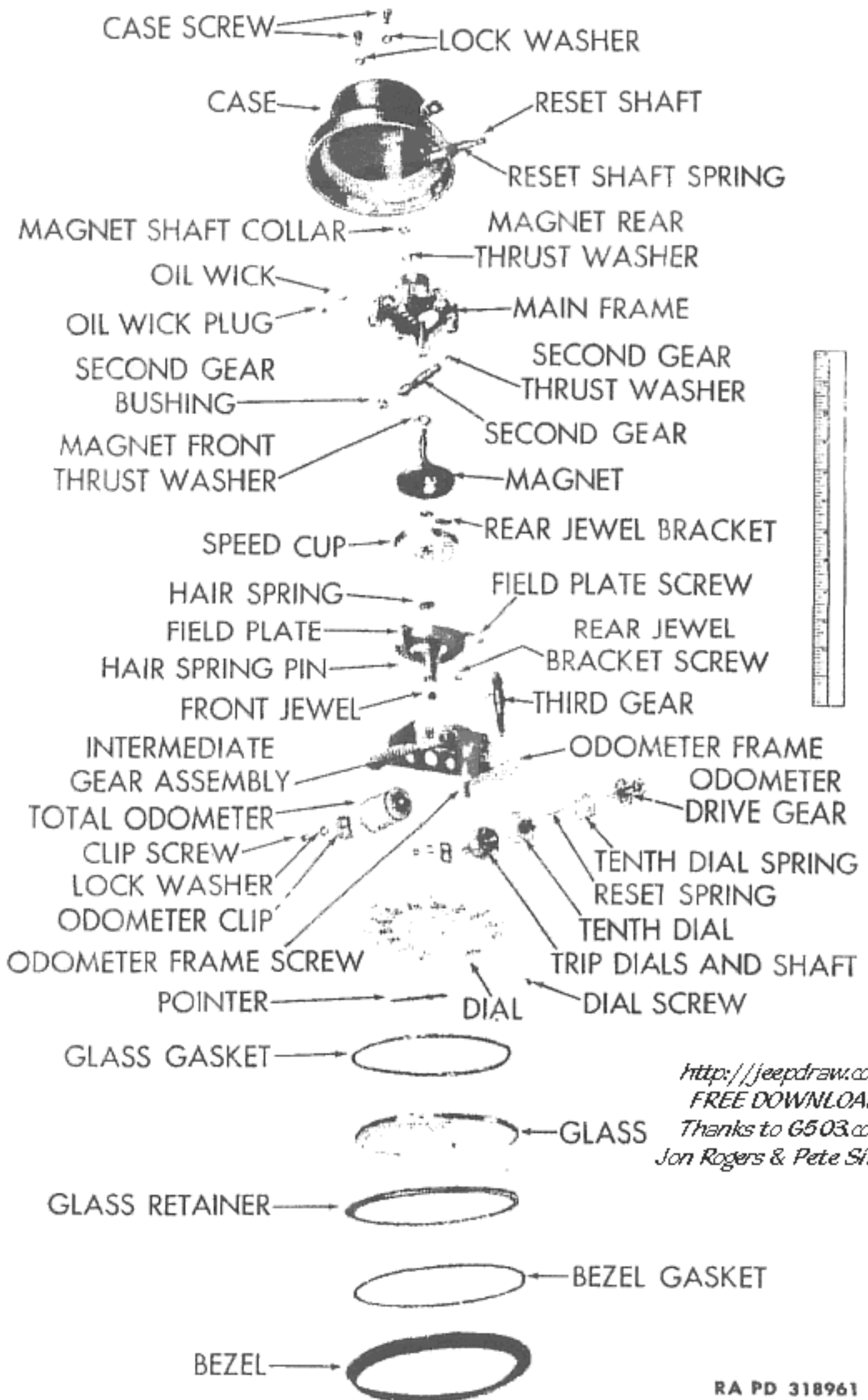

*http://jeepdraw.com  
FREE DOWNLOAD  
Thanks to G503.com  
Jon Rogers & Pete Silfven*

RA PD 318961

**Figure 76—Stewart-Warner Speedometer with Flat Disk-type Magnet Disassembled**

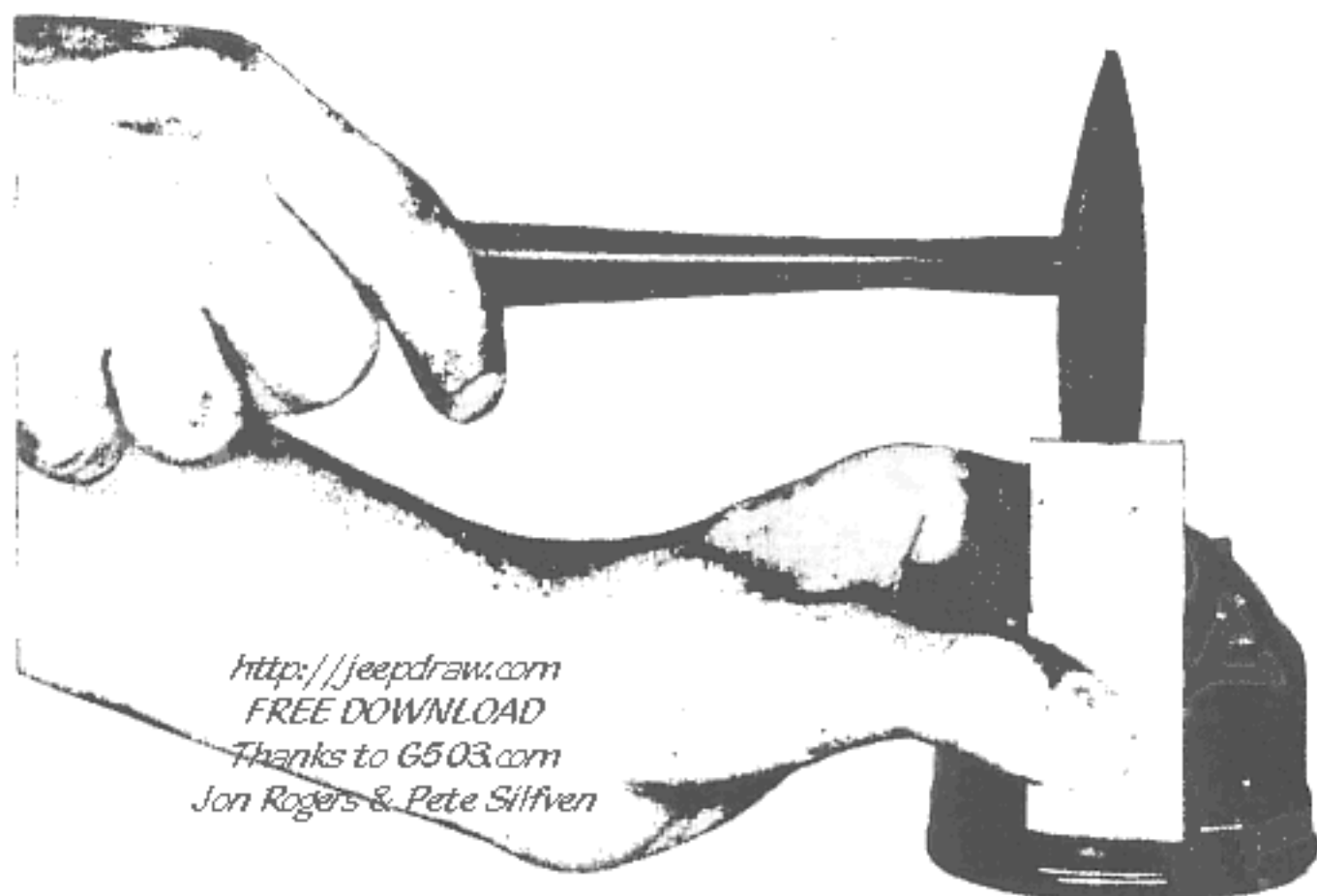
**SPEEDOMETERS AND TACHOMETERS WITH FLAT DISK-TYPE  
MAGNETS**

RA PD 318962

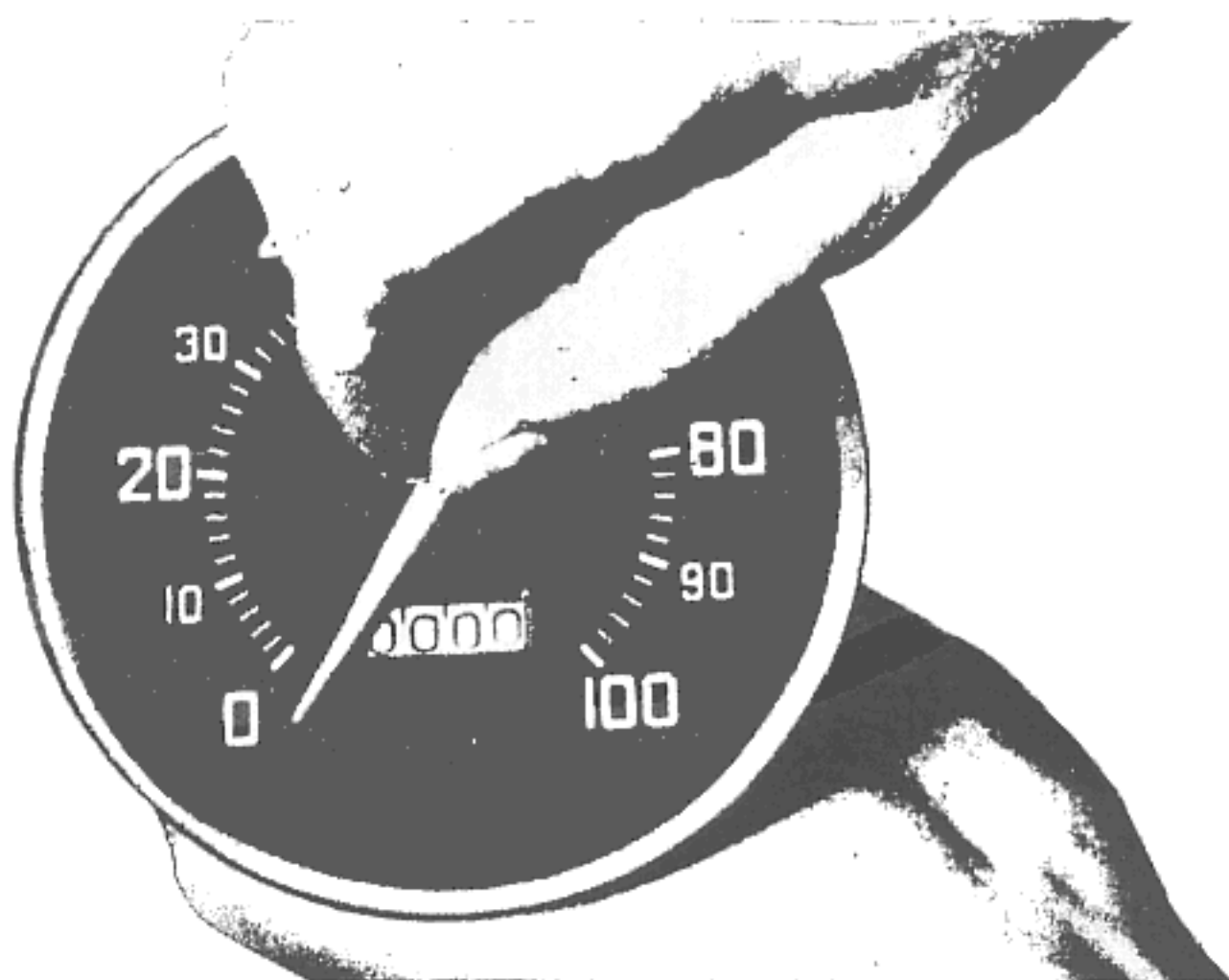
**Figure 77—Driving Off Pressed-on Bezel, Using Remover  
(T-42358)**

RA PD 318963

**Figure 78—Removing Pointer**

**ORDNANCE MAINTENANCE  
SPEEDOMETERS, TACHOMETERS, AND RECORDERS**

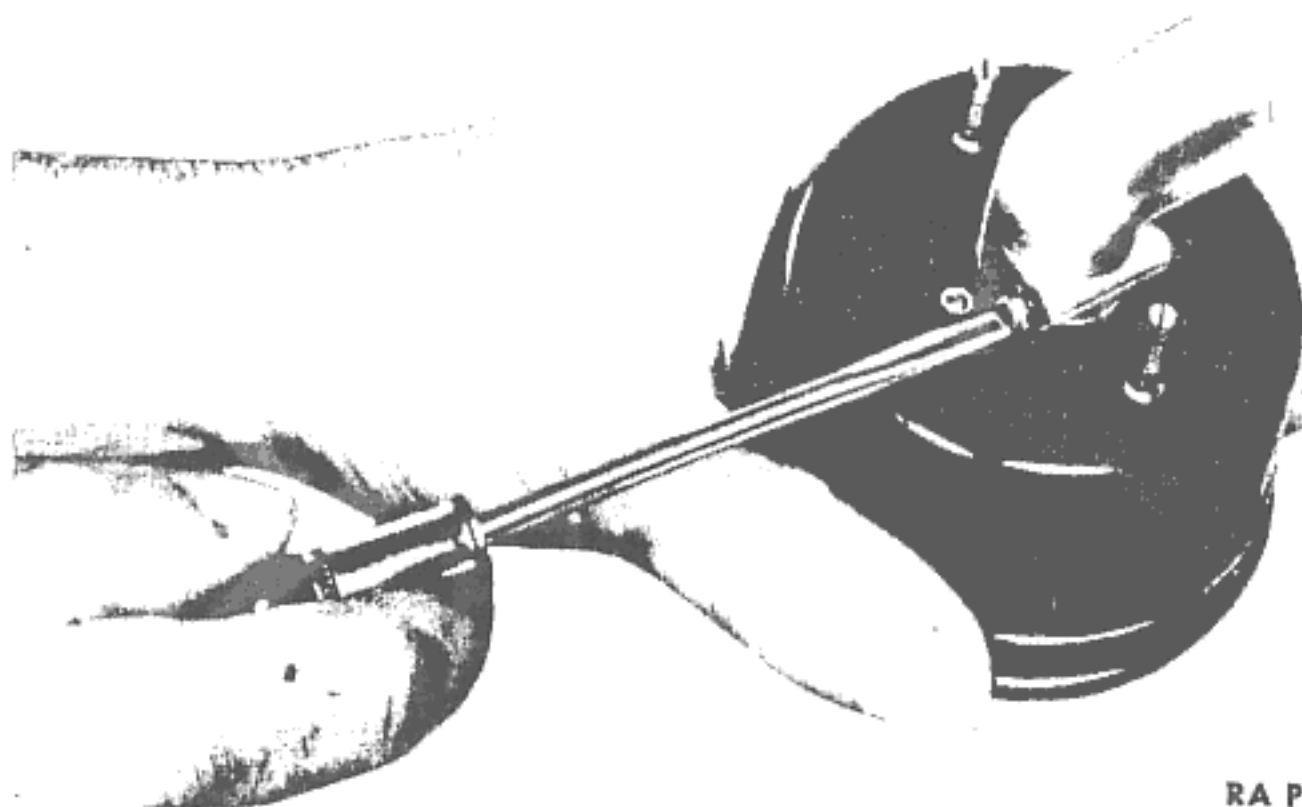

RA PD 318964

**Figure 79—Removing Elbow Joint Screw**

*http://jeepdraw.com  
FREE DOWNLOAD  
Thanks to G503.com  
Jon Rogers & Pete Silfven*

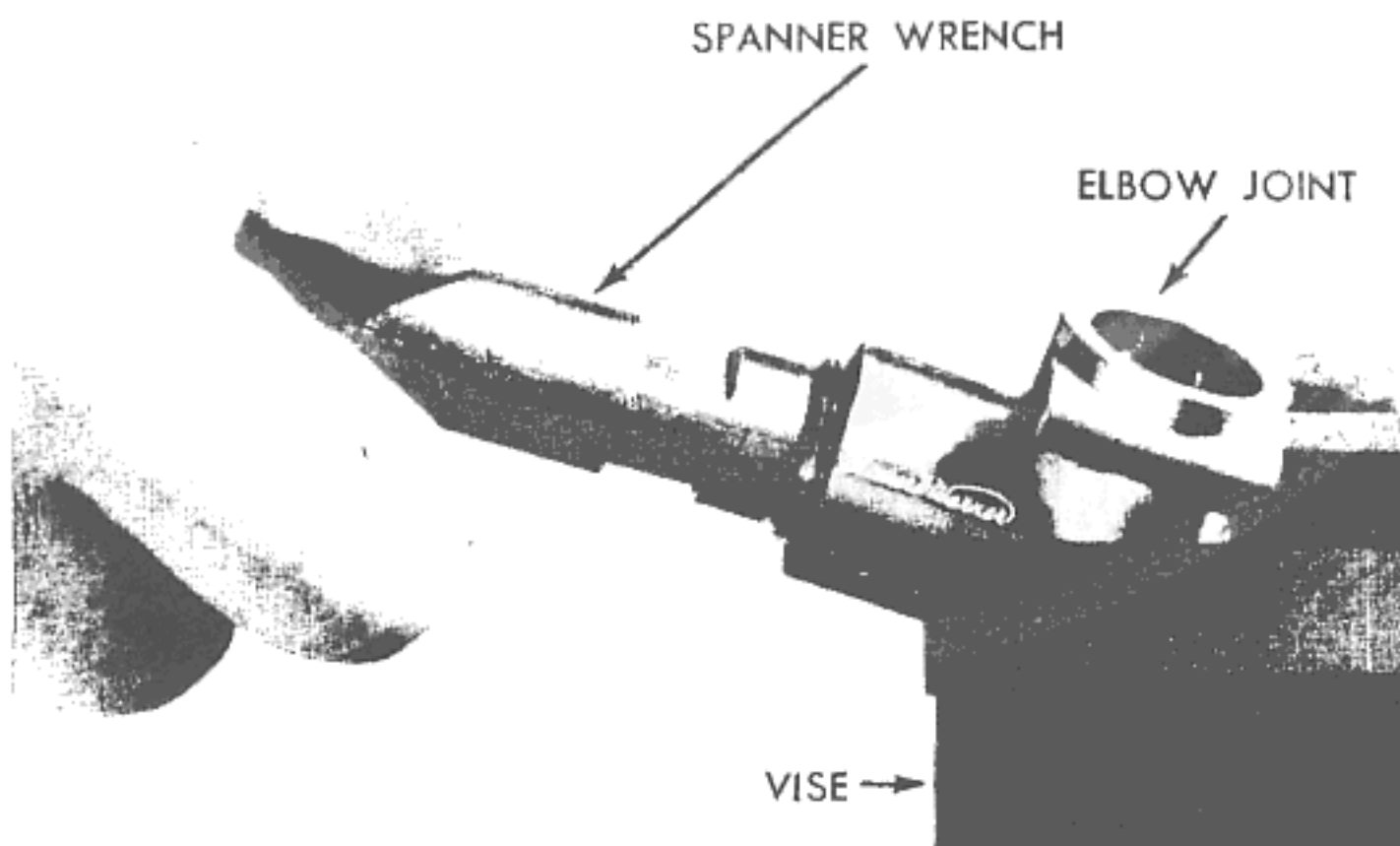

RA PD 318965

**Figure 80—Removing Bevel Gear and Sleeve Assembly,  
Using Spanner Wrench (T-49509)**

## SPEEDOMETERS AND TACHOMETERS WITH FLAT DISK-TYPE MAGNETS

clip (fig. 99), depending upon type of odometer retainer used on instrument being disassembled. Remove trip odometer clip (fig. 81) and lift out trip dials and shaft assembly, tenth dial, dial spring, reset spring, and drive gear (fig. 100).

e. **Remove Odometer Intermediate Gear.** It is necessary to remove this gear only when it is to be replaced. Drill out crimping at center of spur gear (fig. 82), and punch out drive gear.

f. **Remove and Disassemble Speed Unit.** Remove three field plate screws (fig. 83) and lift off speed unit. Remove two screws (fig. 83) and lift out rear jewel bracket. Place one jaw of long-nosed pliers against shoulder that holds hair spring pin and other jaw of pliers against small end of pin and squeeze pin out (fig. 97). The end of the hair spring will then be free allowing speed cup and staff to be

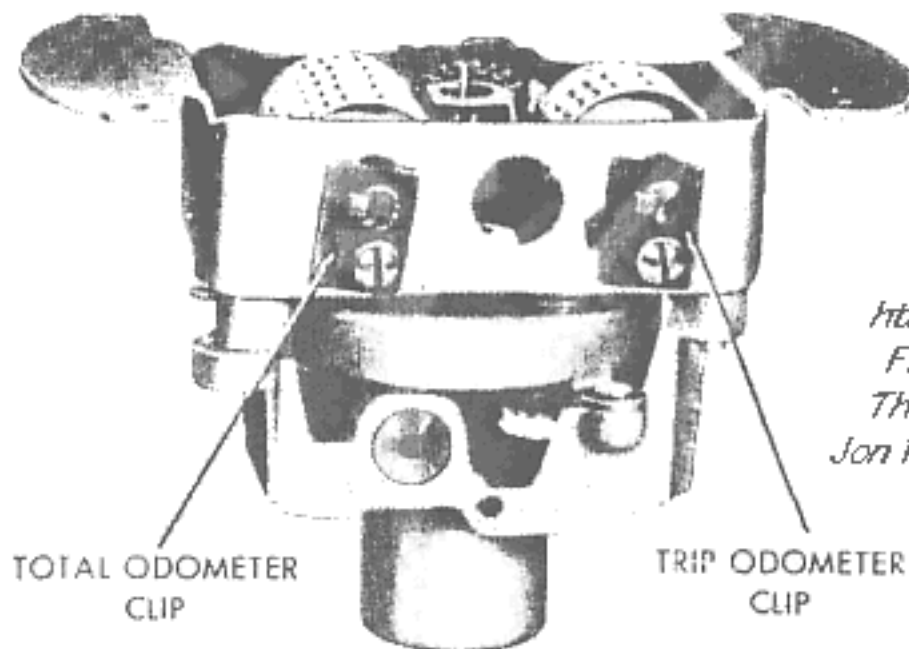

*http://jeepdraw.com  
FREE DOWNLOAD  
Thanks to G503.com  
Jon Rogers & Pete Silfven*

RA PD 318966

**Figure 81—Speedometer Mechanism (Dial Removed)**

removed. Using adjuster (T-178705) unscrew front jewel (fig. 96). Back off thumb screw of hair spring puller (T-66296) and place claw around staff and under center of hair spring. Tighten down thumb screw until hair spring comes off (fig. 84).

g. **Remove Second Gear.** Place frame, gear, and magnet assembly in vise (not too tightly). Using punch, drive on end of second gear (fig. 85) until brass bushing at other end of shaft drops out.

h. **Remove Magnet (Including First Gear).** The second gear must be removed before the magnet can be removed. The method of removing the magnet from the frame depends upon whether the magnet is held in place with a brass collar, or with a bevel gear on the end of the magnet shaft. The bevel gear is used only on units having the elbow joint (fig. 79).

(1) **REMOVING MAGNET RETAINED BY BRASS COLLAR.** Assemble body of magnet disassembly wrench (T-170654) to threaded neck of

**ORDNANCE MAINTENANCE  
SPEEDOMETERS, TACHOMETERS, AND RECORDERS**

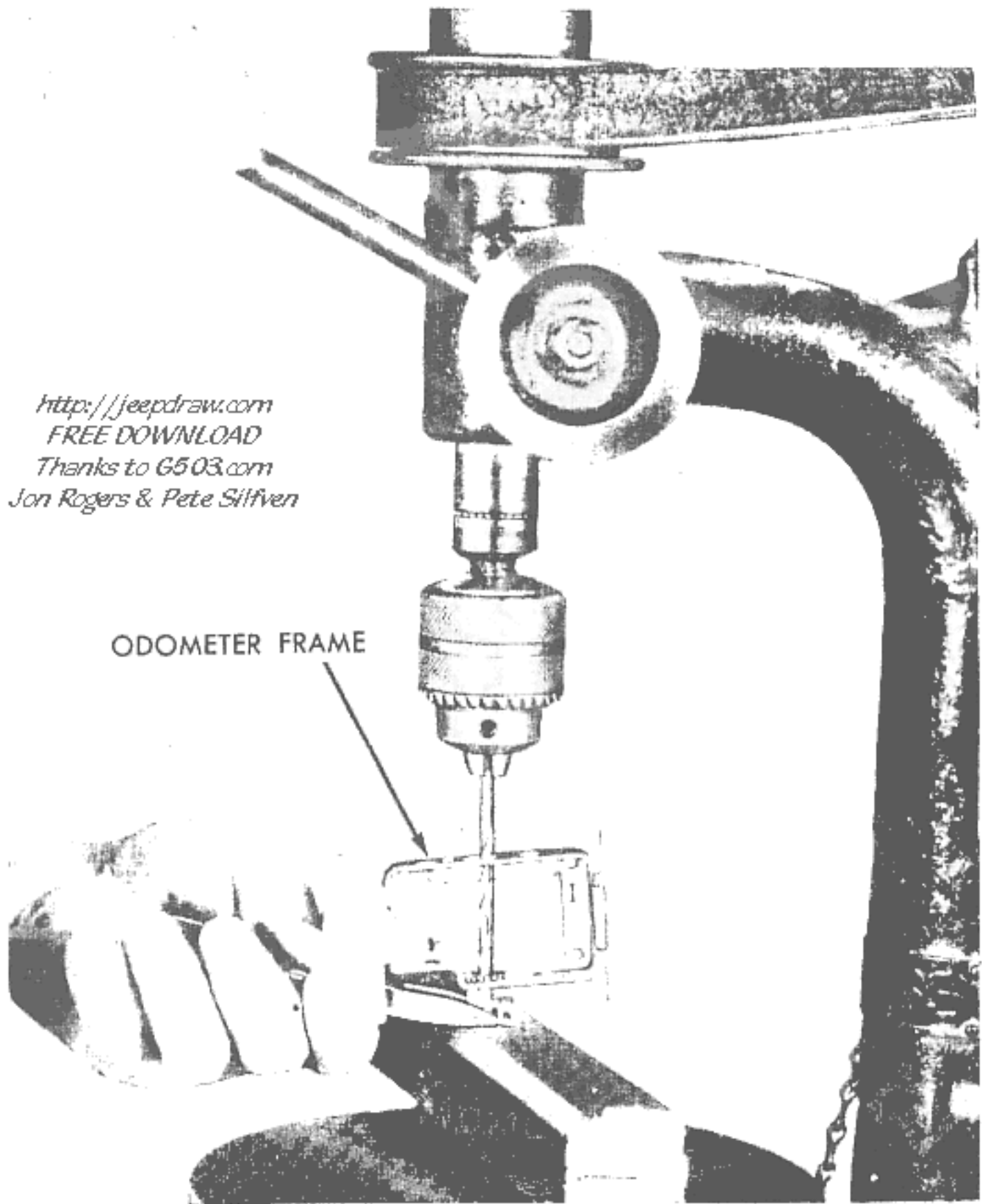

*http://jeepdraw.com*  
*FREE DOWNLOAD*  
*Thanks to G503.com*  
*Jon Rogers & Pete Silfven*

ODOMETER FRAME

RA PD 318967

**Figure 82—Drilling Out Crimping at Center of Spur Gear**

frame, backing off handle so that wrench body will tighten down snugly to frame. Then turn wrench handle clockwise (fig. 86) until collar is pressed off the magnet shaft. Push magnet back to original position and remove collar and flat steel washer. Using fixture with adapter (T-170666 with Det 7) (fig. 87), tighten down handle to smooth out flare in magnet shaft. **CAUTION:** *Care must be taken when using fixture to make sure that it does not come in contact with steel portion of magnet, causing it to be weakened.* After smoothing

## SPEEDOMETERS AND TACHOMETERS WITH FLAT DISK-TYPE MAGNETS

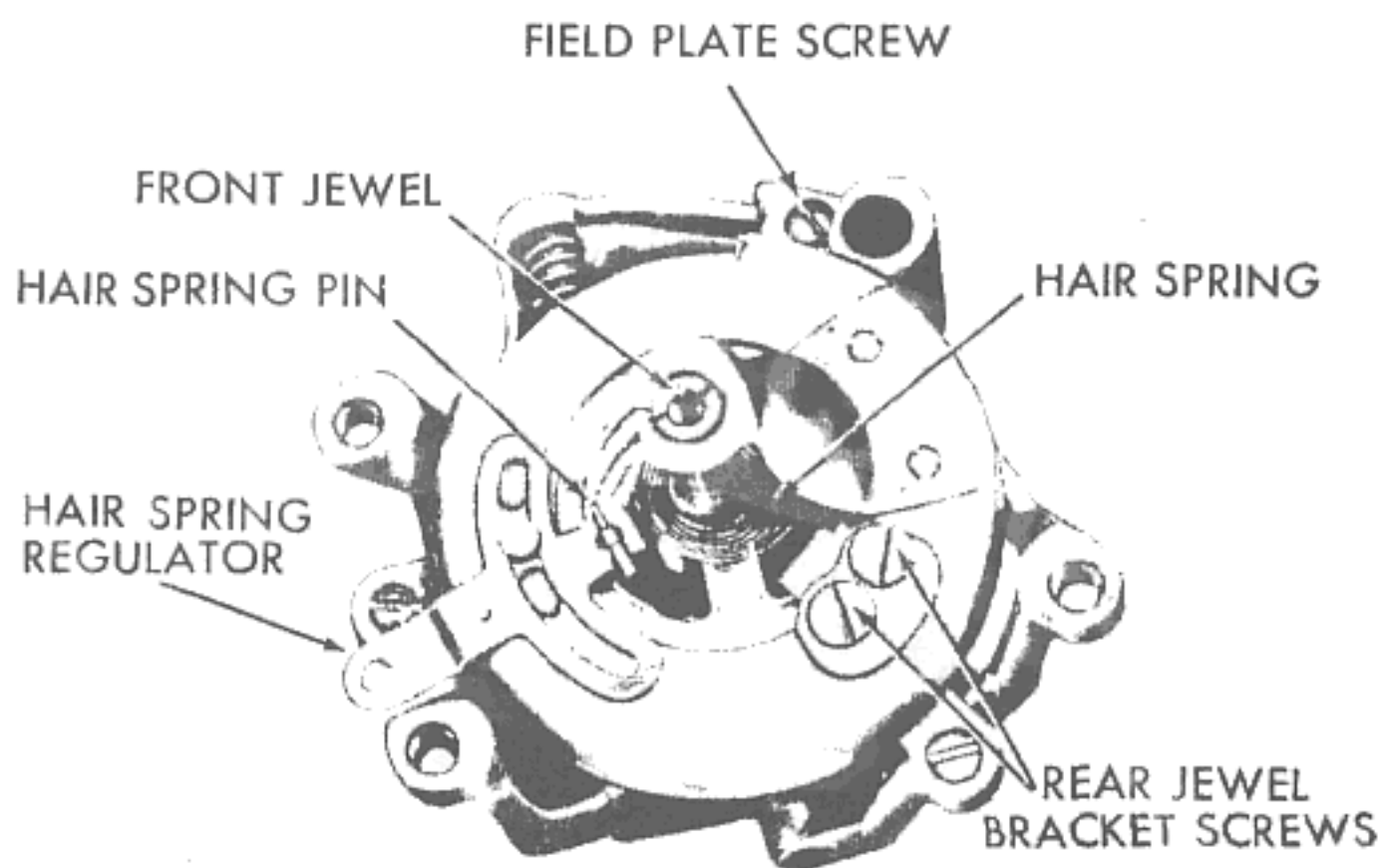

RA PD 318968

**Figure 83—Speedometer Mechanism (Odometer Frame Removed)**

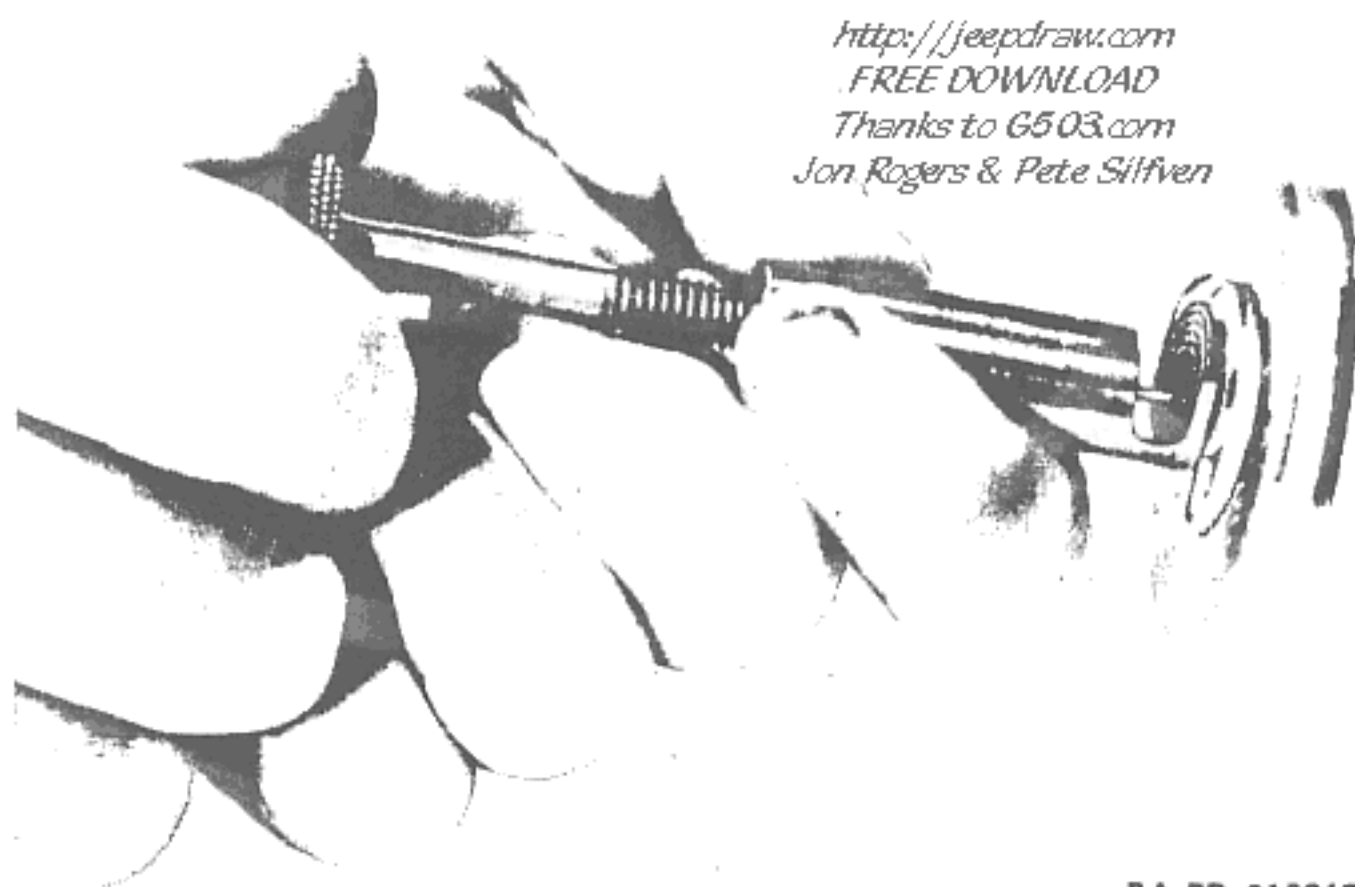

*http://jeepdraw.com*  
*FREE DOWNLOAD*  
*Thanks to G503.com*  
*Jon Rogers & Pete Silfven*

RA PD 318969

**Figure 84—Removing Hair Spring, Using Puller (T-66296)**



**ORDNANCE MAINTENANCE  
SPEEDOMETERS, TACHOMETERS, AND RECORDERS**

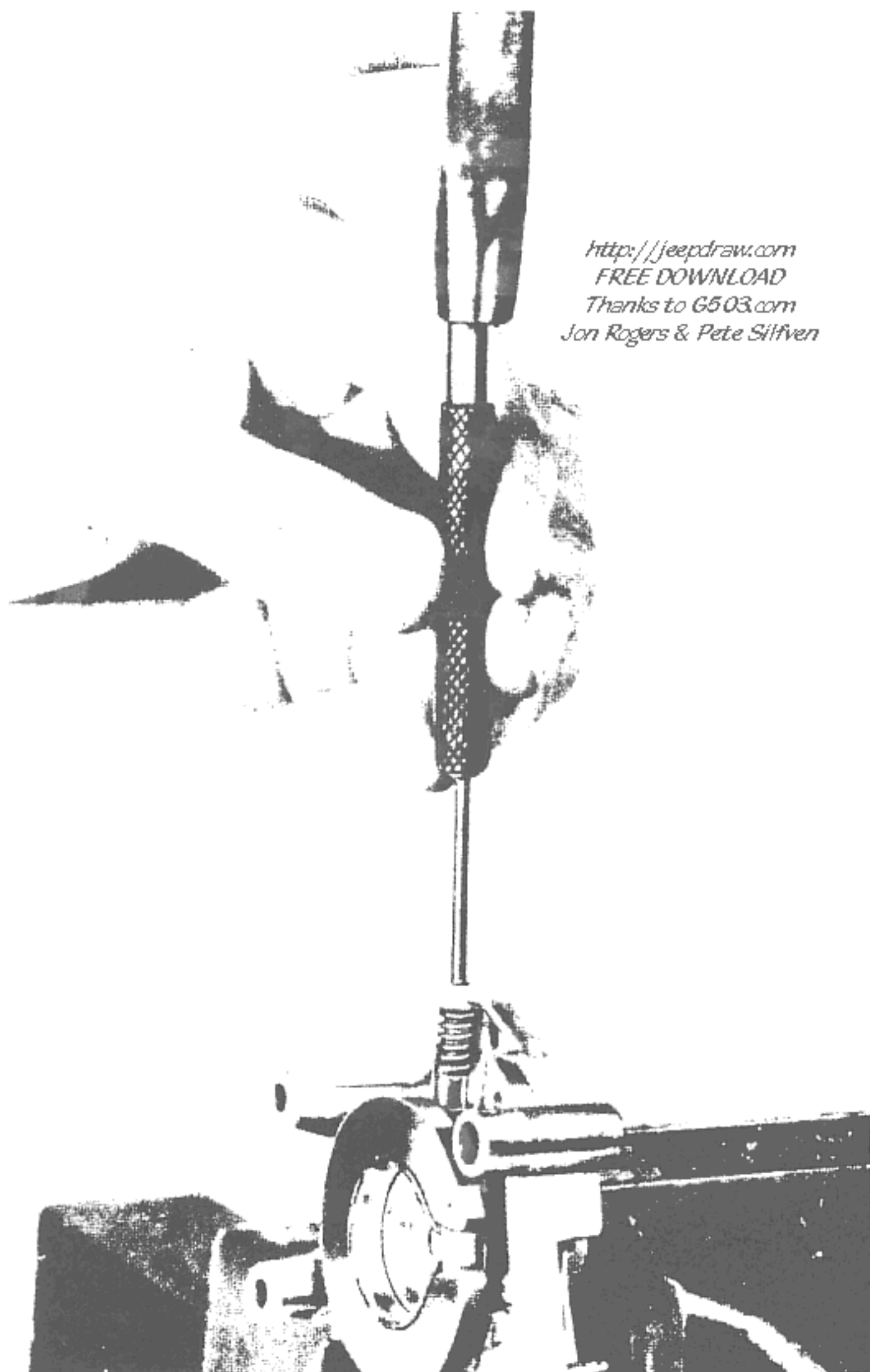

*http://jeepdraw.com  
FREE DOWNLOAD  
Thanks to G503.com  
Jon Rogers & Pete Silfven*

RA PD 318970

**Figure 85—Removing Second Gear**

## SPEEDOMETERS AND TACHOMETERS WITH FLAT DISK-TYPE MAGNETS

out flare, use safety-edge file (T-170757) to remove any remaining burs from end of magnet shaft (fig. 62) to prevent scoring bearing surface in frame, then slip magnet and shaft out of frame.

(2) **REMOVING MAGNET RETAINED BY BEVEL GEAR.** Place frame, gear and magnet assembly in vise (use brass jaws) and, using punch, drive out the magnet and shaft assembly (fig. 88). **NOTE:** *Both magnet and gear must be discarded after removal from frame.*

i. **Remove Oil Wick.** Using punch remove oil wick plug from frame (fig. 63). Then lift wick out of frame (using tweezers).

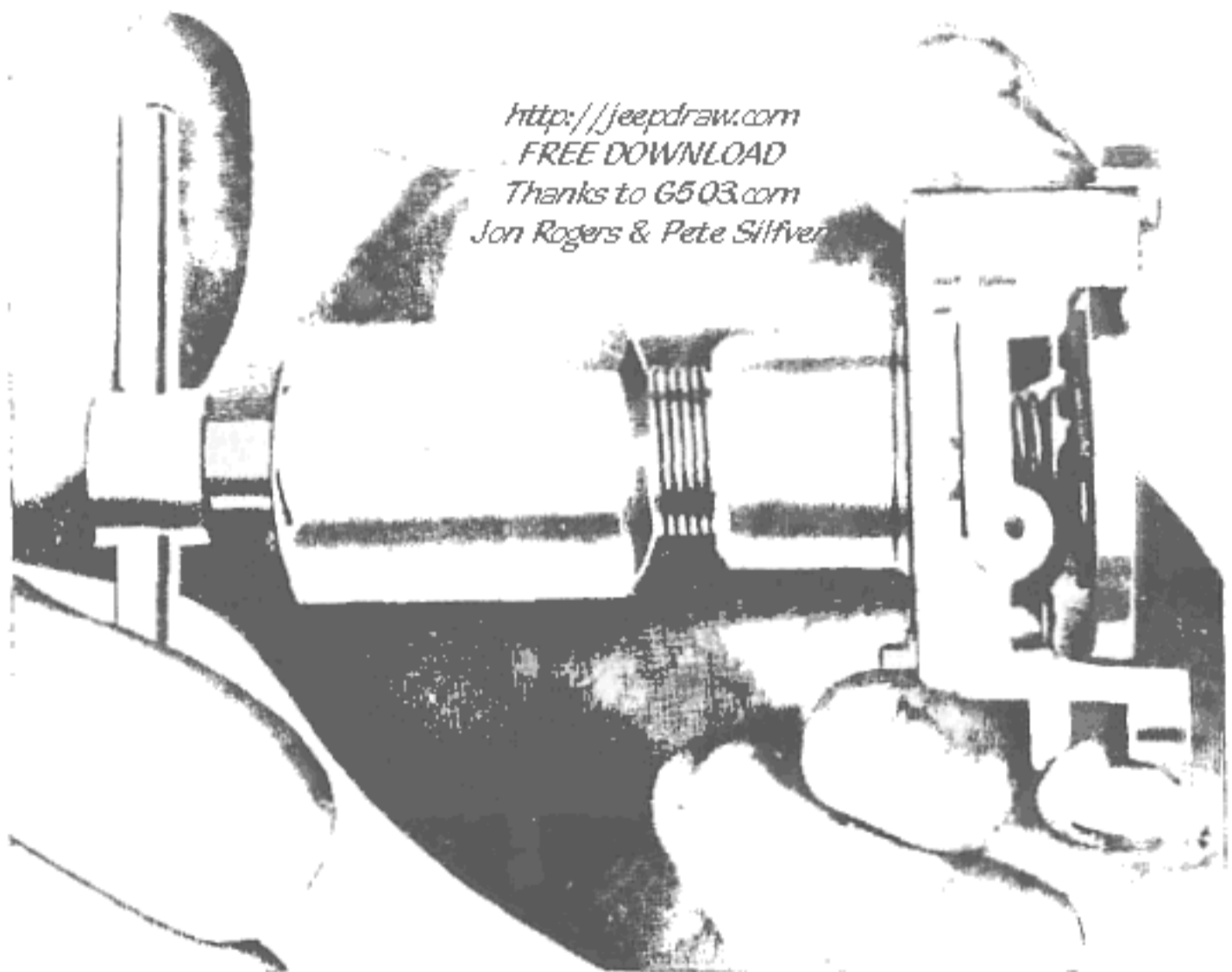

*http://jeepdraw.com  
FREE DOWNLOAD  
Thanks to G503.com  
Jon Rogers & Pete Silver*

RA PD 318971

**Figure 86—Removing Magnet Shaft Collar, Using Dismantling Wrench (T-170654)**

### 34. CLEANING, INSPECTION AND REPAIR OF PARTS.

a. **General.** The cleaning, inspection, and repair of these type instruments is the same as for Stewart-Warner speedometers with cup-type magnets (par. 30).

### 35. ASSEMBLY AND CALIBRATION.

a. **Replace Magnet.** Set magnet regulator (fig. 89) in center of gap. Lubricate first gear (on magnet shaft) with small amount of

## ORDNANCE MAINTENANCE SPEEDOMETERS, TACHOMETERS, AND RECORDERS

No. 00 Grease, O.D., and lubricate shaft with watch and clock oil. Place thrust washer (fig. 89) on main frame and then place magnet shaft in frame, making sure that thrust washer is in proper position. Place rear thrust washer and brass collar (or bevel gear) over end of shaft. Using magnet assembly fixture (T-170666 with Det 1) tighten down (figs. 90 and 91) until collar (or bevel gear) is pressed all the way onto shaft. **CAUTION:** *Care must be taken when using fixture to make sure that it does not come in contact with steel portion of magnet, causing it to be weakened.* Using fixture (T-170666 with Det 6), flare end of magnet shaft (fig. 92). Allow about 0.003-inch end play (barely perceptible) in magnet shaft. Check to see that magnet turns freely.

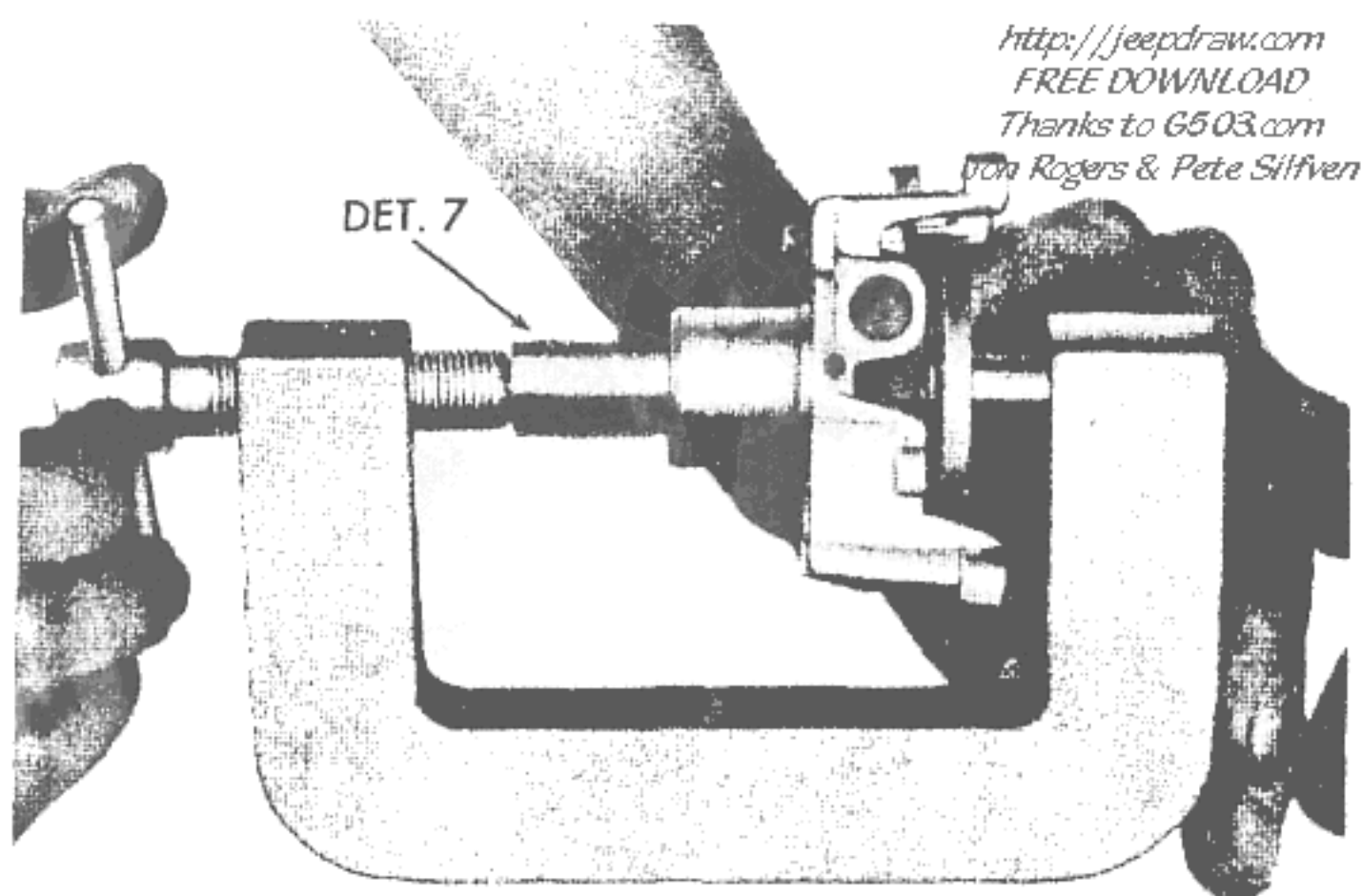

RA PD 318972

**Figure 87—Smoothing Out Flare in Magnet Shaft, Using  
Fixture (T-170666 with Det 7)**

**b. Replace Oil Wick and Plug.** Saturate oil wick in watch and clock oil and place in frame. Using punch, tap oil wick plug into place (fig. 67).

**c. Replace Second Gear.** Place frame and magnet assembly in vise (not too tightly) with opening for second gear bushing on top. Lubricate gear teeth with small amount of No. 00 Grease, O.D. Do not overlubricate. Place tiny brass thrust washer over lower end of second gear and place in frame. Drive brass bushing into place (fig. 93) allowing about 0.003-inch end play. Test for free turning.

**d. Test Magnet Strength to Determine Proper Hair Spring.** Place hair spring selector (408164) on frame and magnet assembly.

## SPEEDOMETERS AND TACHOMETERS WITH FLAT DISK-TYPE MAGNETS

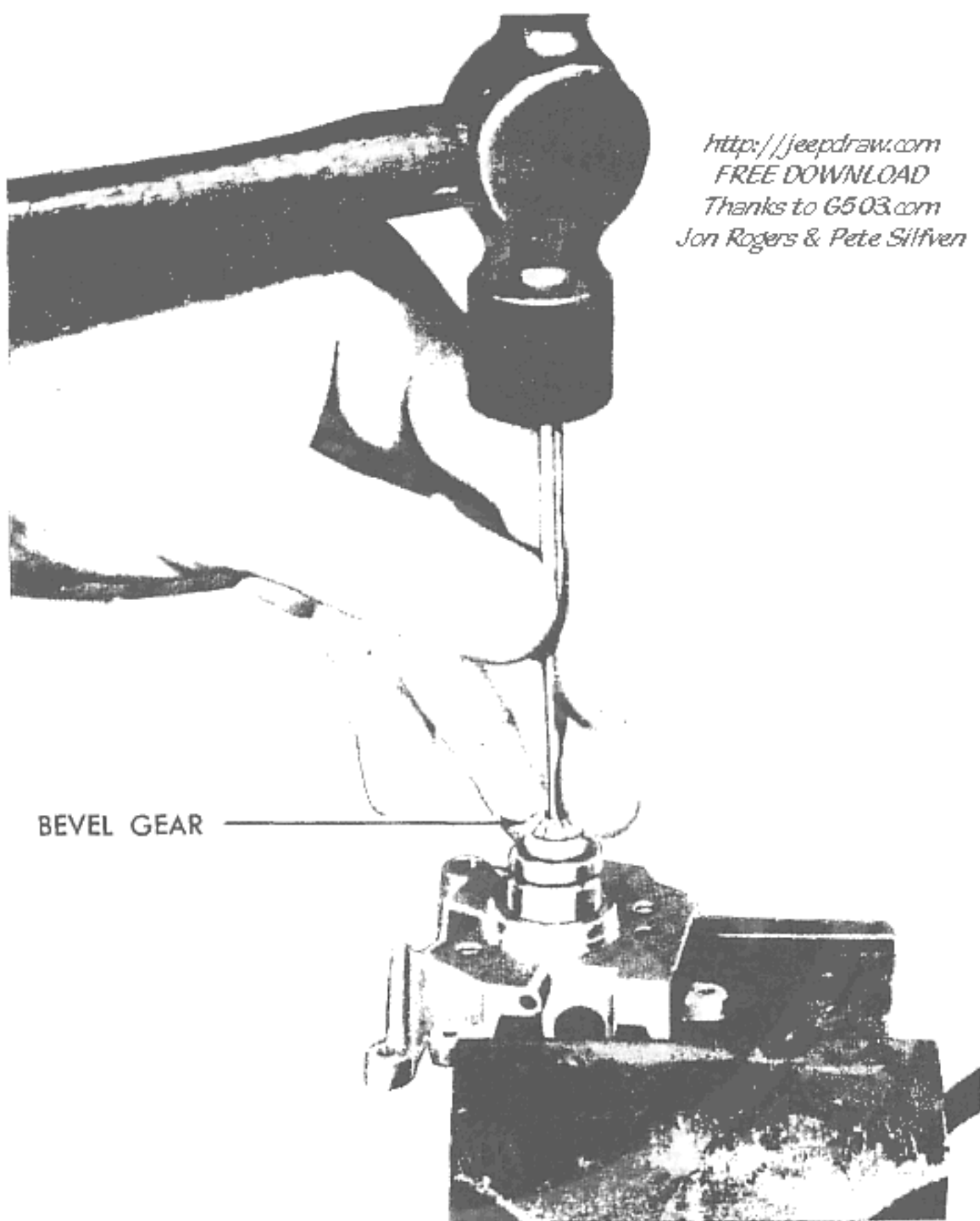

RA PD 318973

**Figure 88—Driving Out Magnet Retained by Bevel Gear**

Place assembly on calibrating machine (fig. 94) and run master at 60 miles per hour (chapter 13). The reading obtained from the hair spring selector can be converted to hair spring tension (in degrees) by referring to "Hair Spring Chart" (par. 31 f) after determining pointer deflection (in degrees) at 60 miles per hour of speedometer being repaired (see following list). Select proper hair spring from kit (408082).

**ORDNANCE MAINTENANCE  
SPEEDOMETERS, TACHOMETERS, AND RECORDERS**

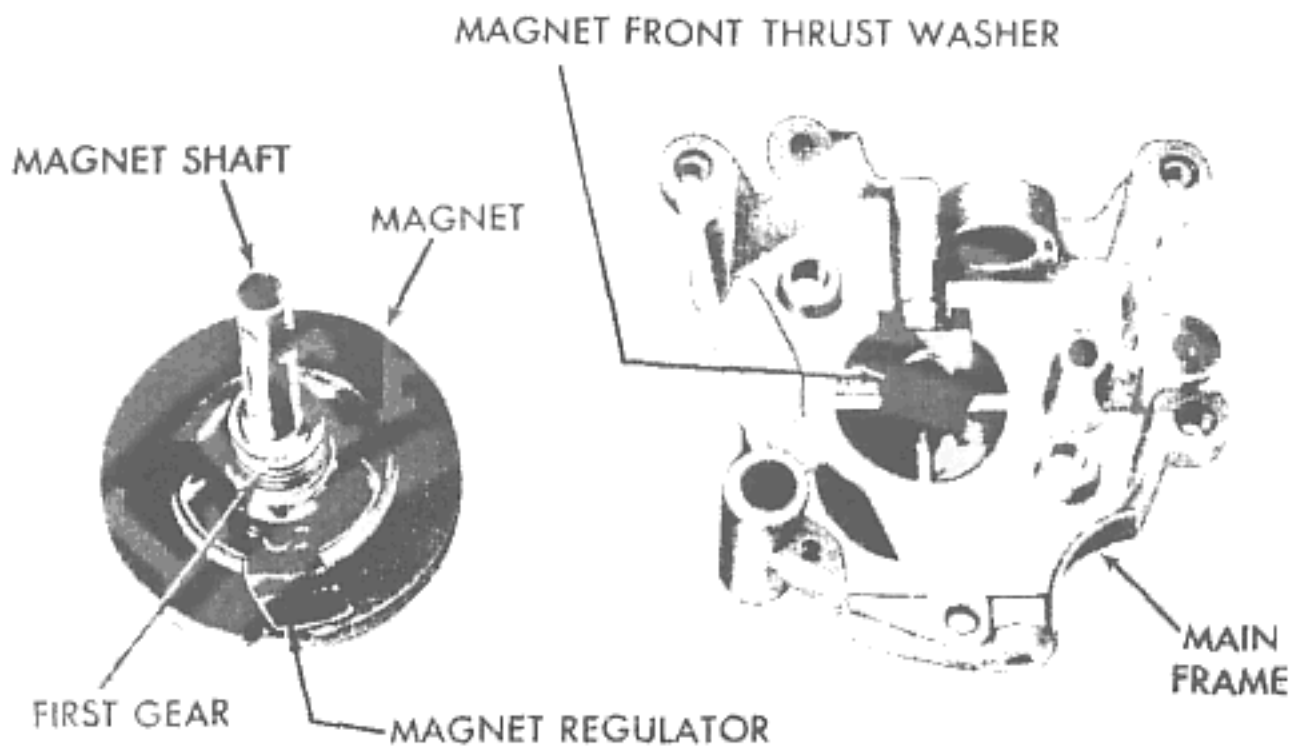

RA PD 318974

**Figure 89—Magnet Removed from Frame**

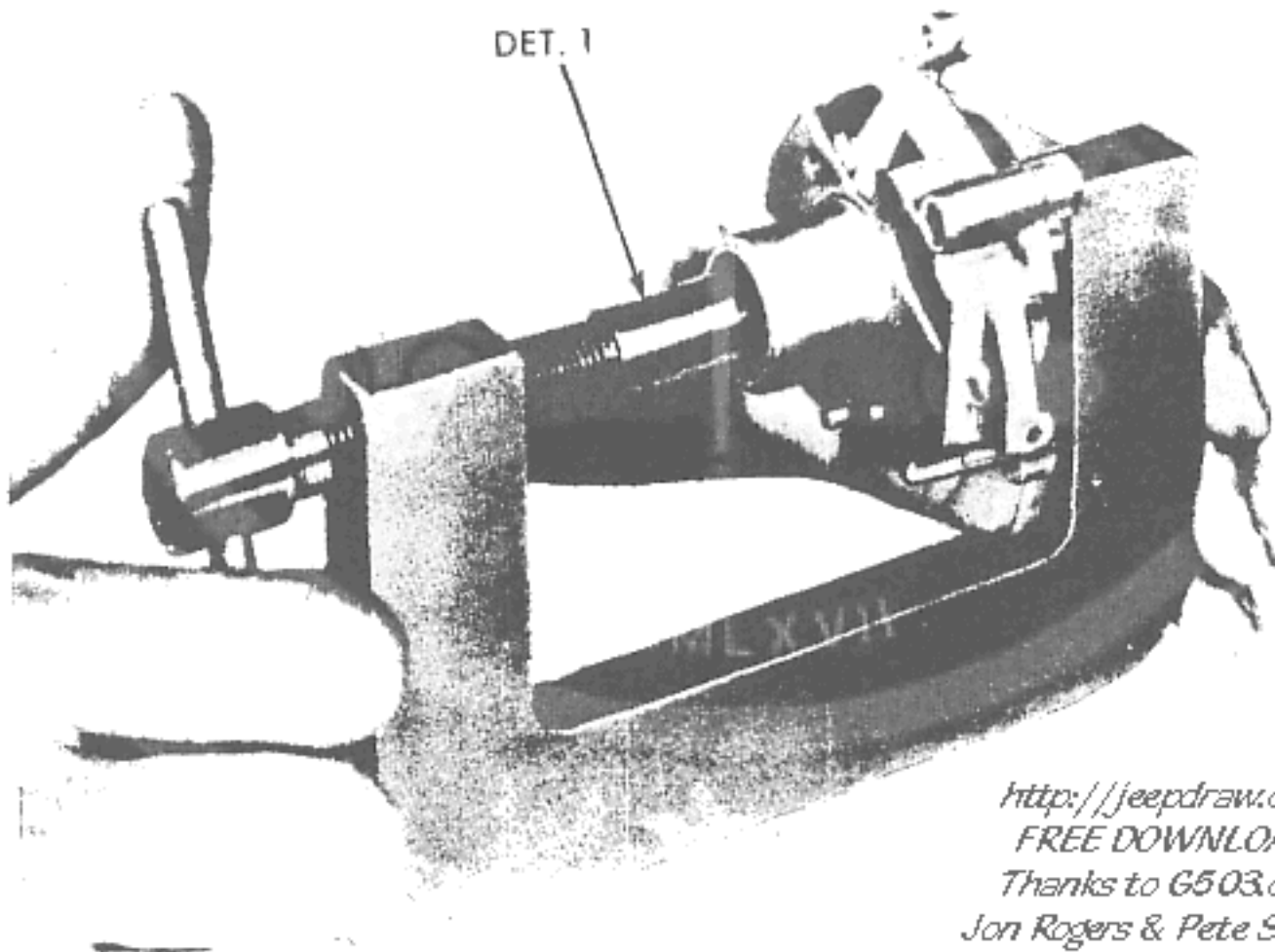

*http://jeepdraw.com  
FREE DOWNLOAD  
Thanks to G503.com  
Jon Rogers & Pete Silfven*

RA PD 318975

**Figure 90—Pressing Collar on Magnet Shaft, Using Fixture  
(T-170666 with Det 1)**

**SPEEDOMETERS AND TACHOMETERS WITH FLAT DISK-TYPE MAGNETS**

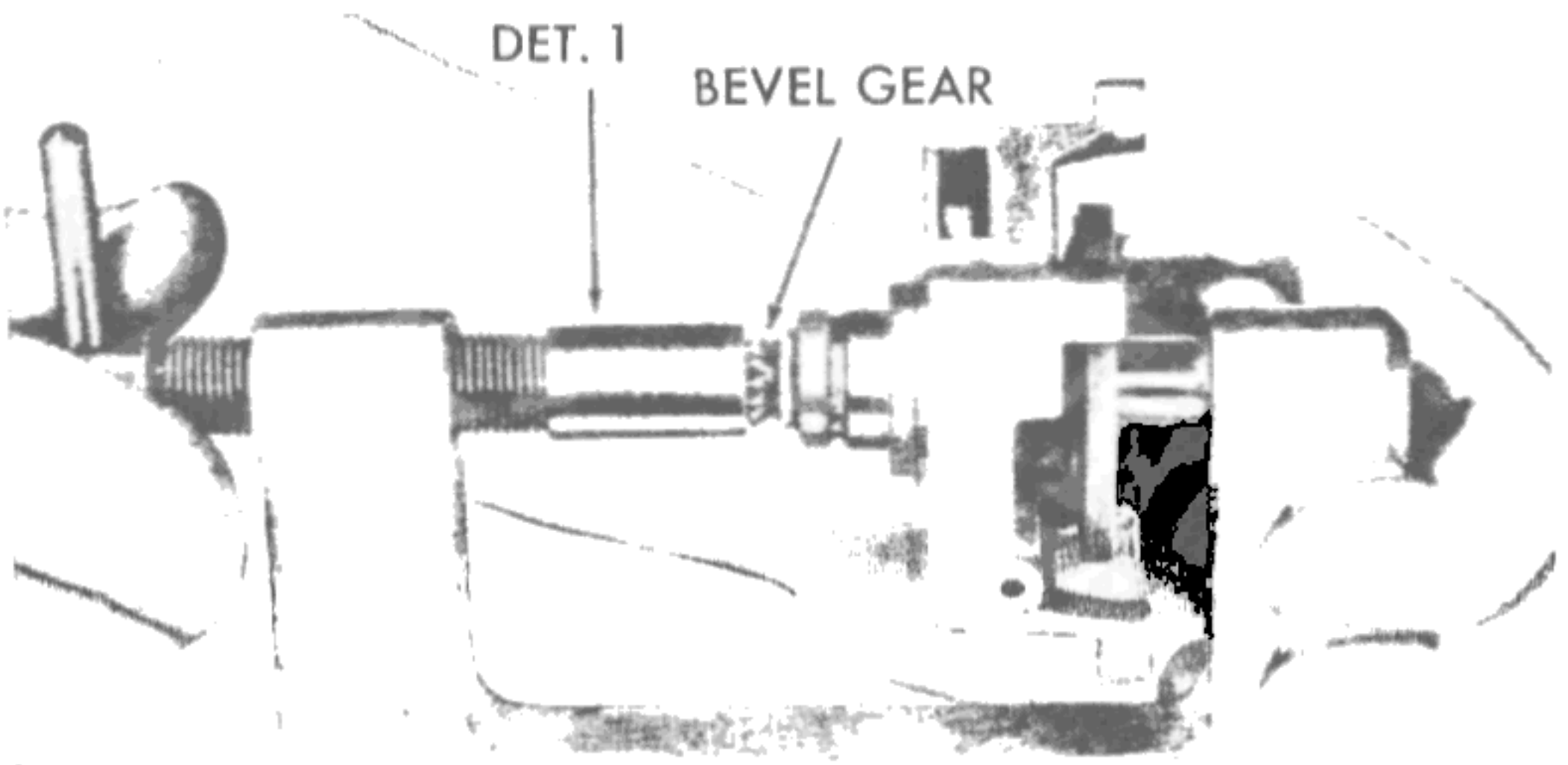

*http://jeepdraw.com  
 FREE DOWNLOAD  
 Thanks to G503.com  
 Jon Rogers & Pete Silfven*

RA PD 318976

**Figure 91—Pressing Bevel Gear on Magnet Shaft, Using Fixture (T-170666 with Det 1)**

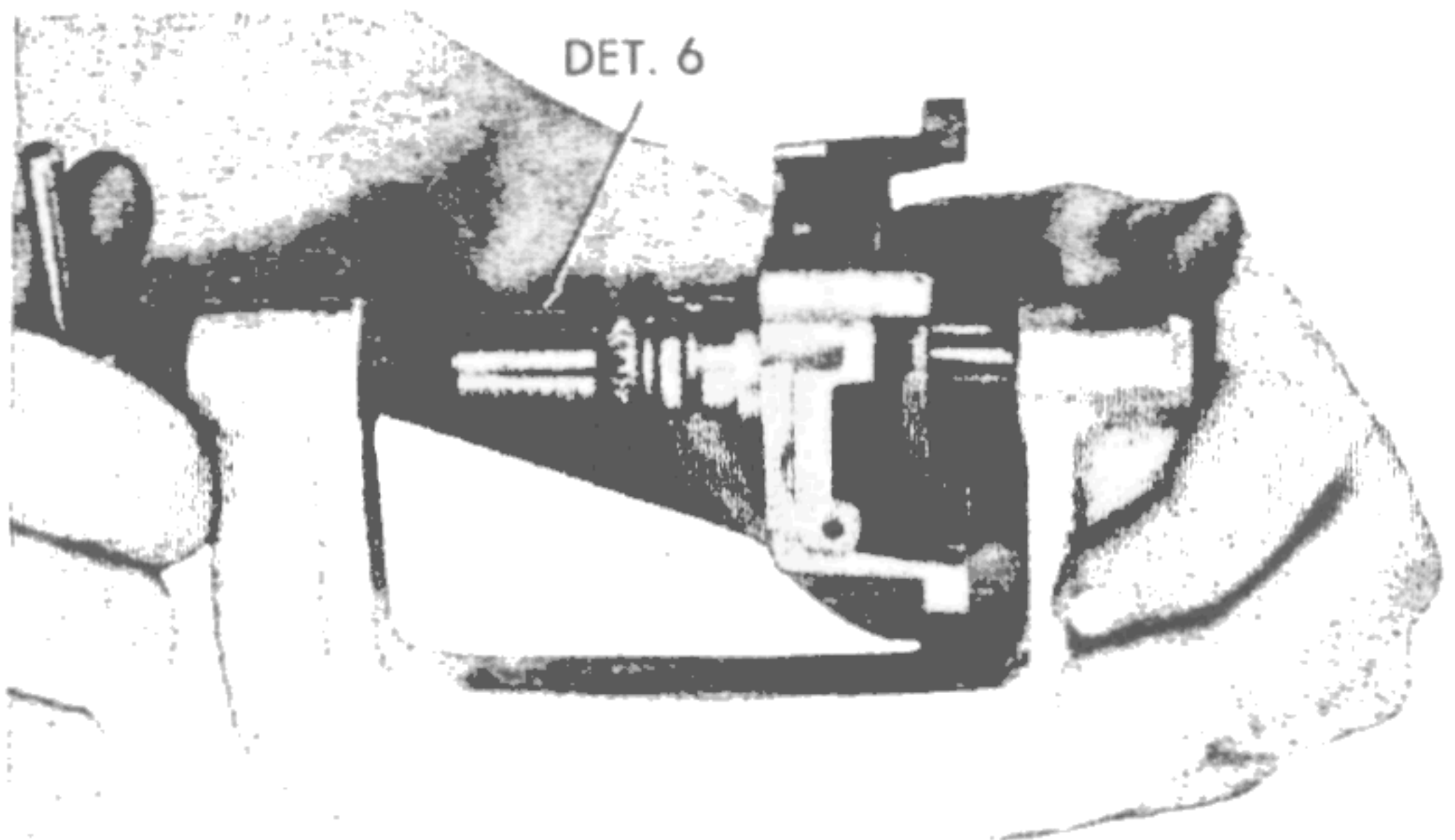

RA PD 318977

**Figure 92—Flaring Magnet Shaft, Using Fixture (T-170666 with Det 6)**

ORDNANCE MAINTENANCE  
SPEEDOMETERS, TACHOMETERS, AND RECORDERS

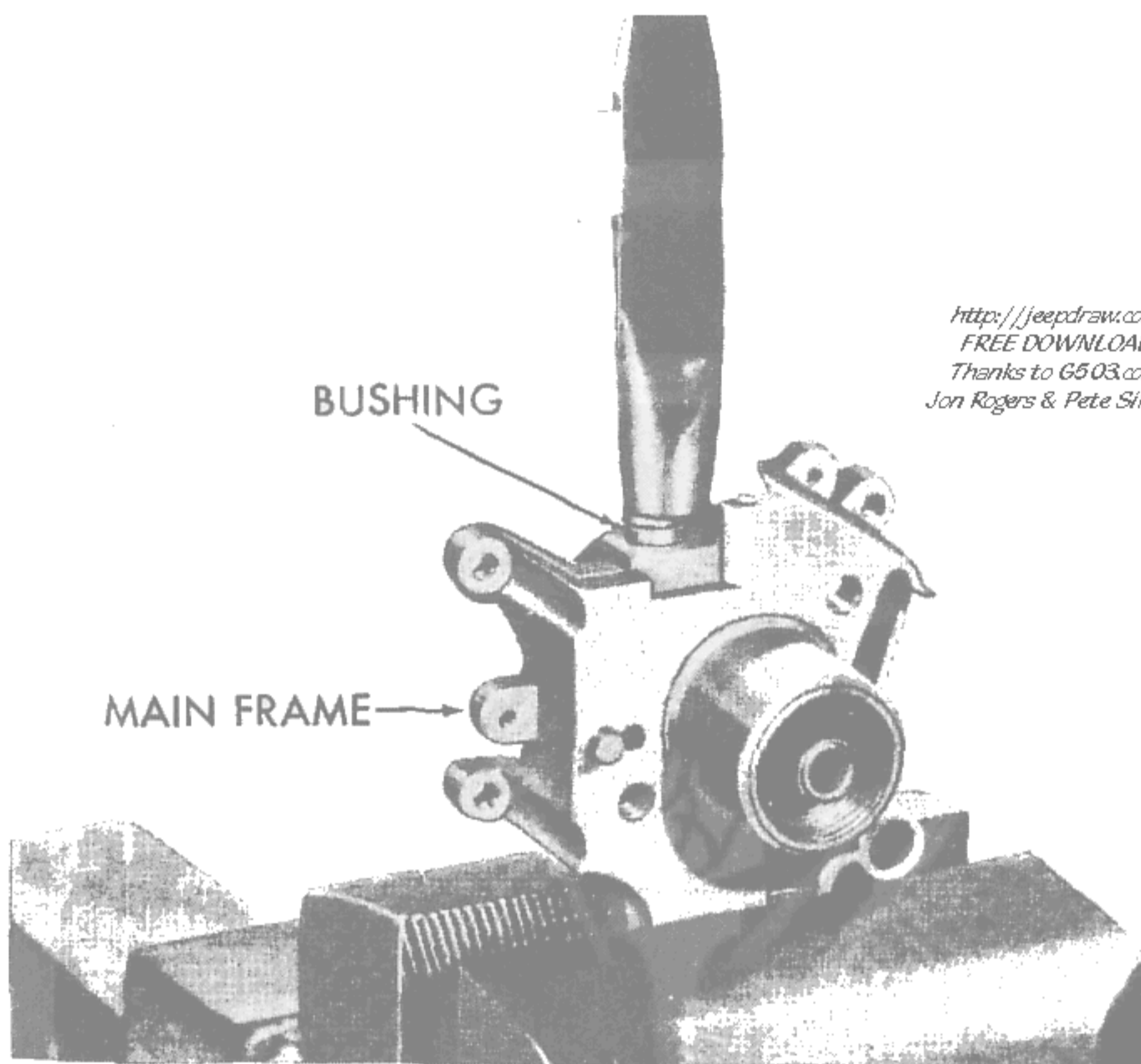

RA PD 31897B

**Figure 93—Driving Second Gear Bushing in Place**

Speedometer Model No.	*Pointer Deflection (in degrees) at 60 mph (1,000 rpm)	Speedometer Model No.	*Pointer Deflection (in degrees) at 60 mph (1,000 rpm)
509-DZ	235	529-CC	141
509-EA	141	529-CD	205
509-EB	113	529-CJ	140
529-Y	170	529-CL	205
529-AJ	205	584-F	207
529-AL	210	584-AM	205
529-BG	168	585-AL	205
529-BH	205	585-AM	197
529-BR	197	595-AX	161
529-BX	113	585-BE	205
529-BY	205	596-BP	183
529-CA	197	596-BS	199

\*As the position of the numerals on the dial vary a great deal on different model speedometers, it is necessary to take this fact into consideration when selecting the proper hair spring to go with each magnet. Therefore, the above list is provided showing the angle

## SPEEDOMETERS AND TACHOMETERS WITH FLAT DISK-TYPE MAGNETS

(measured in degrees) that the pointer travels between zero dial reading and 60 miles per hour dial reading. If the model number of the speedometer being repaired does not appear in above list, the angle of pointer travel from zero to 60 miles per hour on the dial may be easily determined with a protractor.

e. **Assemble Speed Unit.** Place speed cup on anvil of hair spring assembly fixture (T-29 Det 5). Place hair spring over end of staff with loose end pointing counterclockwise, if instrument has clockwise face dial. If instrument has counterclockwise face dial, then the

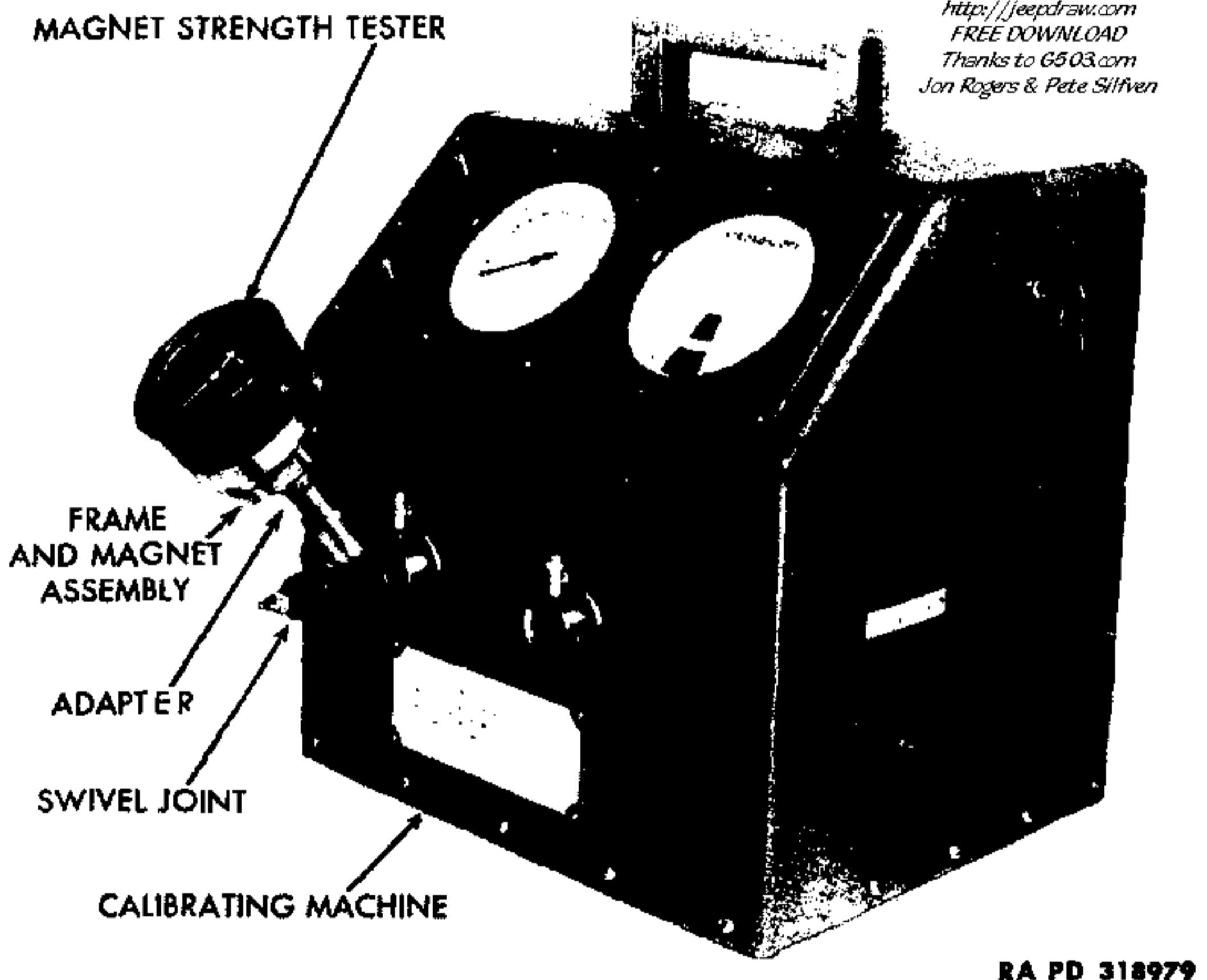

RA PD 318979

**Figure 94—Magnet Strength Tester (408164) (on Frame and Magnet Assembly) Attached to Calibrating Machine (T-170645)**

loose end of the hair spring should point in a clockwise direction. Using female punch (T-29 Det 2), carefully drive hair spring on staff leaving about  $\frac{1}{8}$  inch clearance between hair spring collet and speed cup (fig. 95). Place speed cup and hair spring assembly inside field plate and install rear jewel bracket (two screws). Using adjuster (T-178705), replace front jewel and adjust (fig. 96) to about 0.003-inch end play in pointer staff. Insert end of hair spring in slot in hair spring regulator with end of spring protruding through slot about  $\frac{1}{8}$  inch. Using long-nosed pliers, squeeze pin tightly in posi-



**ORDNANCE MAINTENANCE  
SPEEDOMETERS, TACHOMETERS, AND RECORDERS**

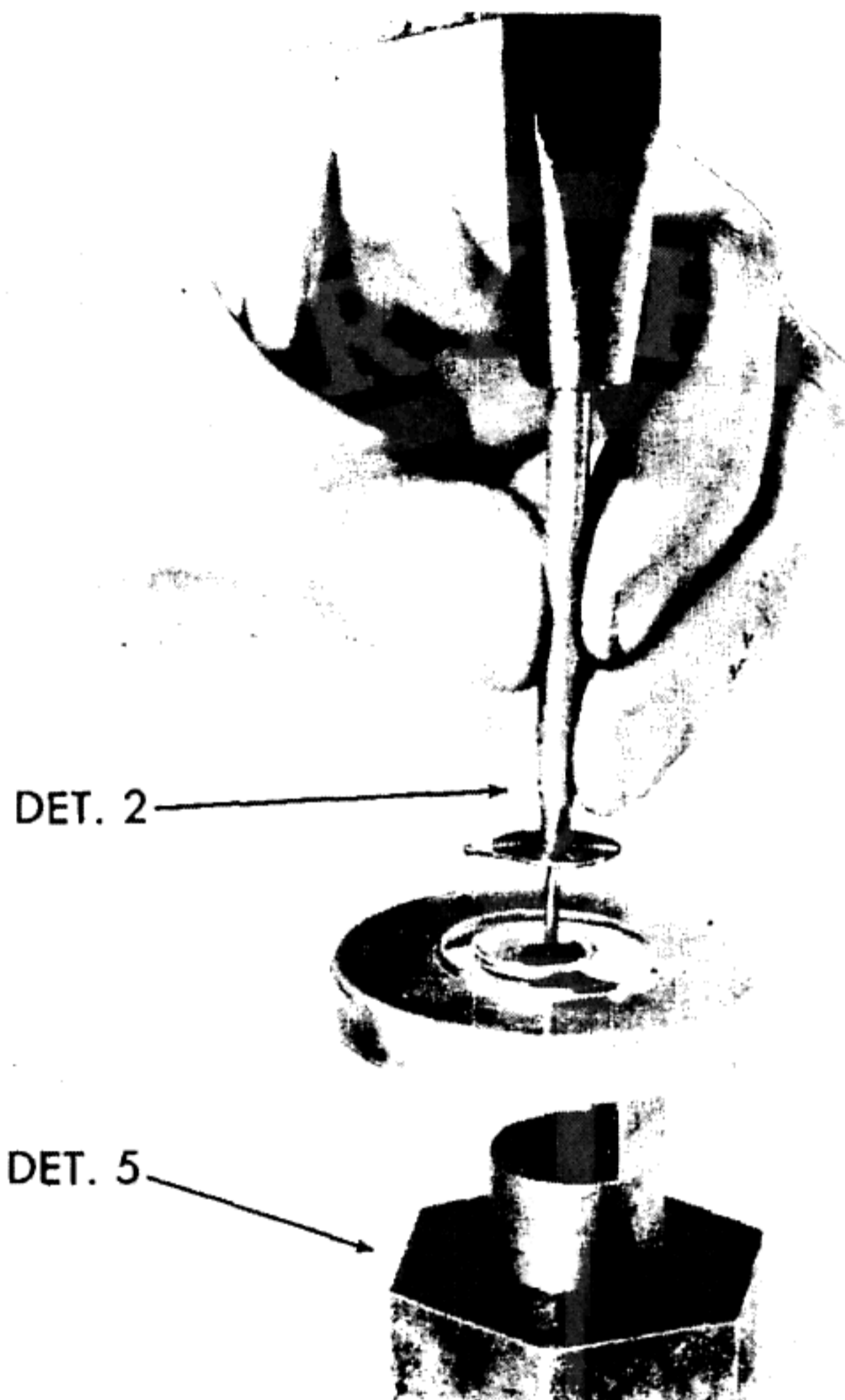

RA PD 318980

**Figure 95—Replacing Hair Spring, Using Assembly Kit (T-29)**

tion (fig. 97) with small end of pin pointing in the opposite direction to which the end of hair spring is pointing. Using adjuster (T-51742), turn hair spring collet on staff (fig. 72) until speed cup stop rests against rear jewel bracket and so that hair spring tends to pull speed cup in same direction as loose end of hair spring points. Using tweezers, carefully line up hair spring so that coils are equally spaced and do not touch one another when speed cup is in any position. Fasten speed unit to main frame (three screws). Refer to figure 83 for correct position. Test speed cup for trueness and free turning.

f. **Replace Odometer Intermediate Gear Assembly.** Place washer on odometer drive gear shaft and place in odometer frame. Place washer over inside end of shaft. Set assembly on anvil of staking fixture (T-178717 Det 4) and, using a female punch, drive spur gear as far as it will go on shaft. Using staking tool (T-178717 Det 3),

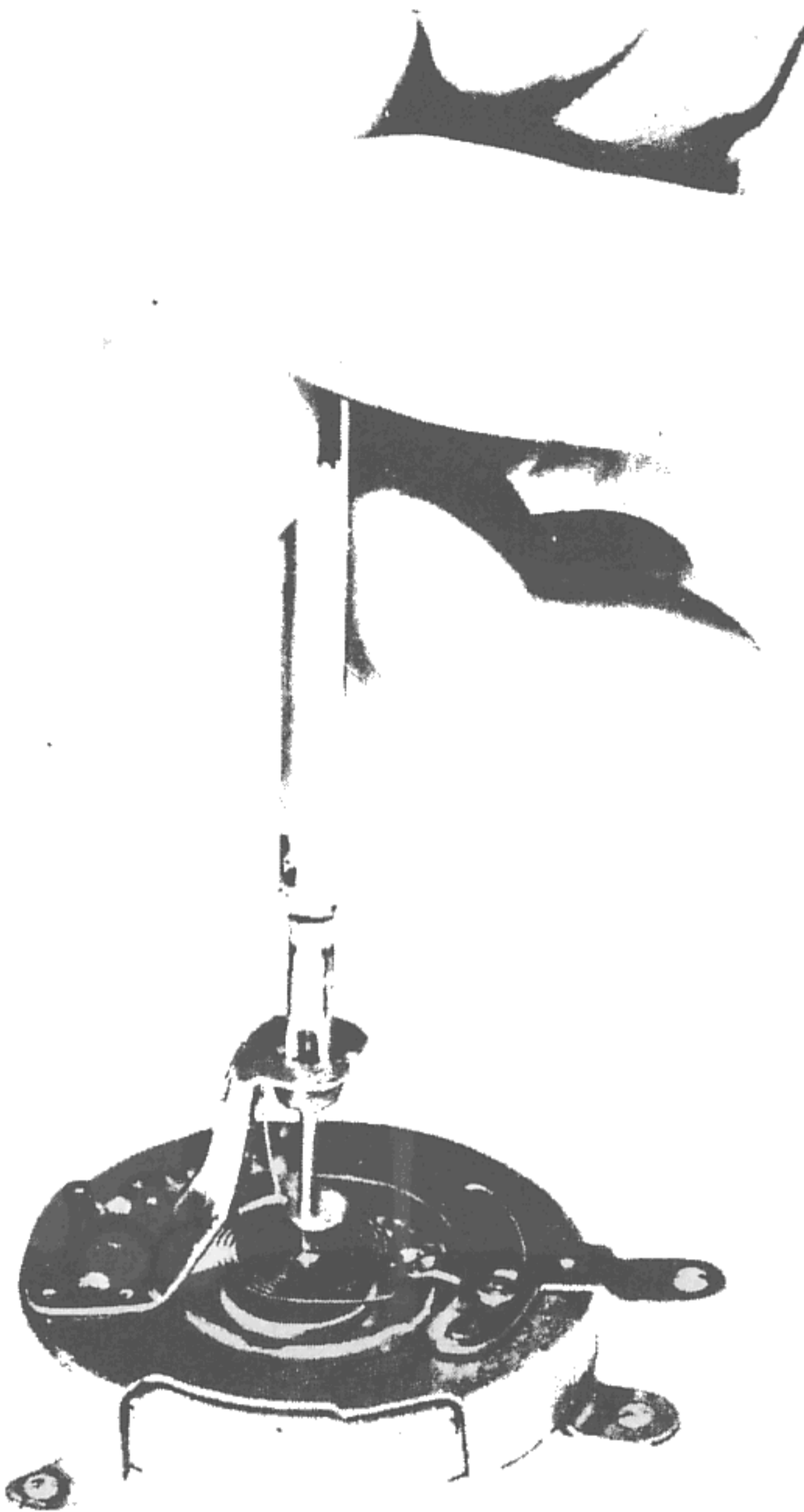
**SPEEDOMETERS AND TACHOMETERS WITH FLAT DISK-TYPE  
MAGNETS**

RA PD 318981

**Figure 96—Adjusting Front Jewel, Using Special Tool (T-178705)**

stake inside end of drive gear shaft securely (fig. 98). Check to see that gear turns freely.

g. **Replace Odometer Assemblies.** Place total odometer in frame and fasten with clip and screw (fig. 81) or with spring clip (fig. 99), depending upon type of odometer retainer used. Place trip odometer assembly (fig. 100) in frame (with tenth dial spring inside frame) and fasten with clip and screw (fig. 81). Lubricate gear teeth of third gear with small amount of No. 00 Grease, O.D., and place in position

## ORDNANCE MAINTENANCE SPEEDOMETERS, TACHOMETERS, AND RECORDERS

in main frame (fig. 101). Make sure that small friction washer is on upper end of third gear shaft, and fasten odometer assembly to frame with three screws (fig. 99). Test for binds in odometer gearing.

**h. Replace Case.** Place mechanism in case and fasten with two screws and lock washers. If instrument has elbow joint, place small amount of No. 00 Grease, O.D., on gear teeth, screw bevel gear and sleeve assembly into elbow (fig. 80), and fasten assembly to back of instrument (fig. 79). If too much play is found in the gears after assembly, remove the bevel gear and sleeve (fig. 80) and lightly dress

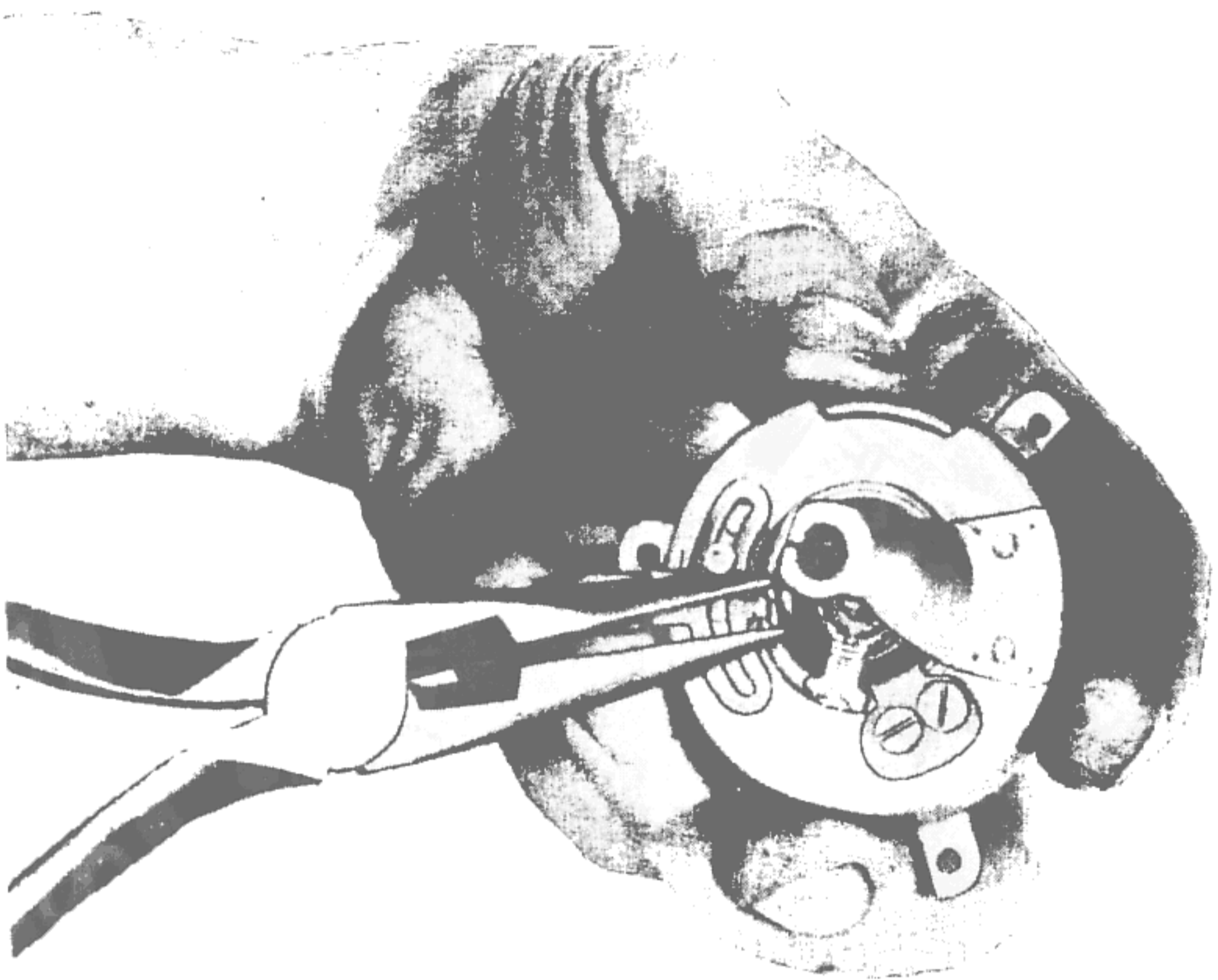

RA PD 318982

**Figure 97—Replacing Hair Spring Pin**

down the face of the brass sleeve (with a file) until a closer meshing of gear teeth is obtained.

**i. Calibrate.** Hold dial in position, and press pointer lightly on staff at zero. Place unit on calibrating machine, hold in same position as it will be on vehicle, run master head on machine at 10 miles per hour and make any necessary corrections in instrument by adjusting hair spring collet on staff (fig. 72). If instrument is excessively fast it may be necessary to install a stronger hair spring or shorten the hair spring. Cutting off one coil will slow up instrument about 6

## SPEEDOMETERS AND TACHOMETERS WITH FLAT DISK-TYPE MAGNETS

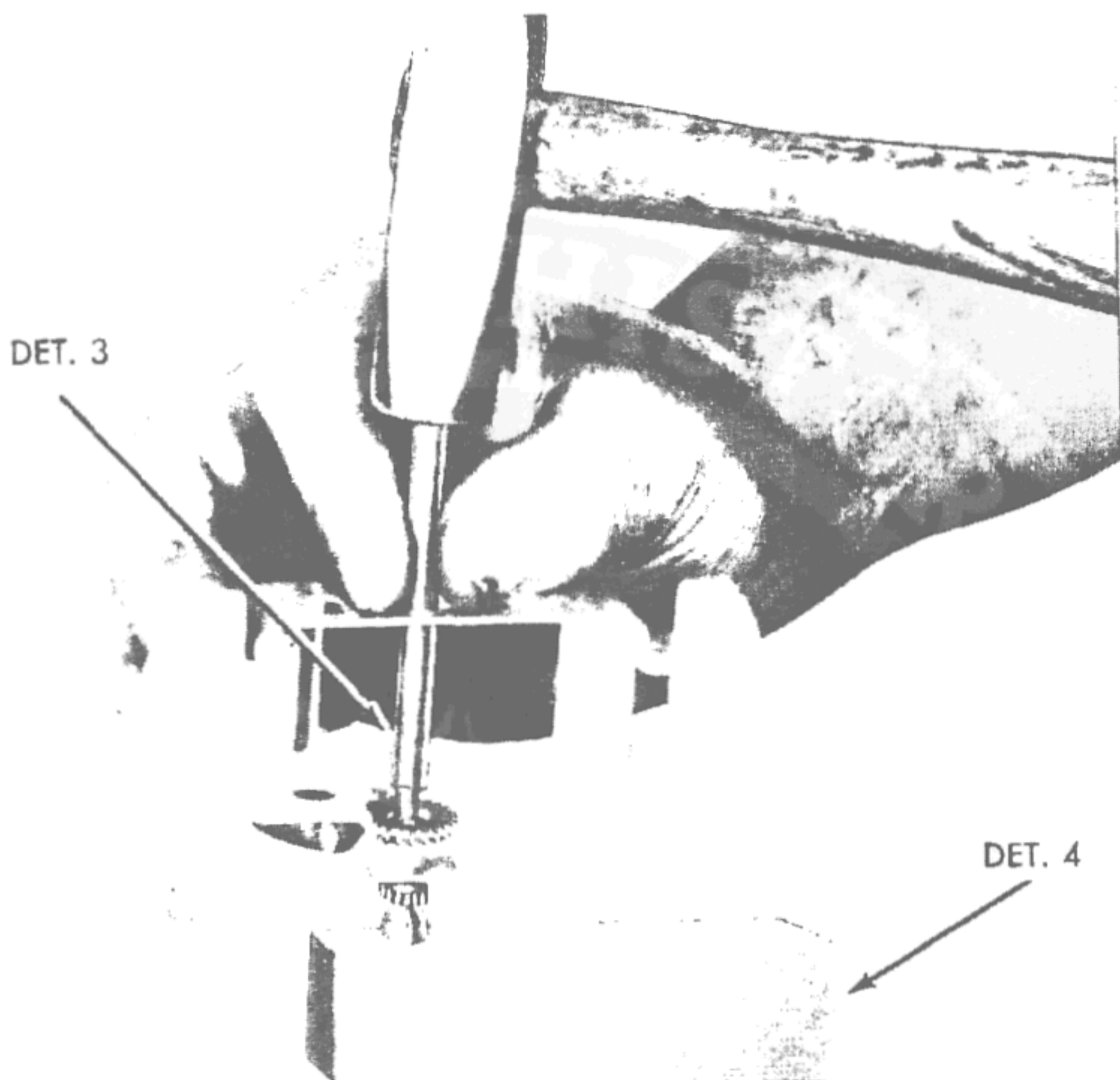

RA PD 318983

**Figure 98—Staking Intermediate Gear, Using Fixture (T-178717)**

miles per hour. Not more than three coils should be removed. Allow pointer to return to zero to check whether it returns easily. Run master at 30 and 60 miles per hour. If instrument is too slow at high speeds either a weaker hair spring must be installed (par. 35 e), or the magnet strengthened with the magnet regulator (fig. 102). If instrument is too fast at high speeds, either the magnet must be weakened with the magnet regulator (fig. 102) or the hair spring tension increased. Fasten face dial in position, start pointer on staff at about one-half dial reading, and press it on as it is turned to zero. Check instrument at all speeds and refine calibration to within limits below by moving hair spring regulator (fig. 83) or by moving the magnet regulator as follows: Remove hole plug at back of case, using adjusting kit (T-178715) to catch on magnet regulator. Place key in square hole in magnet shaft and turn magnet clockwise to increase, and counterclockwise to decrease speed of the instrument (fig. 102). Replace regulator hole plug. If instrument cannot be calibrated, refer to paragraph 4.

**ORDNANCE MAINTENANCE  
SPEEDOMETERS, TACHOMETERS, AND RECORDERS**

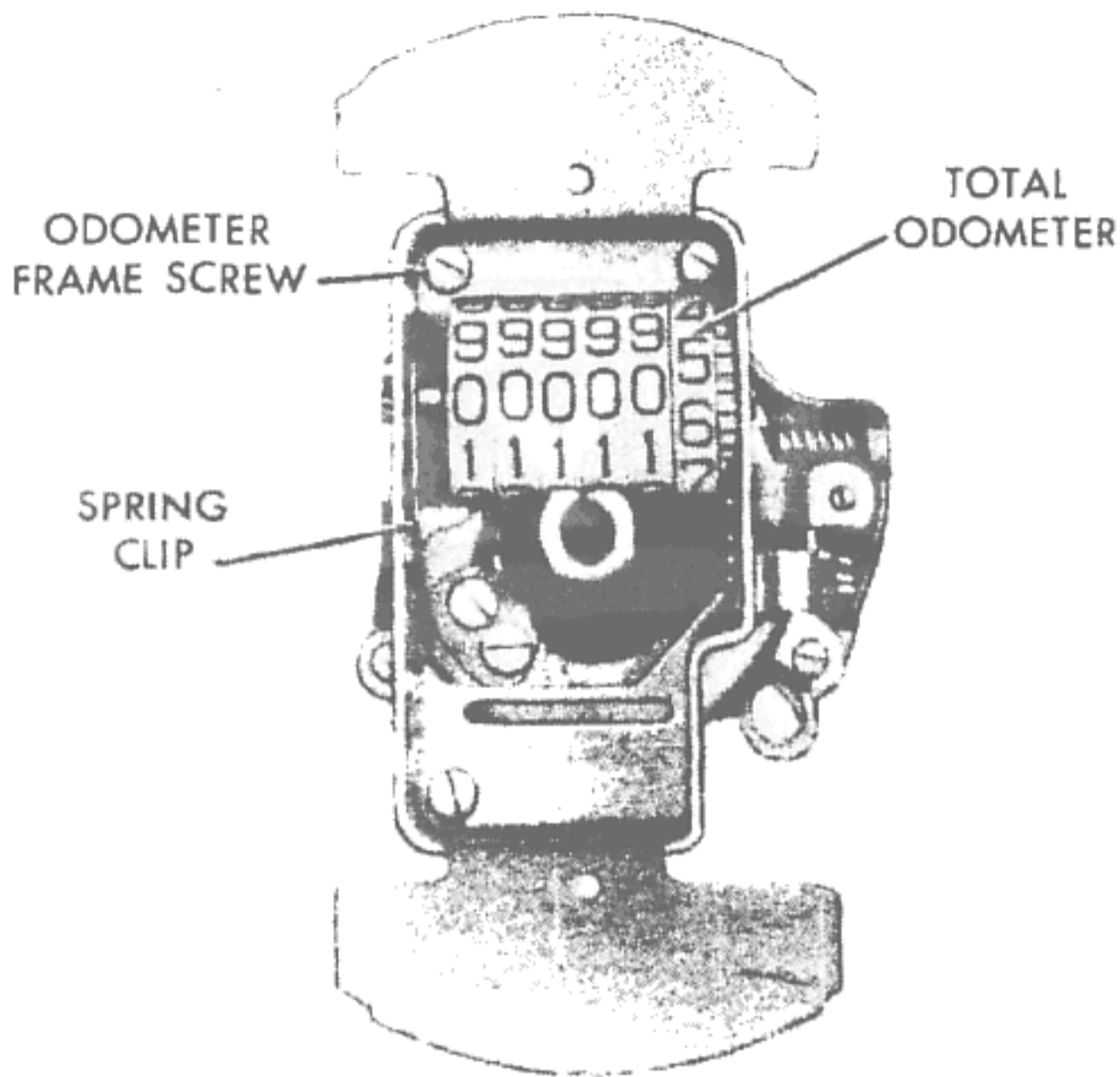

RA PD 318984

**Figure 99—Odometer Frame with Total Odometer in Place**

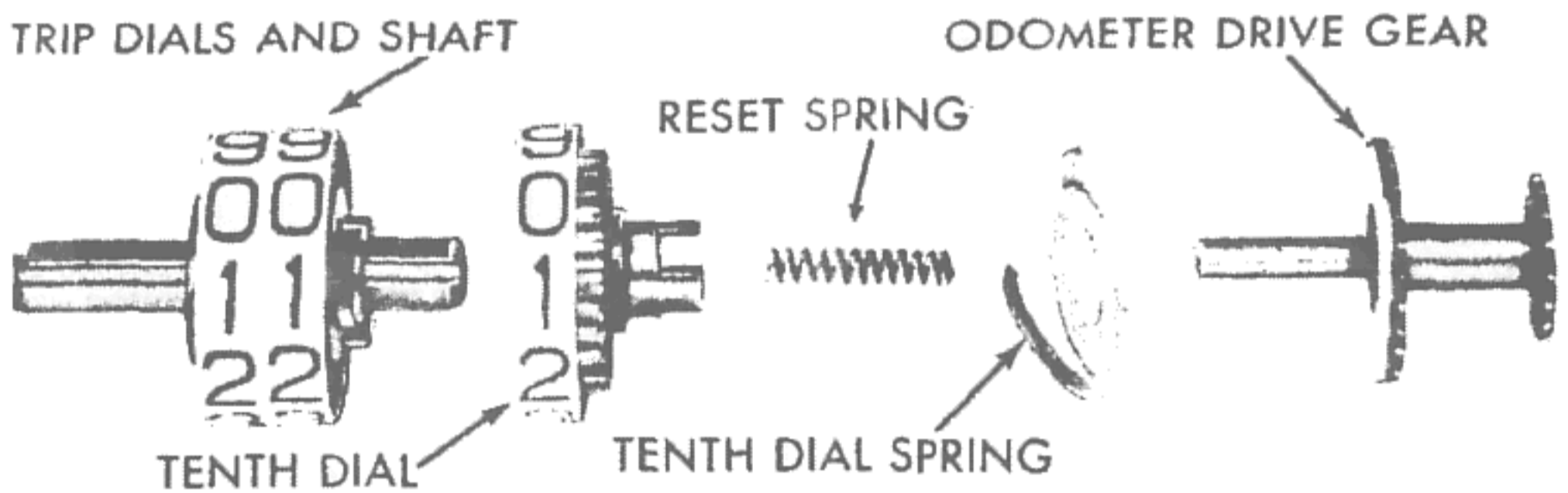

RA PD 318985

**Figure 100—Trip Odometer and Attaching Parts**

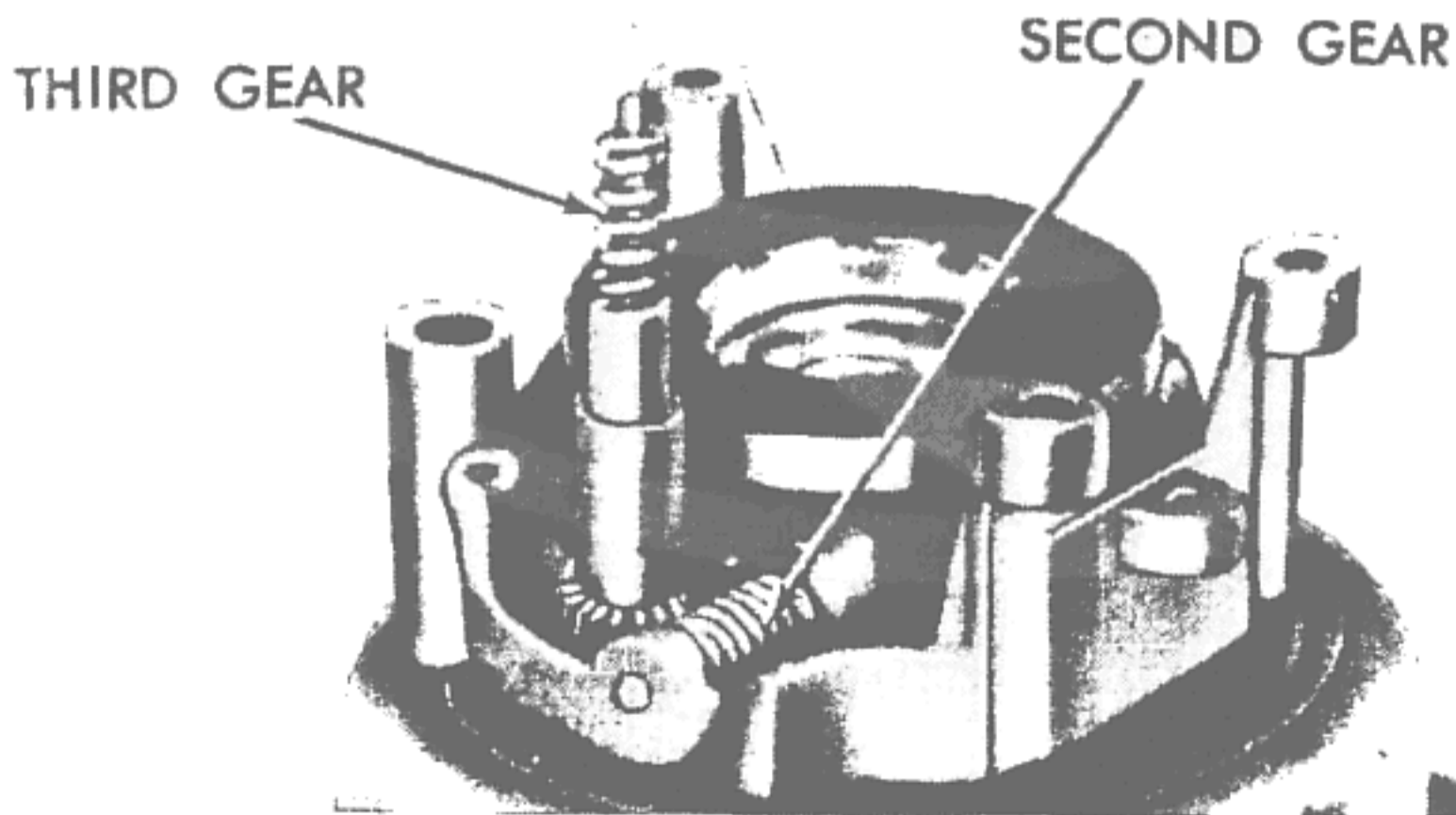

RA PD 318986

**Figure 101—Mechanism with Speed Unit and Odometer Frame  
Removed to Show Position of Second and Third Gears**

**SPEEDOMETERS AND TACHOMETERS WITH FLAT DISK-TYPE  
MAGNETS**

Master Reading	Calibration Tolerances
10 mph .....	9-11 mph
30 mph .....	30-32 mph
60 mph .....	60-63 mph

j. Replace Bezel, Gaskets, Glass, etc. Refer to paragraph 31 n.

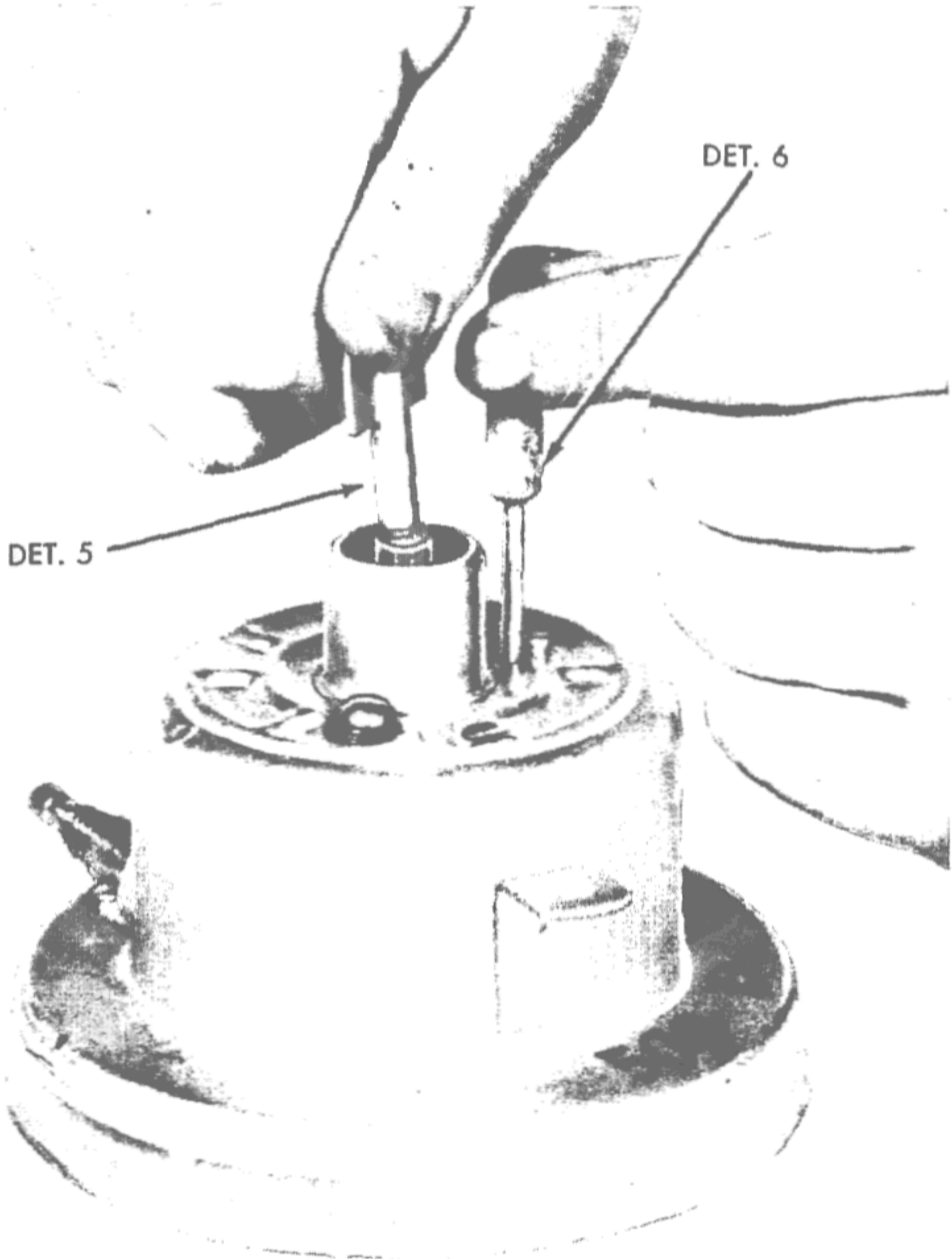

RA PD 318987

**Figure 102—Moving Magnet Regulator, Using Adjusting Kit  
(T-178715)**

**ORDNANCE MAINTENANCE  
SPEEDOMETERS, TACHOMETERS, AND RECORDERS**

Section III

**CENTRIFUGAL TACHOMETERS (Type 424)**

**36. DESCRIPTION AND OPERATION.**

a. **Description.** The Stewart-Warner 424 tachometer (figs. 103 and 104) is of the centrifugal type for the identification of revolutions per minute. This tachometer indicates crankshaft speed when driven at one-half crankshaft speed. The face dial is usually divided into readings of 50 revolutions per minute and the graduations are

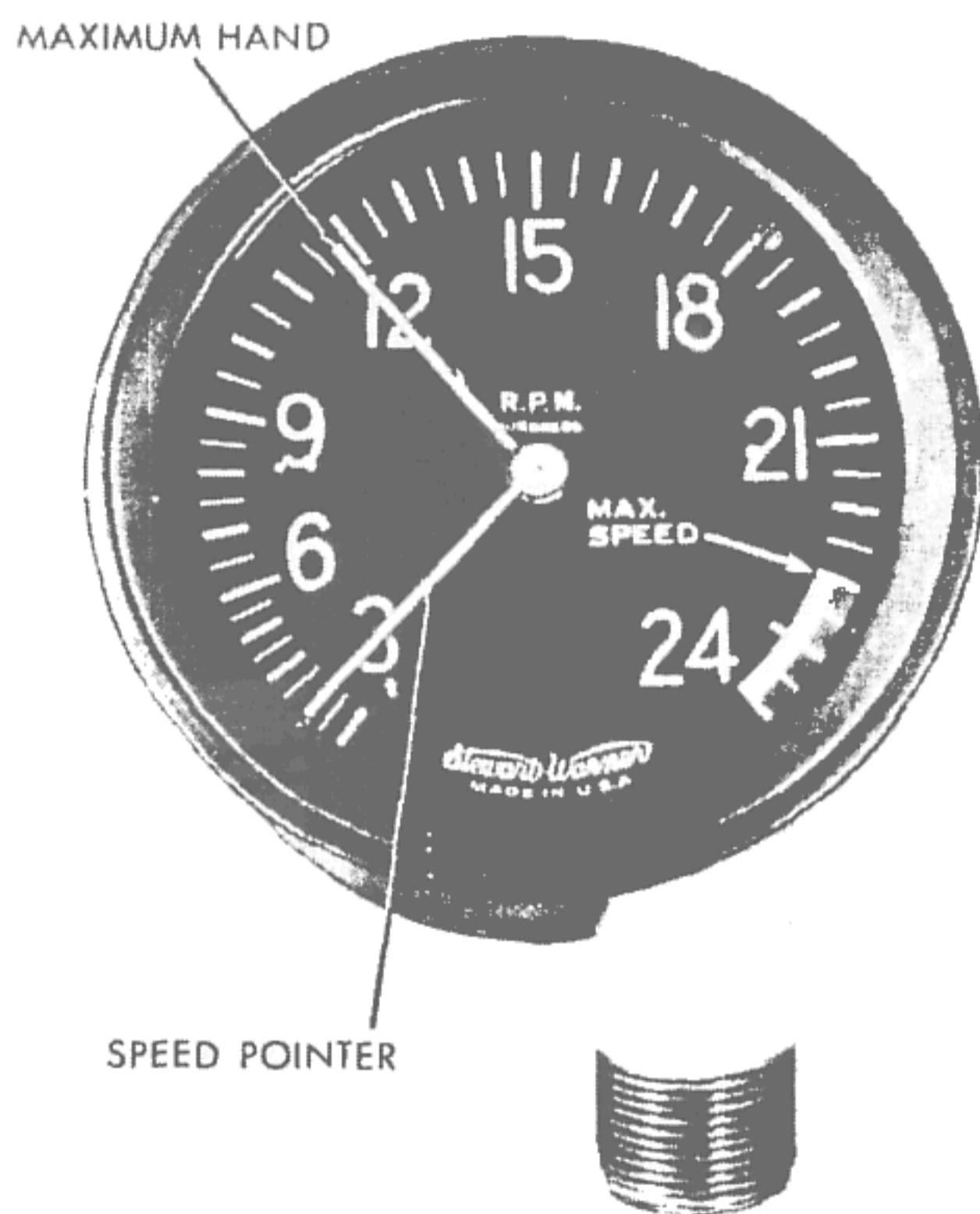

RA PD 318988

**Figure 103—Stewart-Warner Centrifugal Tachometer**

evenly spaced. Most models include a "maximum" hand, which automatically locks at the maximum speed (revolutions per minute) at which the engine is operated. The maximum hand-locking device is usually sealed, so that vehicle operator cannot release it and return it to zero, thus making sure that engines are operated within proper limits. Being of the centrifugal type, these instruments will indicate revolutions per minute regardless of direction of shaft rotation, and are not affected by temperature or vibration. The outside case is weatherized. The basic mechanism consists of a flyball-type governor assembly.

CENTRIFUGAL TACHOMETERS

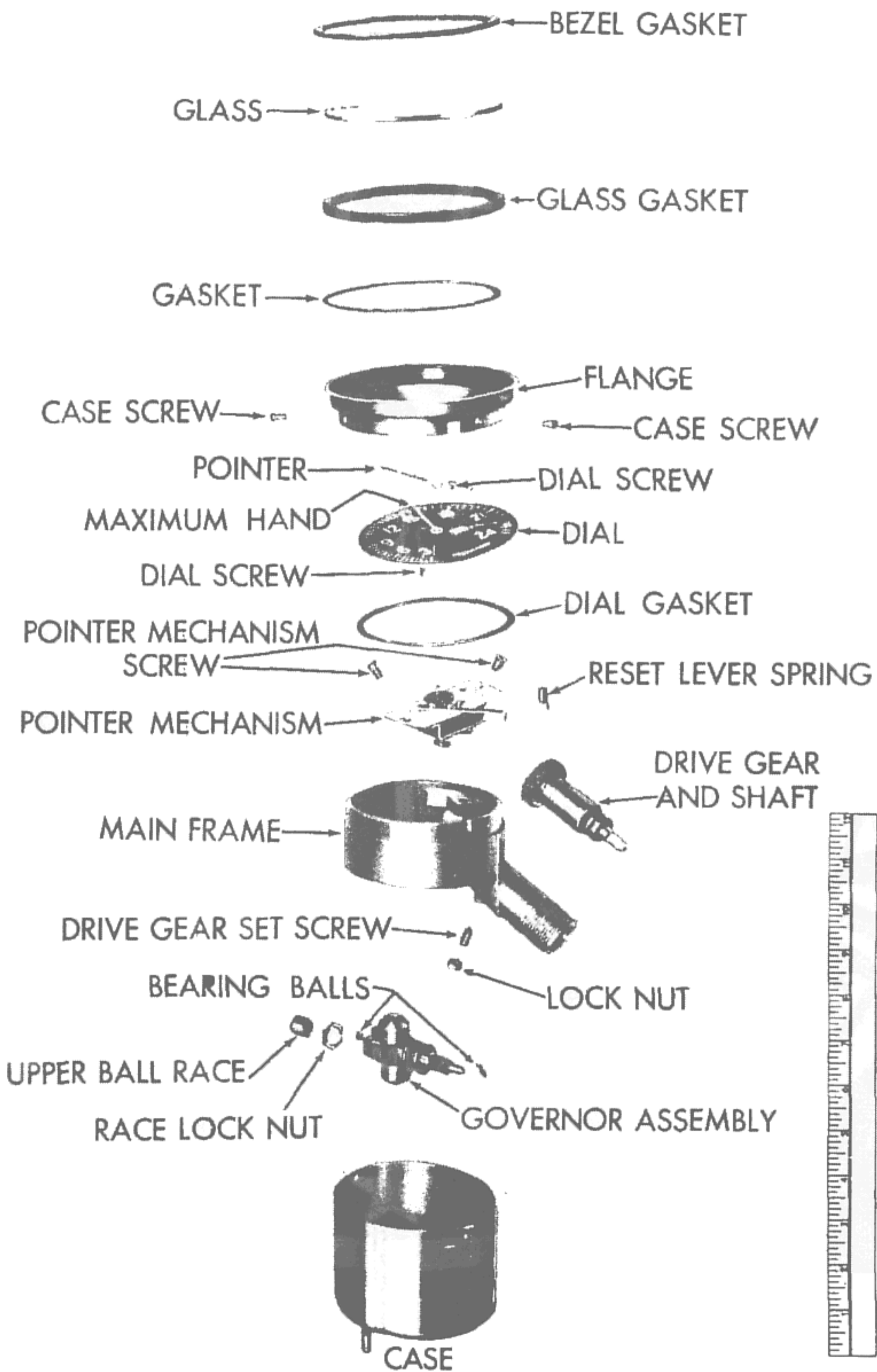

RA PD 318989

Figure 104—Stewart-Warner Centrifugal Tachometer, Disassembled



**ORDNANCE MAINTENANCE  
SPEEDOMETERS, TACHOMETERS, AND RECORDERS**

b. **Operation** (fig. 105). The flexible shaft turns the drive shaft housed in drive sleeve (B). On the end of drive shaft is a helical drive gear (J), made of fiber. This drive gear meshes with the pinion on the governor shaft (K). On the governor shaft are two weights (D) diametrically opposite each other. Each weight is connected with each link by a pin which allows the parts to hinge. One end of the link is pivoted freely to a fixed spider (M) on the governor shaft; the other link end is pivoted freely to a sleeve (C) which slides readily over the governor shaft. Trapped in between the fixed spider and sleeve on governor shaft is a spring which balances the centrifugal force at a given speed, and acts as a restoring force when speed is reduced. Placed on the upper spider is an overspeed stop pin (E)

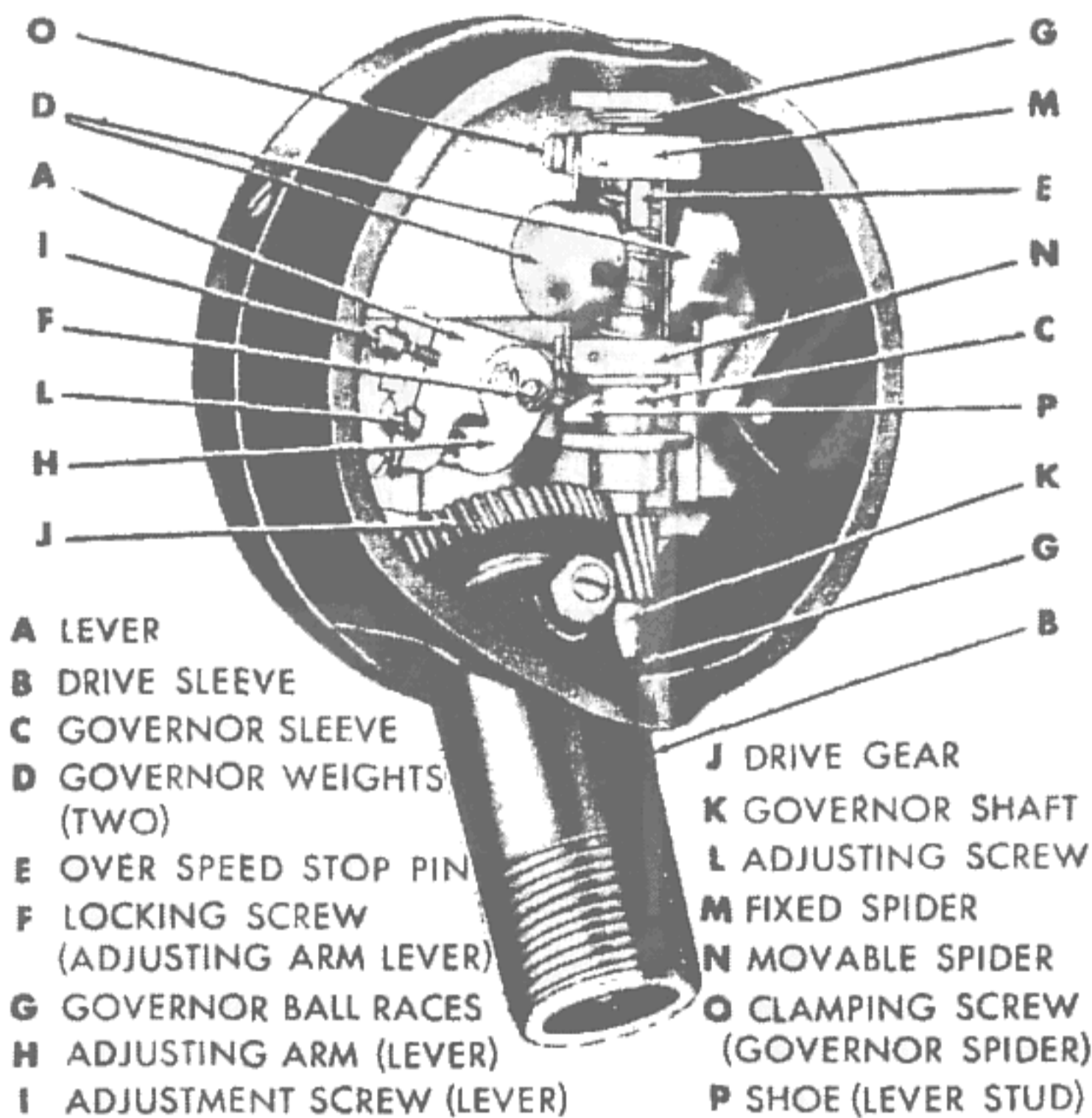

RA PD 318990

**Figure 105—Centrifugal Tachometer Mechanism Installed**

which prevents the governor spring from setting coil upon coil. As the governor shaft (K) revolves, the two weights (D) are thrown outward, due to centrifugal force, raising the sliding sleeve (C), the shoulder of which engages a flat shoe (P), pivotally mounted on lever (A) which, through a suitable gear train, pivoted on the same center as the lever, engages a pinion (not shown) on the pointer shaft, moving the pointer and indicating the revolutions per minute. The pointer shaft has a bronze hair spring for returning the pointer to zero and providing a means of removing any lost motion in this train of parts.

## CENTRIFUGAL TACHOMETERS

## 37. BENCH TEST PROCEDURE.

a. **Test for Tight Mechanism.** This is done by using a short piece of inner core (3 to 4 inches long) with proper tip to fit the drive position at neck of instrument being tested (fig. 14). If tightness or binding is apparent it is caused by lack of lubrication in governor shaft or drive shaft bearings, dirty mechanism, or stripped drive gear. Instrument must be disassembled and repaired before further tests can be made.

b. **Test Calibration.** Providing instrument is not "bound up" (test a, above) place it on the calibrating machine (T-170645) and run at various speeds. Note instrument readings obtained as compared with master head. The causes and remedies of any irregularities can be found by referring to subparagraph c following.

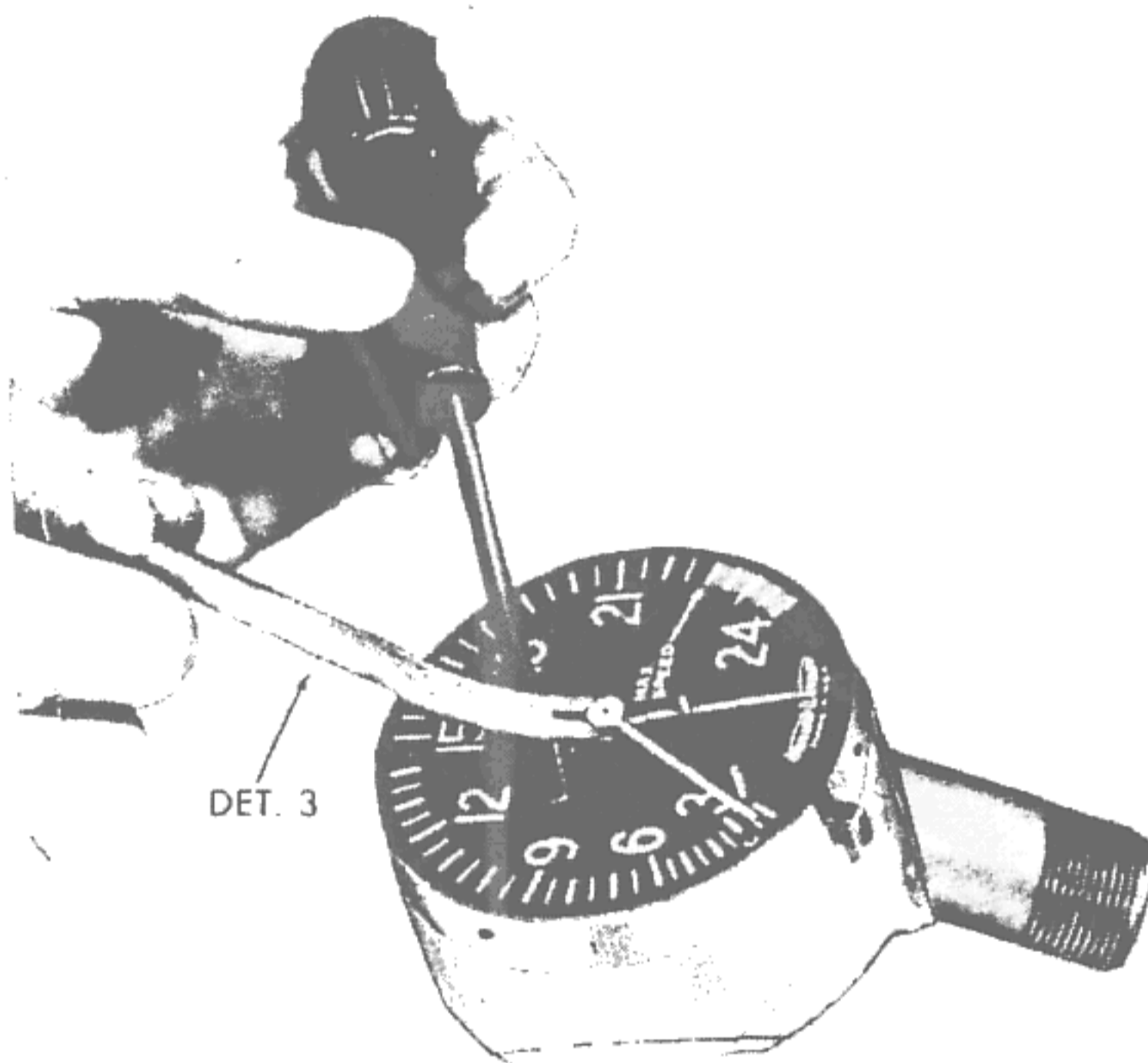

RA PD 318991

**Figure 106—Removing Pointer, Using Lifter (T-29 Det 3)**

c. **Probable Causes and Remedies of Defective Tachometers.**

(1) **POINTER FLUCTUATES OR WAVERS.**

(a) *Stripped Drive Gear.* Replace with new part.

(b) *Dirty or Worn Governor Assembly or Pointer Mechanism.* Clean or replace.

(2) **STICKY POINTER (POINTER DOES NOT RETURN TO ZERO).**

(a) *Weak or Broken Hair Spring.* Replace pointer mechanism (includes hair spring).

(b) *Worn or Dirty Gears in Pointer Mechanism.* Clean or replace.

(c) *Defective Maximum Hand.* Indicating pointer may catch on maximum hand, which can be corrected by bending.

**ORDNANCE MAINTENANCE  
SPEEDOMETERS, TACHOMETERS, AND RECORDERS**

(3) **POINTER REMAINS AT ZERO.**

(a) *Stripped Drive Gear.* Replace.

(b) *Defective or Dirty Governor Assembly or Pointer Mechanism.* Clean or replace.

(c) *Defective Maximum Hand.* Ratchet at back of face dial may be so tight that indicating pointer cannot push maximum hand forward. Correct by bending ratchet spring.

(4) **EXCESSIVE NOISE.** Due to principles of operation, centrifugal-type tachometers are necessarily noisier in operation than magnetic-type instruments. Therefore, a whirring noise in the instrument when operated at high speed does not necessarily indicate trouble.

**POINTER MECHANISM**

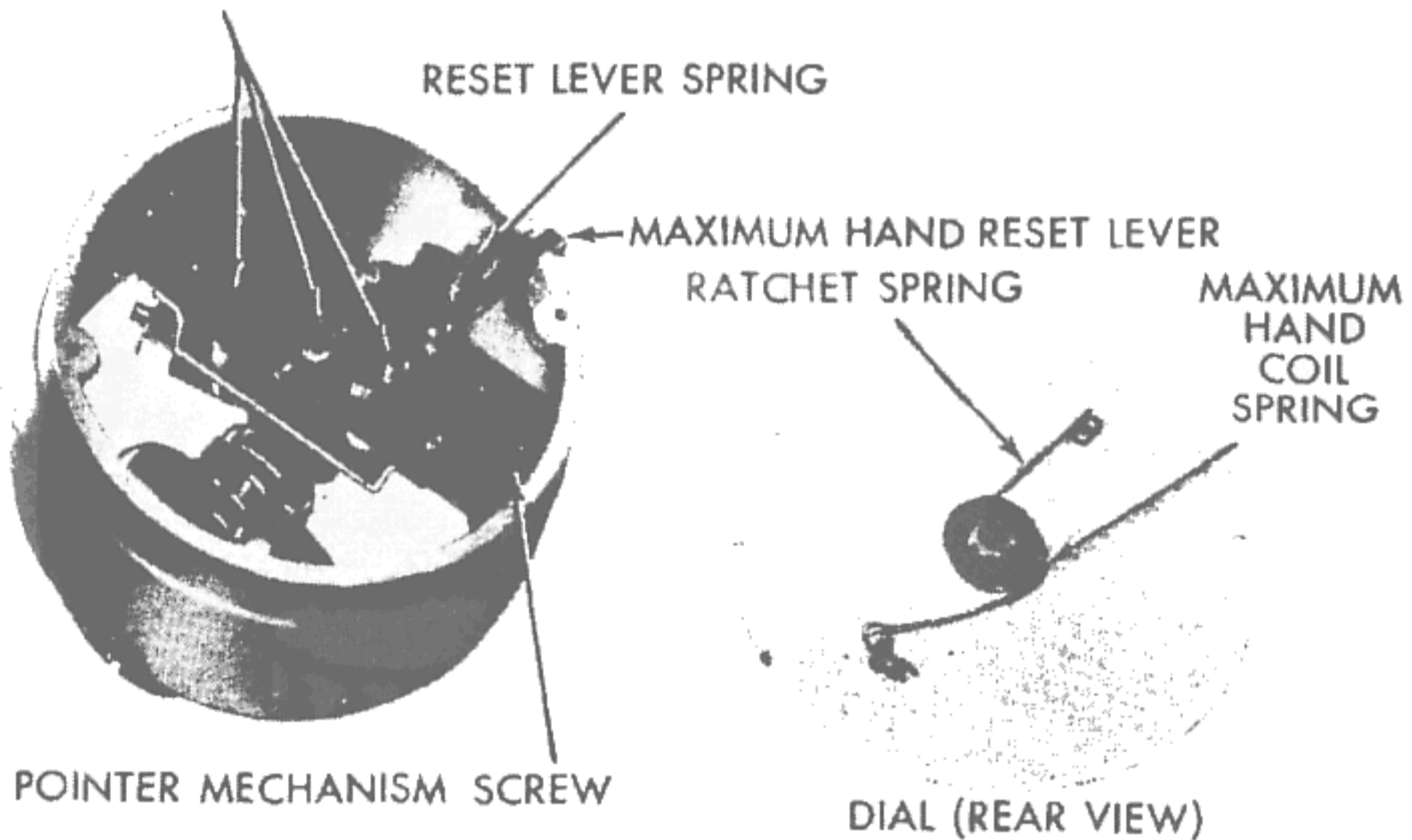

RA PD 318992

**Figure 107—Tachometer Mechanism (Dial Removed) and Rear View of Dial**

**38. DISASSEMBLY.**

a. **Remove Bezel and Case.** Remove four screws holding bezel and case to frame, and remove bezel and case.

b. **Remove Indicating Pointer and Face Dial.** Using lifter (T-29 Det 3) pry indicating pointer loose (fig. 106). Remove two screws and lift off face dial and maximum hand assembly.

c. **Remove Pointer Mechanism.** Remove maximum hand reset lever spring (fig. 107). Remove two screws (fig. 107) and lift out pointer mechanism.

d. **Remove Governor Assembly.** Loosen upper spider set screw (O, fig. 105). Using thin 1/2 inch open-end wrench, loosen upper ball race lock nut while holding race with screwdriver (fig. 108). While holding governor mechanism against upper ball race (to prevent tiny

## CENTRIFUGAL TACHOMETERS

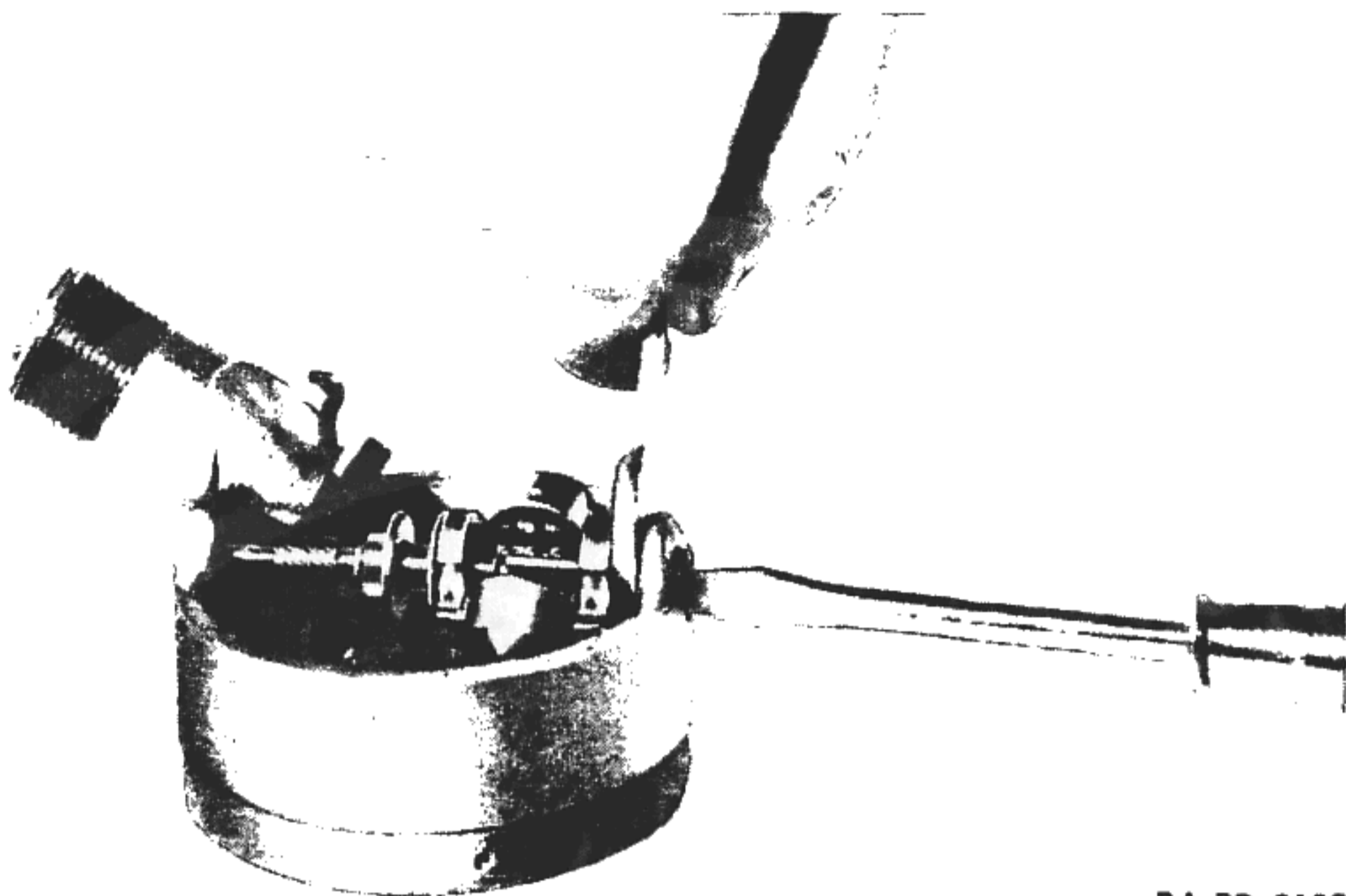

RA PD 318993

**Figure 108—Loosening Upper Ball Race Lock Nut**

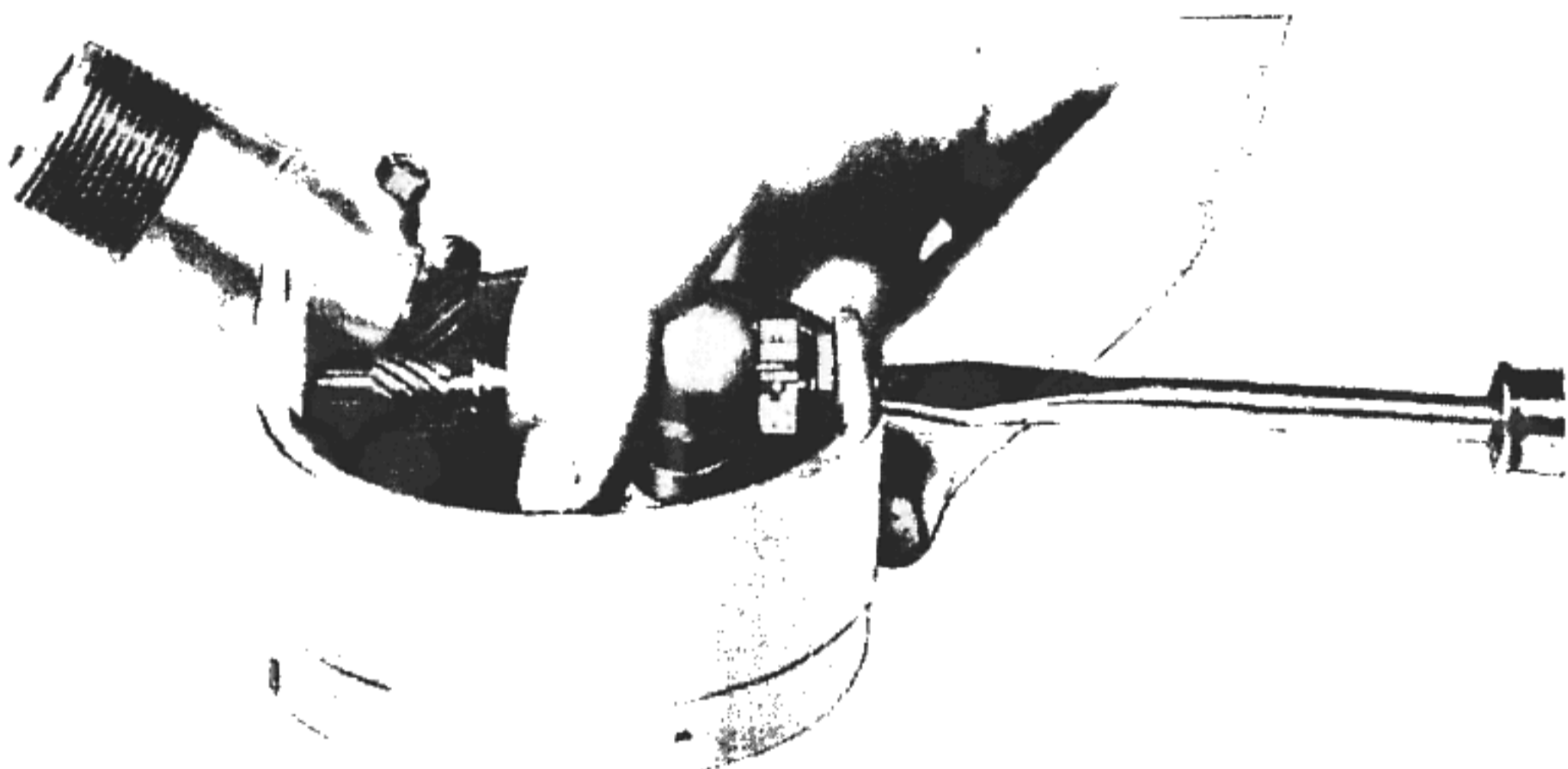

RA PD 318994

**Figure 109—Unscrewing Upper Ball Race**

bearing balls from falling out), unscrew upper ball race (fig. 109). Then lift out governor mechanism and 18 bearing balls (9 at each end of governor shaft).

e. **Remove Drive Gear and Shaft.** Loosen lock nut and set screw and pull out drive gear and shaft assembly (J, fig. 105).

### 39. CLEANING, INSPECTION, AND REPAIR OF PARTS.

a. **General Cleaning.** Thoroughly clean all metal parts with brush (T-170755) and a dry-cleaning solvent. Make sure to remove

## ORDNANCE MAINTENANCE SPEEDOMETERS, TACHOMETERS, AND RECORDERS

every trace of grease, dirt, and lint so that any defects will be easily found. Carefully dry parts with compressed air. **CAUTION:** *Handle pointer mechanism very carefully to prevent injury to precision parts.*

b. **Face Dial and Maximum Hand Assembly.** Move maximum hand clockwise away from pointer stop pin. Ratchet spring (fig. 107) should make barely audible sound when this is done, and should hold maximum hand in position until manually released, allowing coil



RA PD 318995

**Figure 110—Removing Governor Shaft**

spring to return maximum hand counterclockwise to pointer stop. If tension is too great or too small, it can be easily adjusted by carefully bending ratchet spring.

c. **Pointer Mechanism Assembly.** Do not move or tamper with parts of pointer mechanism, as this precision unit is factory-adjusted with special equipment, and is therefore furnished only as an assembly for service. Tampering with or removing any parts of this assembly will necessitate its replacement. Inspect gears and shoe for excessive wear. If any parts are defective or damaged, discard entire assembly.

## CENTRIFUGAL TACHOMETERS

d. **Governor Assembly.** Inspect ends of shaft and disk assembly for excessive wear and corrosion. Be sure spring and flyball links are not broken. If defective discard entire assembly. Carefully inspect tiny steel bearing balls for wear.

e. **Drive Gear Assembly.** Check for free turning and for excessive side and end play of shaft in bearing. Check fiber gear for broken teeth and excessive wear. If defective, discard entire assembly.

### 40. ASSEMBLY AND CALIBRATION.

a. **Replace Drive Gear Assembly.** If ball-bearing type, lubricate balls with white petroleum jelly. If sleeve-type bearing, lubricate drive gear shaft with several drops of clock oil. Place assembly in frame and tighten set screw securely, then tighten lock nut.



RA PD 318996

**Figure 111—Adjusting Clearance Between Upper Spider and Upper Ball Race**

b. **Replace Governor Assembly.** Cover bearing balls with petroleum jelly and place in ball races (nine balls in each race). Place special screwdriver (T-51742) in slot in upper spider (fig. 110), spread spider, and pull out governor shaft. Lubricate shaft with white petroleum jelly and replace. Then pull screwdriver out of slot in upper spider. Start upper ball race lock nut onto upper ball race about two or three threads. Place upper end of governor shaft in upper ball race, then lower end of shaft in lower ball race. Tighten down upper ball race (fig. 109), allowing about 0.002-inch end play in governor shaft. While holding upper ball race with screwdriver, tighten lock nut securely (fig. 108). Place special screwdriver (T-51742) in slot in upper spider, and move flyball assembly on governor shaft (fig. 111) until there is about  $\frac{1}{16}$ -inch clearance between upper spider and upper ball race. Then remove screwdriver from slot and tighten set screw (O, fig. 105). Test for free turning.

## ORDNANCE MAINTENANCE SPEEDOMETERS, TACHOMETERS, AND RECORDERS

c. **Replace Pointer Mechanism.** Lubricate gears with small amount of watch and clock oil. Place pointer mechanism in frame, making sure that shoe is properly positioned (P, fig. 105). Fasten securely with two screws (fig. 107). Replace maximum hand reset lever spring.

d. **Replace Face Dial.** When placing face dial on frame make sure that maximum hand reset lever is in proper position so that maximum hand returns to pointer stop pin when this lever is depressed. Also be sure ratchet adjustment is correct (par. 39 b). Fasten face dial in place (two screws).

e. **Calibrate.** All Stewart-Warner centrifugal tachometers are calibrated two to one (indicate twice the revolutions per minute of

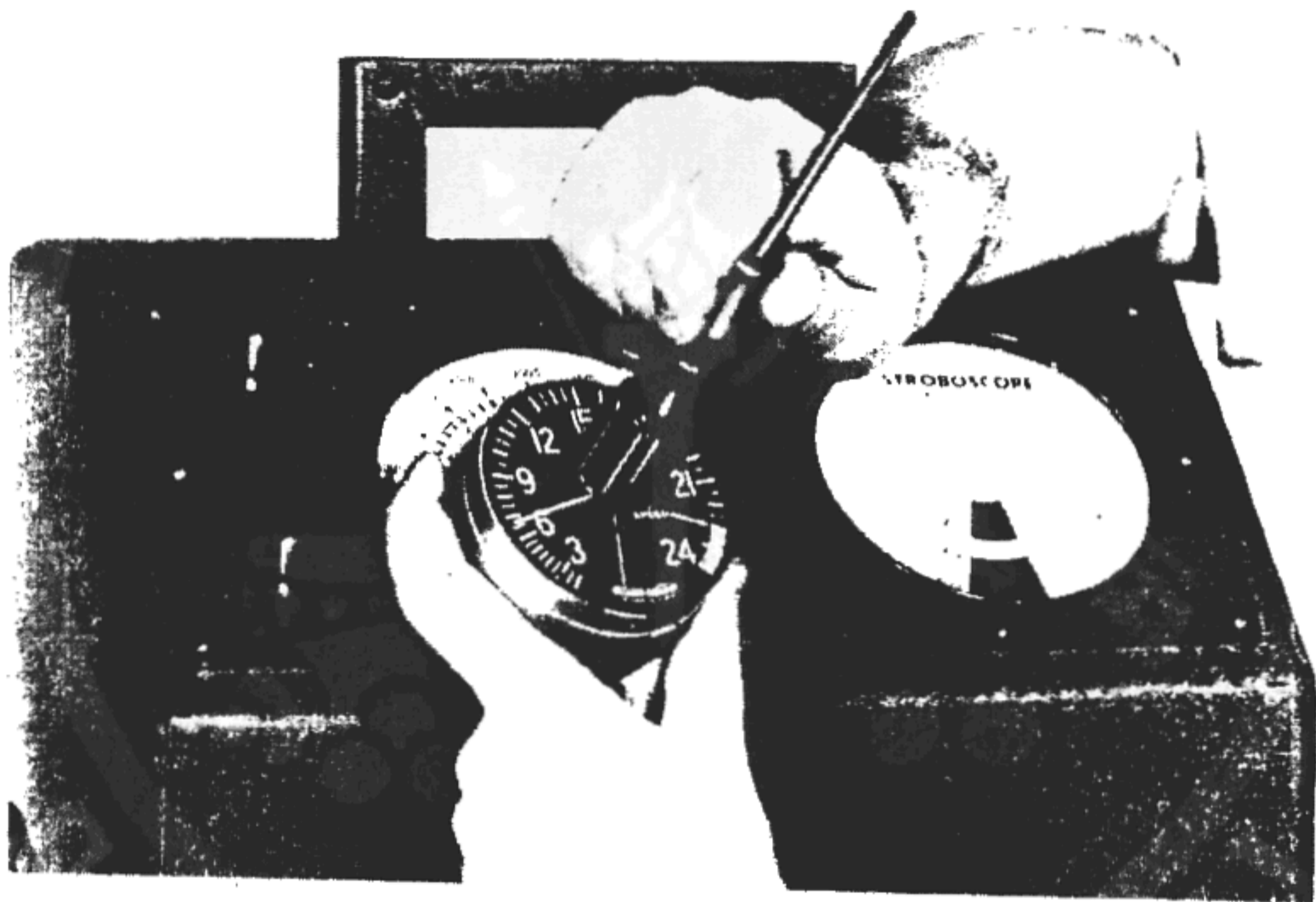

RA PD 318997

**Figure 112—Tapping Pointer on Staff while Running on  
Calibrating Machine (T-170645)**

flexible shaft). Therefore, use spindle No. 1 of calibrating machine (T-170645), as master indicates twice the revolutions per minute at which this spindle turns (chapter 13). Place maximum hand out of way by turning clockwise to maximum dial reading. Place unit on calibrating machine, run master at 600 revolutions per minute, set pointer on staff at 650 revolutions per minute reading on unit being calibrated and tap pointer lightly onto staff with handle of screwdriver (fig. 112). If unit being calibrated does not have maximum hand, pointer should be set at actual master head reading and all points at which instrument is checked should agree with master head. The 50 revolutions per minute difference is necessary to offset

**CENTRIFUGAL TACHOMETERS**

the drag of the maximum hand. Run master at 1,800 revolutions per minute. Indicating pointer of unit being calibrated should read 1,850 revolutions per minute. If instrument is too fast or too slow at 1,800 revolutions per minute master reading, slow down calibrating machine until master head reads zero. Turn adjusting screw (I, fig. 105) clockwise if unit being calibrated is fast (turn counterclockwise if slow) one or two turns. Run master at 600 revolutions per minute, loosen indicating pointer and reset again at 650 revolutions per minute (fig. 112). Again run master at 1,800 revolutions per minute and if unit is still off, repeat above procedure (refining all adjustments) until unit is correctly calibrated. Then tap pointer securely onto staff.

f. **Replace Bezel and Case.** Place mechanism in case, replace glass, gaskets and bezel, and fasten with screws. Weatherize case with sealing or plugging cement.



### ORDNANCE MAINTENANCE SPEEDOMETERS, TACHOMETERS, AND RECORDERS

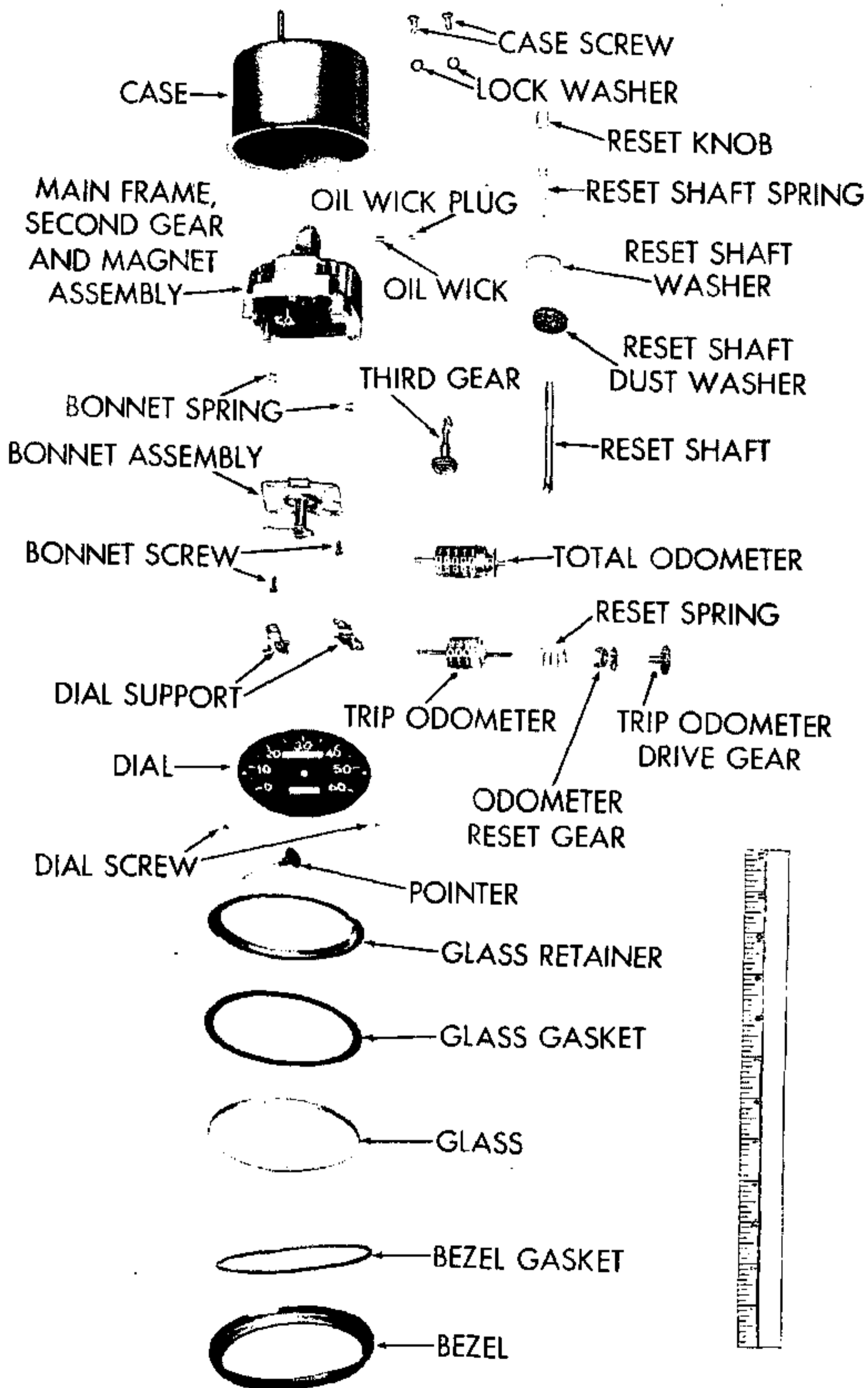

RA PD 318998

**Figure 113—Waltham Speedometer, Disassembled**

## CHAPTER 7

### WALTHAM SPEEDOMETERS

#### 41. DESCRIPTION.

a. The Waltham speedometer (fig. 113) can be definitely recognized (internally) by its molded disk magnet. For complete description, operation and test procedure refer to paragraphs 2 and 4.

#### 42. DISASSEMBLY.

a. **Remove Bezel and Case.** Pry bezel loose (with screwdriver) at two points about one inch apart. Use cutting pliers and tear out

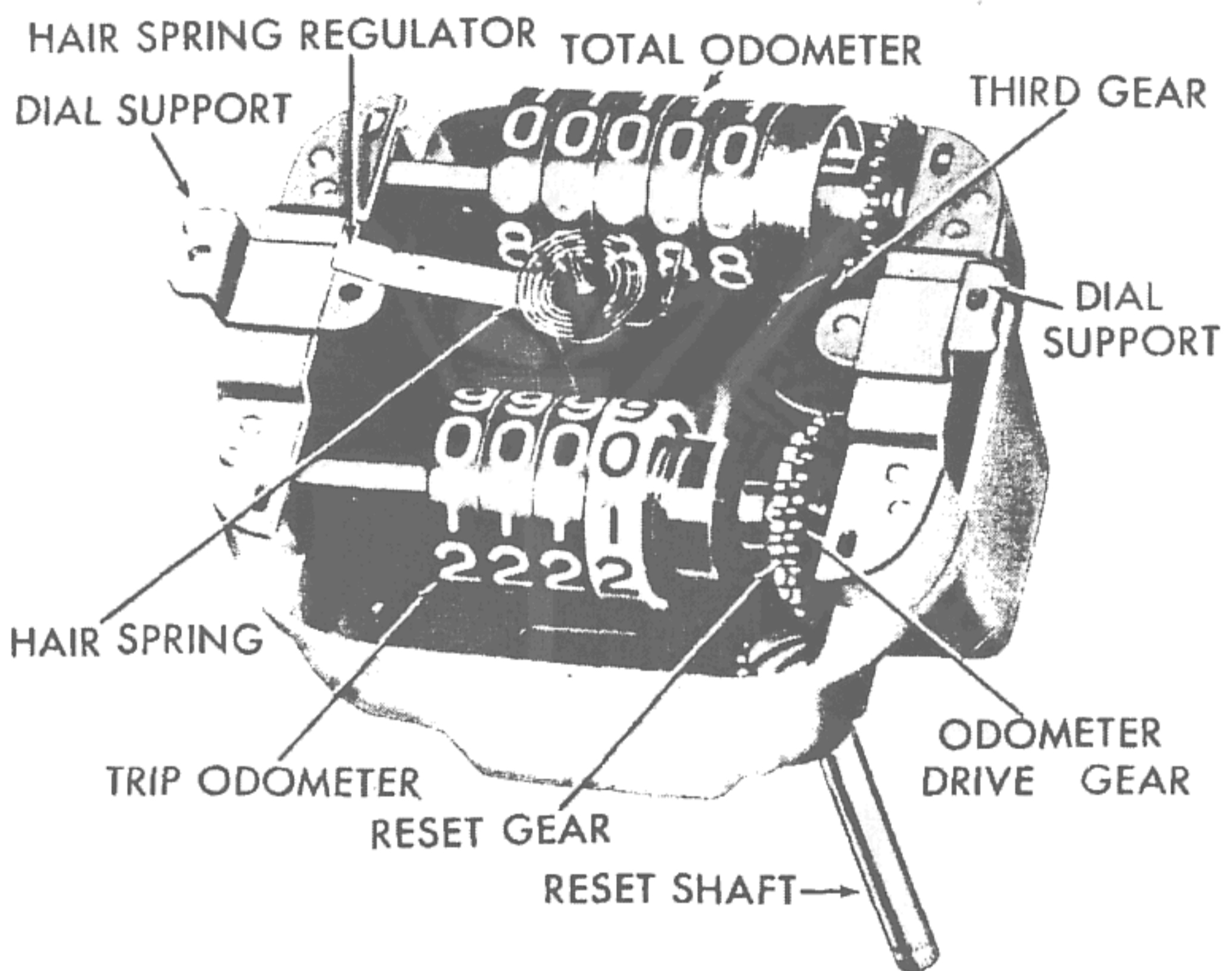

RA PD 313999

**Figure 114—Speedometer Mechanism (Dial Removed)**

this section of bezel (fig. 51). Then pull bezel off (fig. 52) and remove gaskets, glass, and retainer. Remove reset knob (press fit), and lift off reset spring and washers. Remove two case screws at back and lift out mechanism.

b. **Remove Pointer and Dial.** Remove pointer by grasping pointer hub between thumb and forefinger and twisting gently in counterclockwise direction (against stop), at the same time pulling pointer outward carefully. Then remove two dial retaining screws, and lift off dial.

c. **Remove Dial Supports, Odometers, Third Gear, and Reset Shaft** (fig. 114). Remove dial supports (two) by prying up with

## ORDNANCE MAINTENANCE SPEEDOMETERS, TACHOMETERS, AND RECORDERS

screwdriver. The odometers, third gear, and reset shaft may now be lifted out of frame. Be careful not to damage hair spring.

d. **Remove Bonnet Assembly.** Remove two screws and lift out bonnet assembly (includes hair spring, disk, and staff) (fig. 115) and two bonnet springs. Removal of second gear and magnet from frame, or further dismantling of bonnet assembly is not recommended.

e. **Remove Oil Wick.** Using punch remove oil wick plug from frame (fig. 63). Then lift oil wick out of frame (using tweezers).

### 43. CLEANING, INSPECTION, AND REPAIR OF PARTS.

a. **General Cleaning.** Thoroughly clean third gear, reset gear, tenth dial gear, reset shaft, brackets, springs, screws, and metal

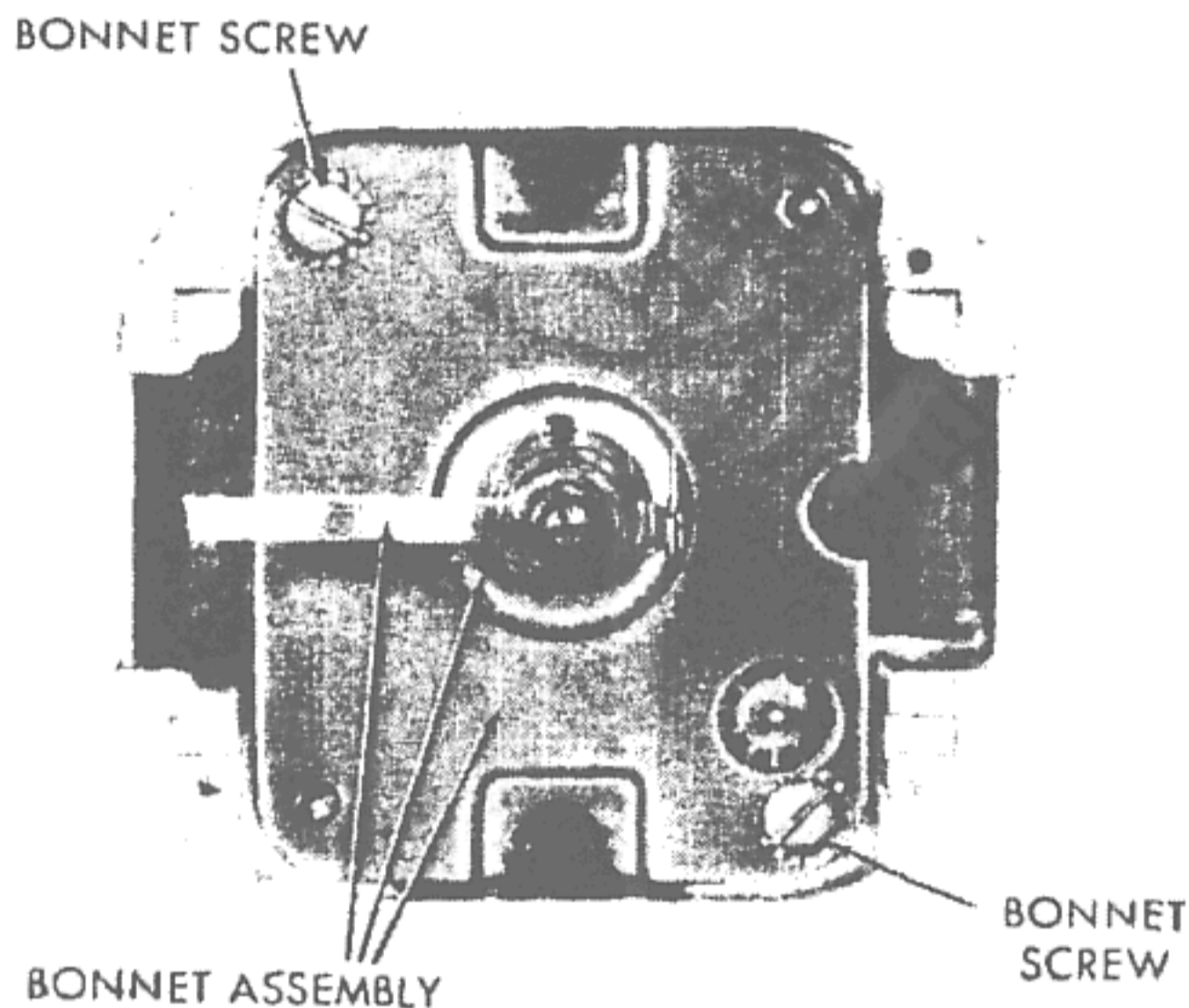

RA PD 319000

**Figure 115—Speedometer Mechanism (Odometers Removed)**

washers with brush (T-170755) and dry-cleaning solvent. Carefully dry parts. Wipe other parts clean with a rag. **CAUTION:** *When cleaning second gear be careful not to touch magnet with steel tools.*

b. **Bonnet Assembly.** Bonnet assembly should not be submerged in dry-cleaning solvent, but should be carefully and thoroughly wiped with a clean cloth. Inspect bonnet assembly to see that hair spring and lower pivot are not damaged. If necessary, adjust hair spring as follows: Turn aluminum disk clockwise until it stops against bonnet lug. Hold in this position and adjust hair spring (using tweezers) until coils are equidistant from each other and parallel to the bonnet. At no point of swing should the coils touch each other. To adjust tension, move regulator (fig. 114) approximately  $\frac{1}{4}$  inch to left, and set tension so that disk returns lightly to zero. This is done by turn-

## WALTHAM SPEEDOMETERS

ing hair spring collet on staff to the right or to the left, as required (fig. 72). Return spring regulator to center position.

c. **Main Frame, Second Gear, and Magnet Assembly.** Check magnet shaft for side play and excessive end play (about 0.003 inch is correct end play). Too much end play can be corrected by using fixture (T-170666 with Det 6) to reflare end of magnet shaft (fig. 92). **CAUTION:** *Care must be taken when using fixture to make sure that it does not come in contact with steel portion of magnet, causing it to be weakened.* Check gear teeth for wear. If any part is defective, entire assembly should be replaced.

d. **Third Gear and Trip Odometer Gears.** Check for excessive wear or broken teeth. Discard if defective.

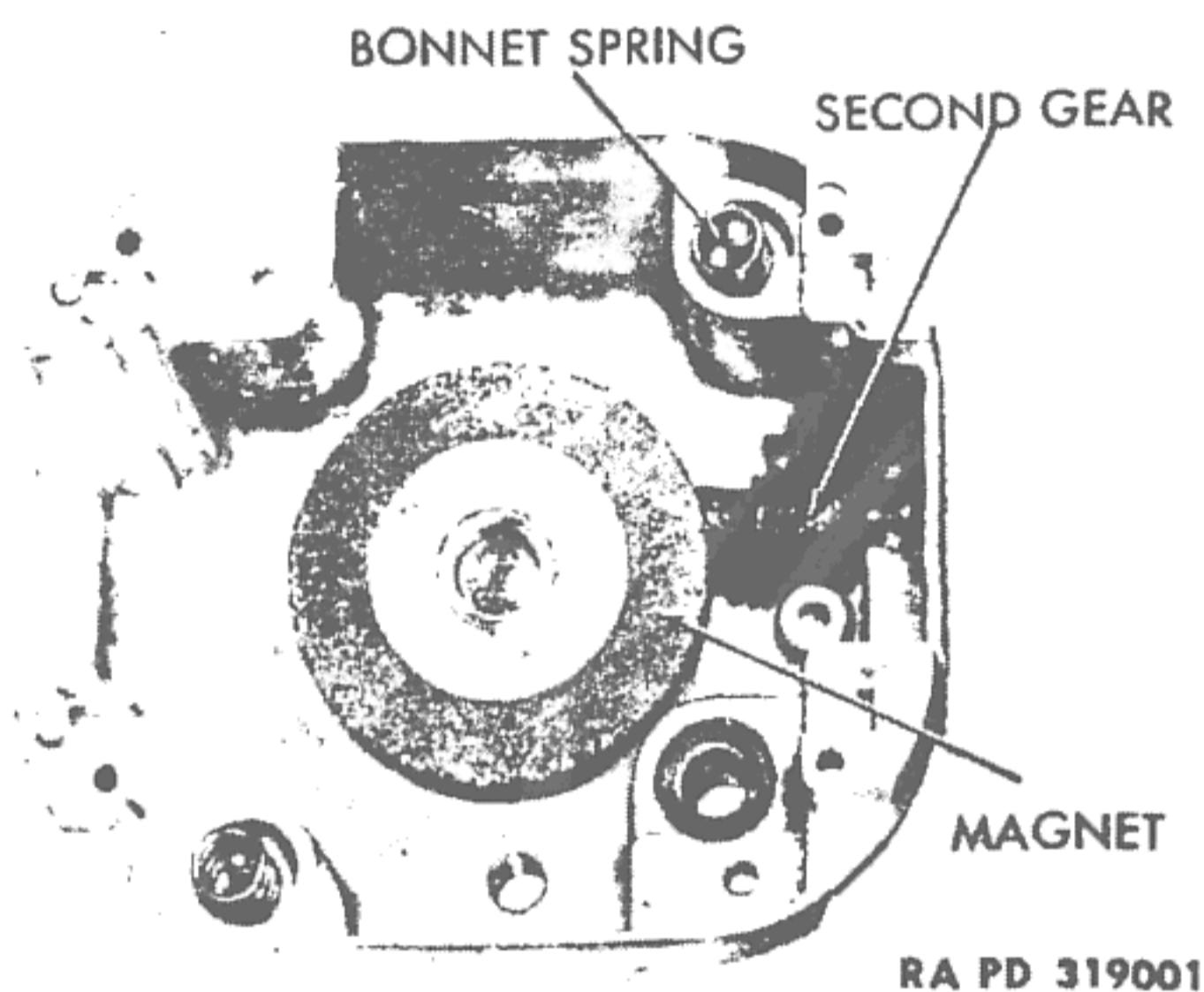

RA PD 319001

**Figure 116—Frame, Second Gear, and Magnet Assembly**

e. **Odometers.** Wipe dials clean with rag. Do not wash in dry-cleaning solvent, as lubricant will be removed. Inspect for free turning of dummy wheel on total odometer and tenth wheel on trip odometer. If odometers are "bound up" discard complete assembly.

f. **Dial Supports.** Inspect to see that they have not been bent in disassembly. If so, straighten.

## 44. ASSEMBLY AND CALIBRATION.

a. **Replace Oil Wick and Plug.** Saturate oil wick in watch and clock oil and place in frame. Using punch, tap oil wick into place (fig. 67).

b. **Replace Bonnet Assembly.** Place bonnet springs in recesses around corner posts of frame (fig. 116). (All new frames have an iron keeper on the magnet which must be removed before the bonnet is put on.) Place bonnet assembly on springs. Line up reset stem holes in frame and bonnet, taking care not to dislodge springs. Make sure that hair spring regulator arm is in correct position (fig. 114) and

**ORDNANCE MAINTENANCE  
SPEEDOMETERS, TACHOMETERS, AND RECORDERS**

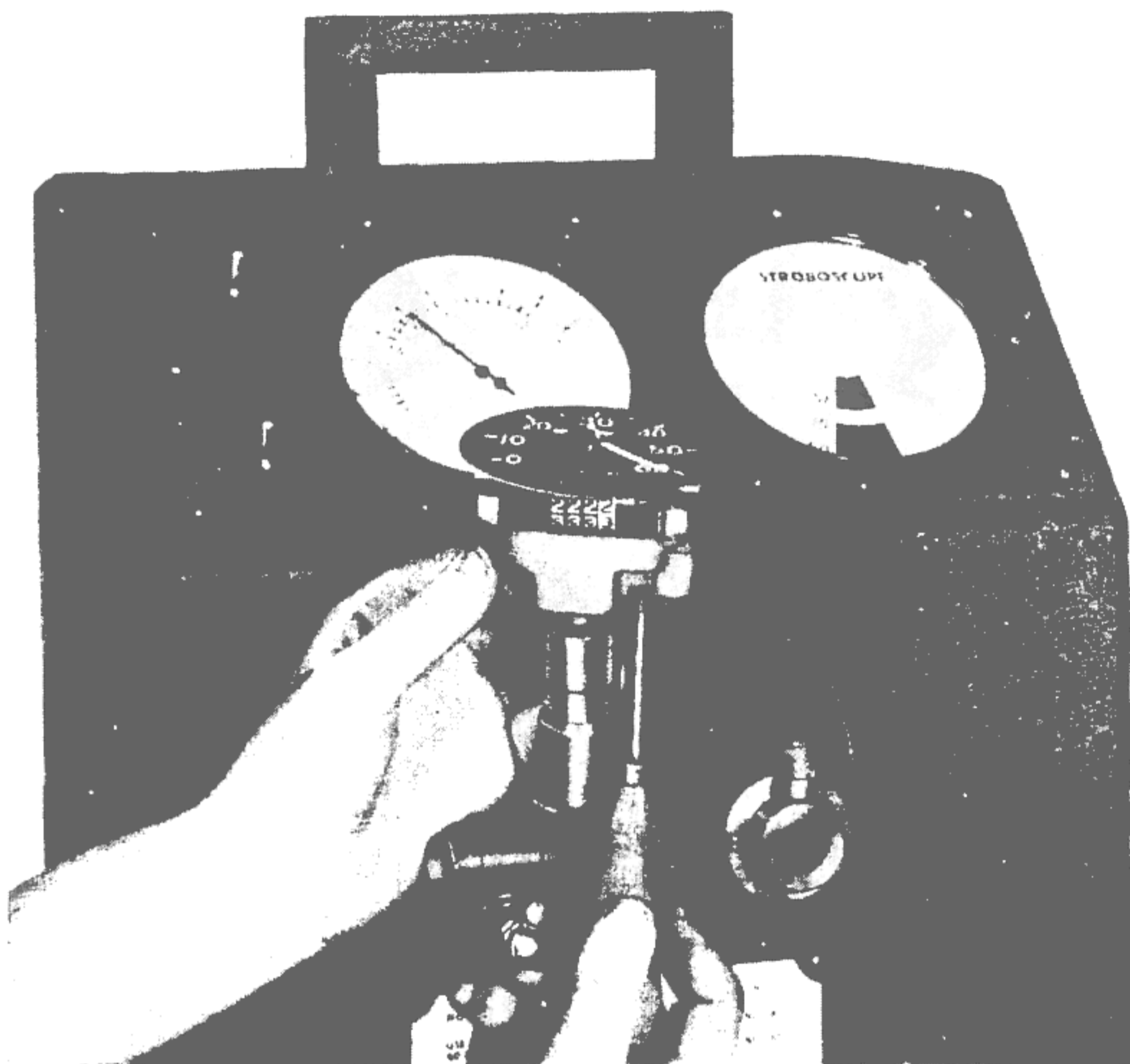

RA PD 319002

**Figure 117—Loosening Bonnet Adjusting Screws with  
Calibration Adjuster (STS-10878)**

that hair spring is properly adjusted (par. 43 b). Insert bonnet screws (fig. 115) and tighten.

c. **Replace Reset Shaft, Third Gear, Odometers, and Dial Supports** (fig. 114). Place reset shaft through hole in frame. Place small amount of No. 00 Grease, O.D. on teeth and bearing surfaces of third gear and place in frame. Place total odometer in frame in same position as before removal, so that mileage reading will be the same as before. If new odometer is installed or if old odometer has been turned back to zero, place in frame with zeros on top. Place reset spring, reset gear, and drive gear on trip odometer shaft and place assembly in frame. Place dial supports in position over locating pins making sure that upper end of third gear fits in hole in right-hand support and that hair spring regulator arm is above left support. Stake locating pins which protrude through the plate. If both sets of pins have been used, use four screws (Waltham No. 6161) to fasten

**WALTHAM SPEEDOMETERS**

dial supports to the frame. Test for free turning (par. 4 b). Test odometer reset mechanism.

**d. Replace Dial and Pointer.** Attach dial to supports with two screws. Start pointer on staff at 40-mile mark, and turn to zero while pressing on staff with thumb.

**e. Calibrate.** Place unit on calibrating machine, hold in approximately the same position as it will be on vehicle, run master head on machine at 10 miles per hour and, by moving hair spring regulator on speedometer up (if fast) or down (if slow) make it read the same as the master head. (This must be done before testing at other speeds.) Then run master at 60 miles per hour and, using special tool (T-189787—STS 10878), loosen the two bonnet adjusting screws evenly (by turning tool clockwise) until the speedometer indicates 60 miles per hour (fig. 117). Then check at 30 and 10 miles per hour. Bonnet adjusting screws should not be turned out more than  $1\frac{1}{2}$  turns. In exceptional cases the speedometer reading may be too high, even though adjusting screws are turned out  $1\frac{1}{2}$  turns. In such cases cut  $\frac{1}{2}$  coil from hair spring.

**f. Replace Case, Glass, Bezel, etc.** Place mechanism in case and fasten (two screws). Place glass retainer, glass, gaskets, and bezel in position and roll bezel (figs. 74 and 75). Place washers, spring, and knob on reset shaft.

ORDNANCE MAINTENANCE  
SPEEDOMETERS, TACHOMETERS, AND RECORDERS

## CHAPTER 8

STEWART-WARNER RECORDERS  
(INCLUDING HOURMETERS)

## 45. DESCRIPTION.

a. A recorder consists of an odometer assembly, a drive gear, and a driven gear housed in a die cast case. A female thread connection is provided at the left end of the recorder for attaching the flexible

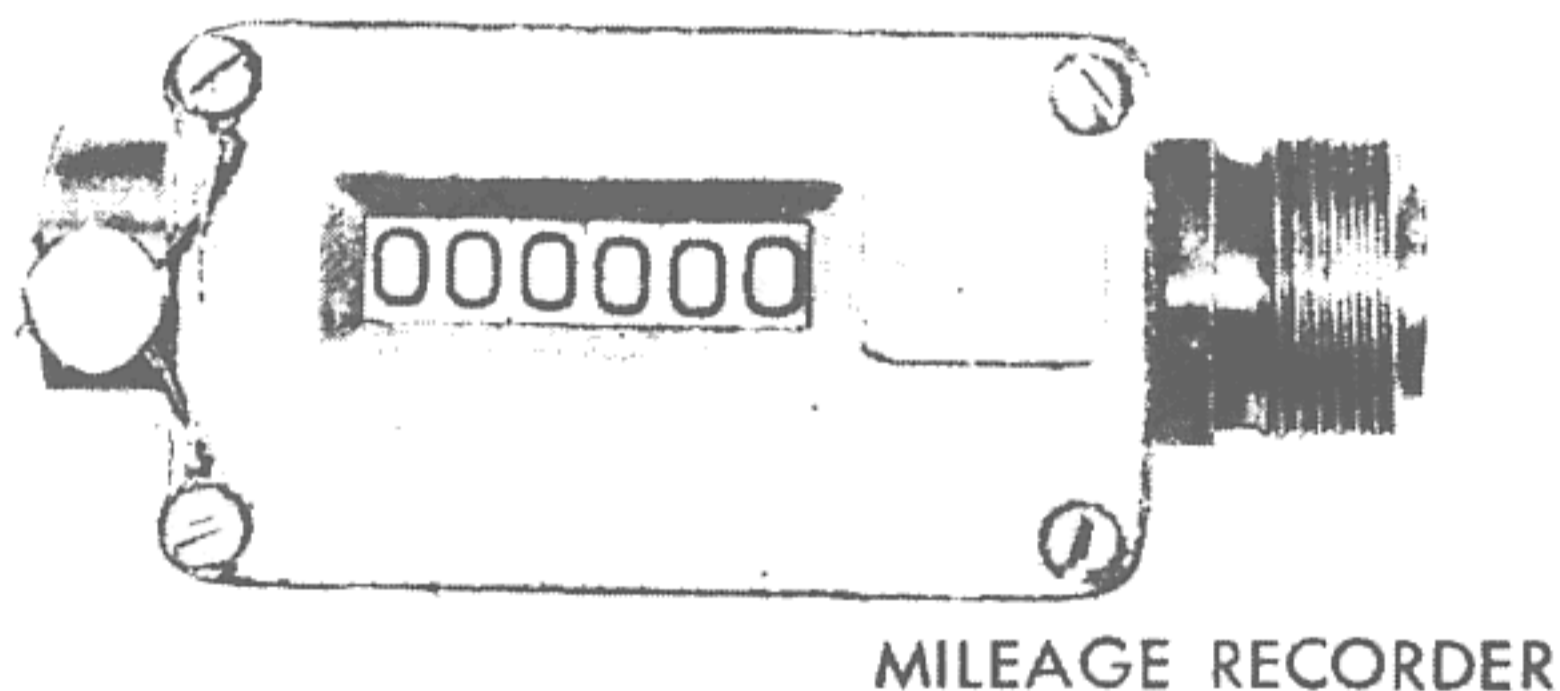
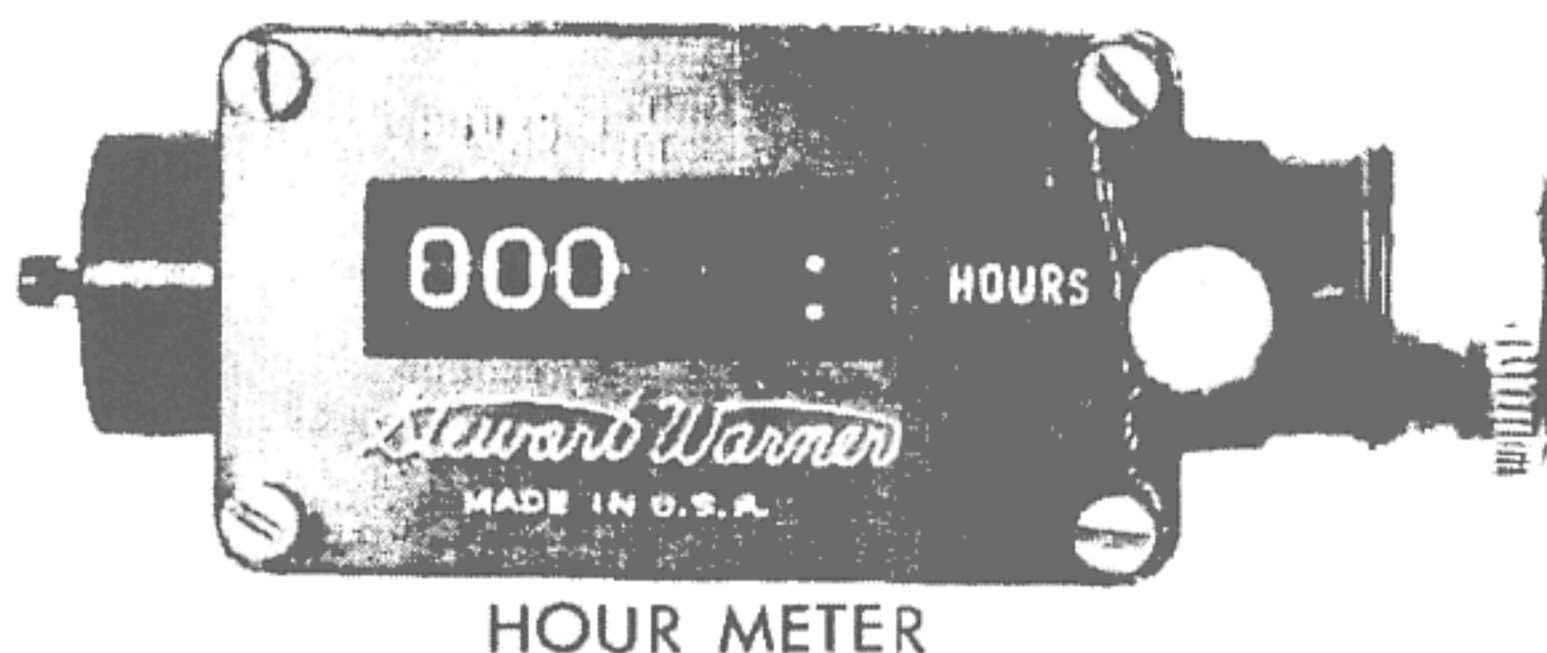

**Figure 118—Stewart-Warner Hourmeter and Mileage Recorder**

shaft. A male threaded sleeve is provided at the right end for connecting a flexible shaft leading to a tachometer, where desired. Recorders are used to accurately record engine motor mileage, wheel mileage, engine crankshaft revolutions, or hours of engine operation (based on average engine speed).

STEWART-WARNER RECORDERS

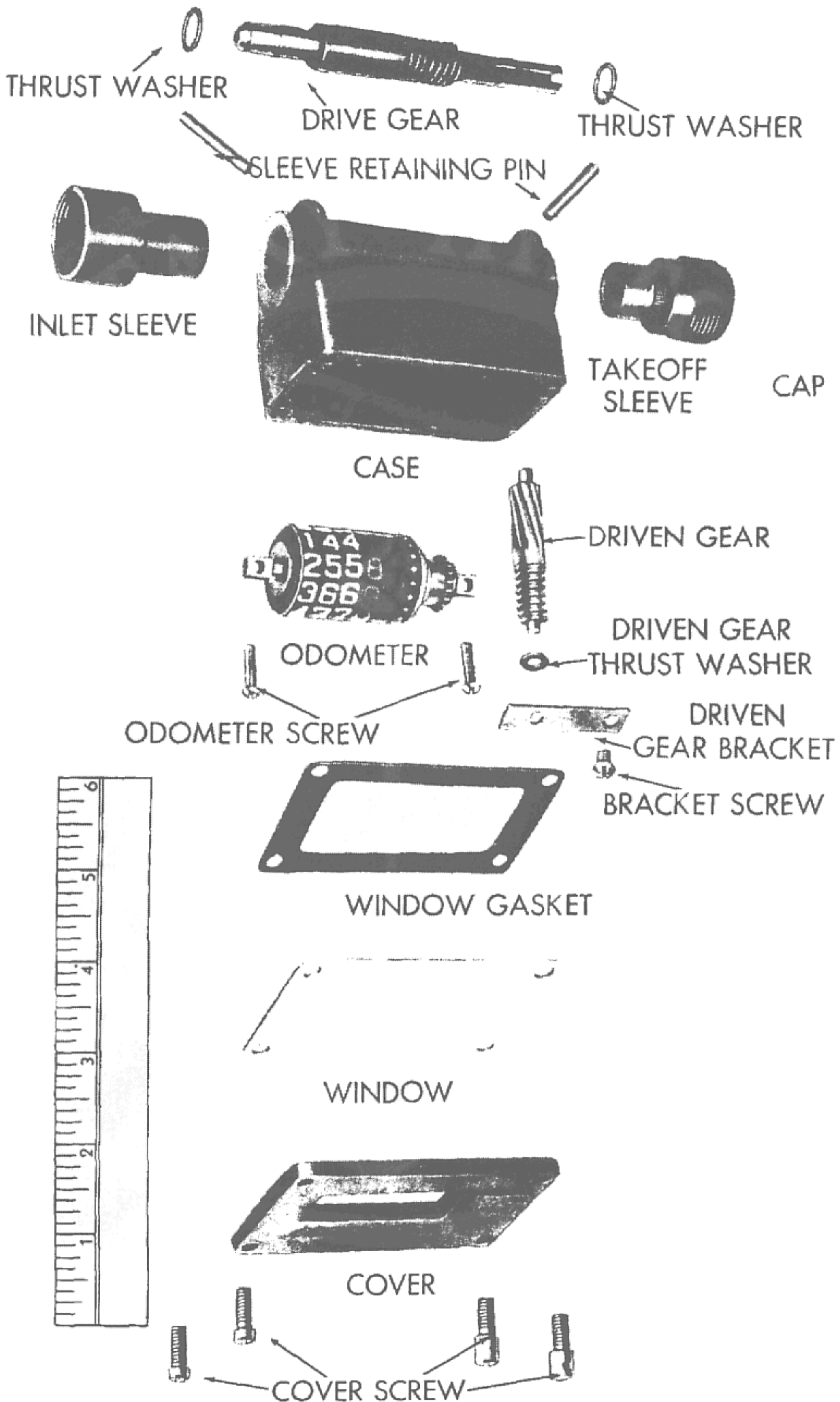

RA PD 319004

Figure 119—Stewart-Warner Recorder, Disassembled



## ORDNANCE MAINTENANCE SPEEDOMETERS, TACHOMETERS, AND RECORDERS

### 46. OPERATION.

a. The recorder is usually installed near the power take-off, and is connected to take-off by means of a flexible shaft. As the inner core of the shaft revolves, it turns the recorder drive gear. The drive gear turns the driven gear, which turns the odometer gear. This gear turns the odometer through a series of "star pinion" gears inside the odometer dials or figure wheels. As any one wheel finishes a complete revolution, it turns the next figure wheel to the left  $\frac{1}{10}$  of a revolution.

### 47. DISASSEMBLY.

a. **Remove Odometer and Driven Gear (fig. 120).** Remove four cover screws and lift off cover, window, and gasket. Remove driven

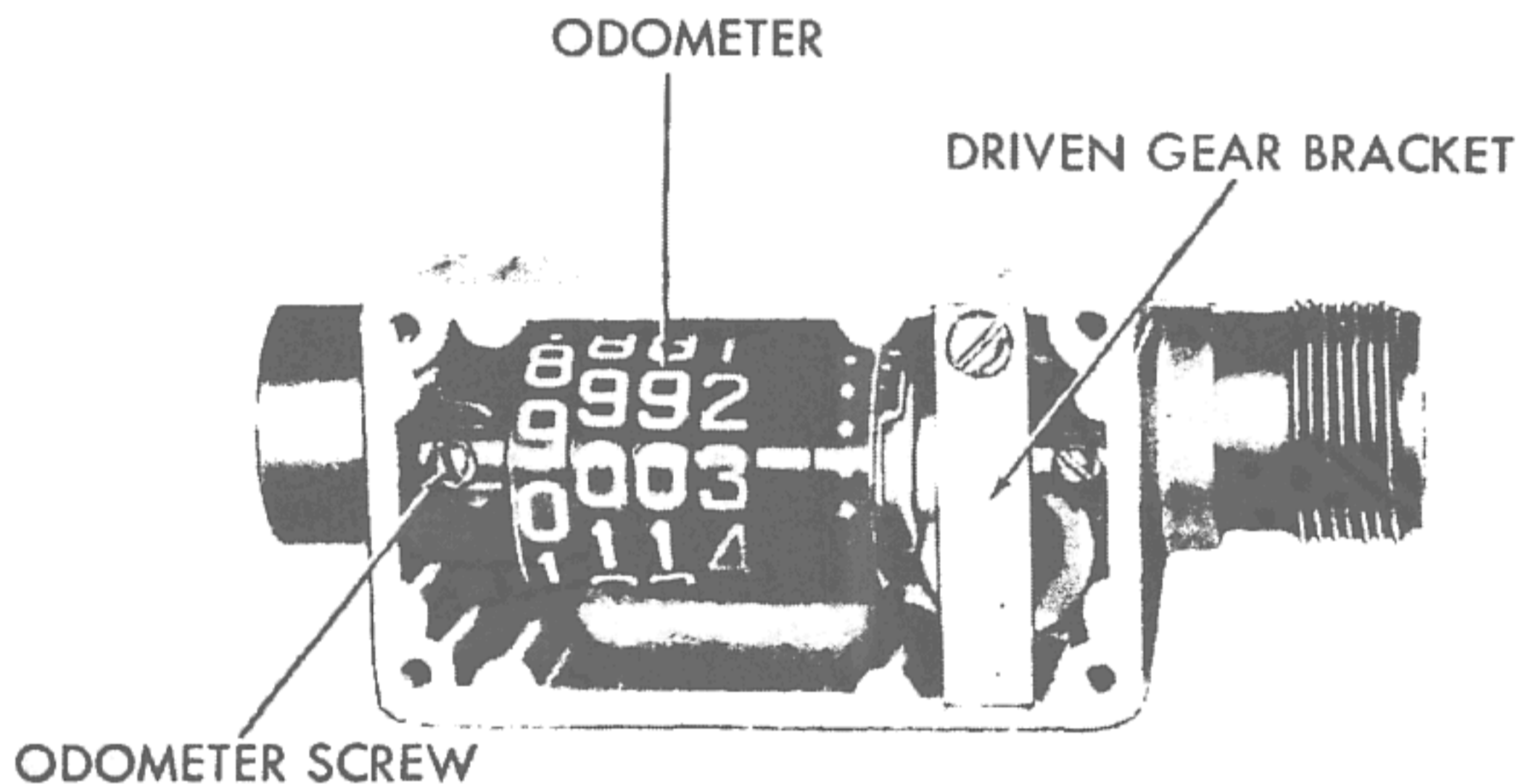

RA PD 319005

**Figure 120—Recorder with Cover Removed**

gear bracket screw, and lift off bracket and small washer on upper end of driven gear. Remove two screws, and lift out odometer assembly and driven gear.

b. **Remove Sleeves and Drive Gear.** Using punch (T-170742), drive out two sleeve retaining pins (fig. 121). Rest case on vise (do not tighten vise) and drive out male threaded sleeve (fig. 122). Then place female threaded sleeve down and, using punch (T-170742) in hole in end of drive gear, drive out this sleeve (fig. 122).

### 48. CLEANING, INSPECTION, AND REPAIR OF PARTS.

a. Thoroughly clean all parts (except odometer assembly, window, and gasket) with brush (T-170755) and a dry-cleaning solvent. Dry parts with compressed air. Inspect gear teeth, threads, and bear-

STEWART-WARNER RECORDERS



RA PD 319006

**Figure 121—Removing Sleeve Retaining Pin**

ing surfaces for excessive wear and defects. Wipe odometer figure wheels clean, but do not wash odometer in dry-cleaning solvent as this will remove lubricant. Inspect for free movement of figure wheels, and see that gear teeth are intact. If defective, discard complete odometer assembly.

**49. ASSEMBLY.**

a. **Replace Drive Gear and Sleeves.** Place thrust washers over each end of drive gear. Lubricate with small amount of No. 00 Grease, O.D. and place in case. Start sleeves in place, making sure that gear and sleeves are in correct position (fig. 119) and that slots in sleeves line up with pin holes in case. Place assembly on arbor press and squeeze sleeves into case (fig. 123). Using small hammer, drive pins into holes.

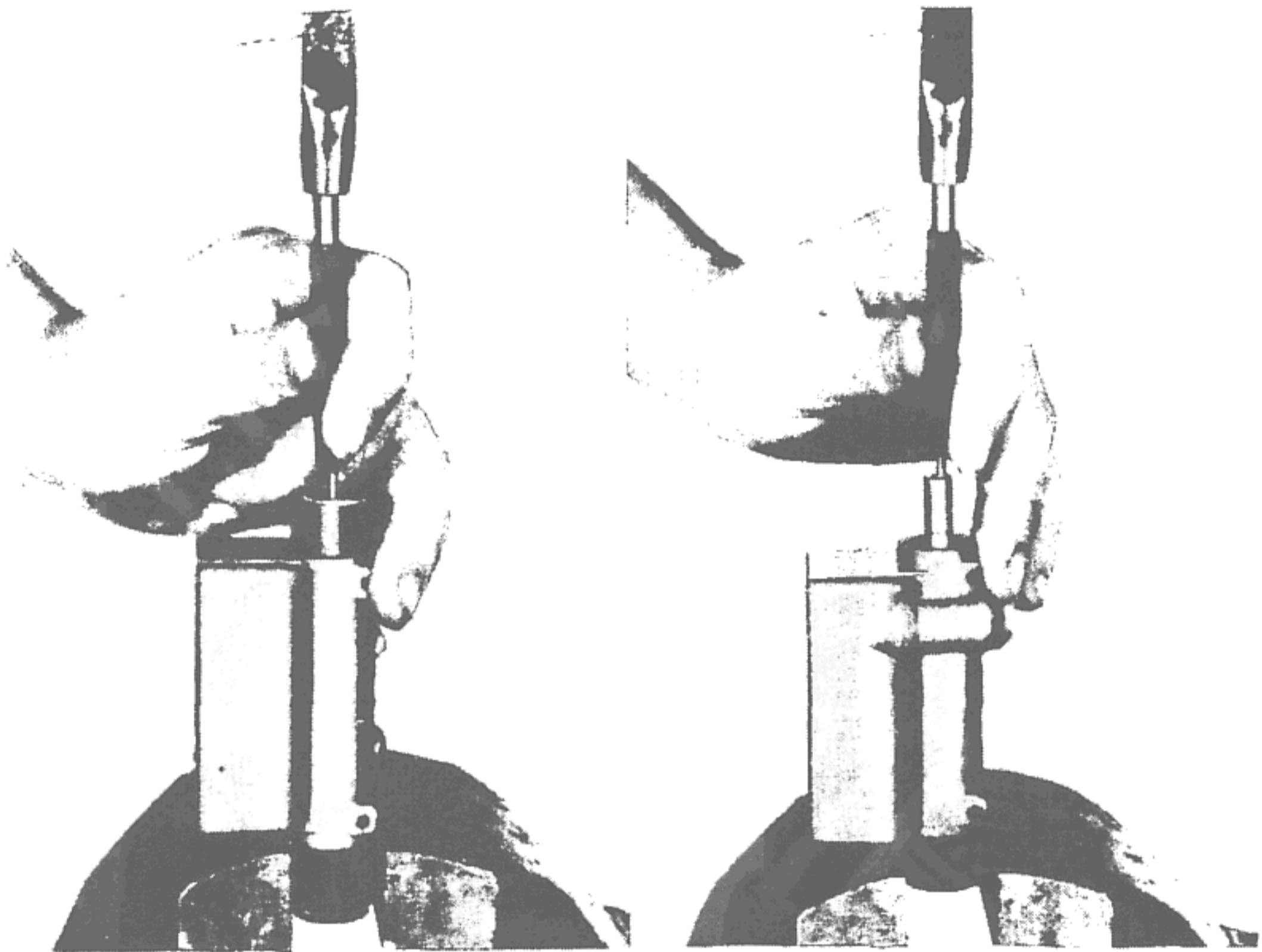
**ORDNANCE MAINTENANCE  
SPEEDOMETERS, TACHOMETERS, AND RECORDERS**

RA PD 319007

**Figure 122—Driving Out Sleeves**

b. **Replace Driven Gear, Odometer, and Cover.** Lubricate driven gear with small amount of No. 00 Grease, O.D., and place in case. Place odometer in case with flat side of shaft down and fasten with two screws. Place small washer over upper end of driven gear, insert gear bracket and fasten with screw. Test for free turning. Replace gasket, window, and cover, and fasten with four screws.

**STEWART-WARNER RECORDERS**

*http://jeepdraw.com*  
*FREE DOWNLOAD*  
*Thanks to G503.com*  
*Jon Rogers & Pete Silfven*

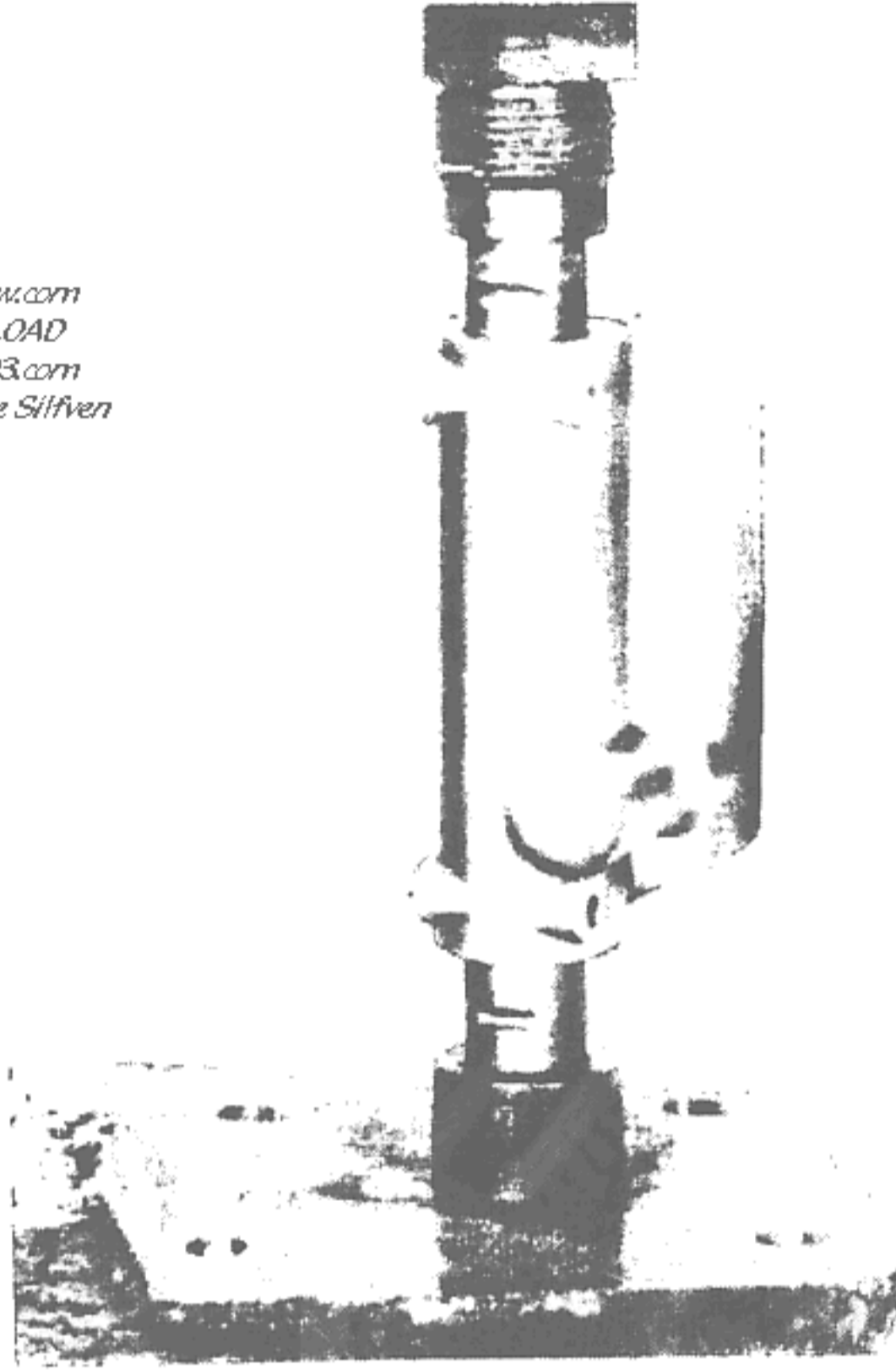

RA PD 319008

**Figure 123—Pressing Sleeves into Case**

ORDNANCE MAINTENANCE  
SPEEDOMETERS, TACHOMETERS, AND RECORDERS

CHAPTER 9  
FLEXIBLE SHAFTS

*http://jeepdraw.com*  
FREE DOWNLOAD  
Thanks to G503.com  
Jon Rogers & Pete Silfven

50. DESCRIPTION.

a. A complete flexible shaft (fig. 124) consists of two major assemblies: (1) A flexible outer casing with nuts and ferrules at both ends. The casing diameter and the connecting nuts vary for different applications and instruments. (2) A wire-wound flexible inner core assembly with squared ends or crimped-on tips. The core diameter and end connections vary for different applications. There are only two diameters of flexible inner cores used in army vehicles. Passenger cars and light trucks use 0.130-inch diameter. Heavy trucks, gun carriers, and tanks use 0.150-inch diameter. Small cores (0.130-in. diameter) are supplied with self-contained tips which are formed by squaring the ends in suitable dies. Large cores (0.150-in. diameter) have keyed metal tips crimped on the lower end, and a squared tip crimped on the upper end.

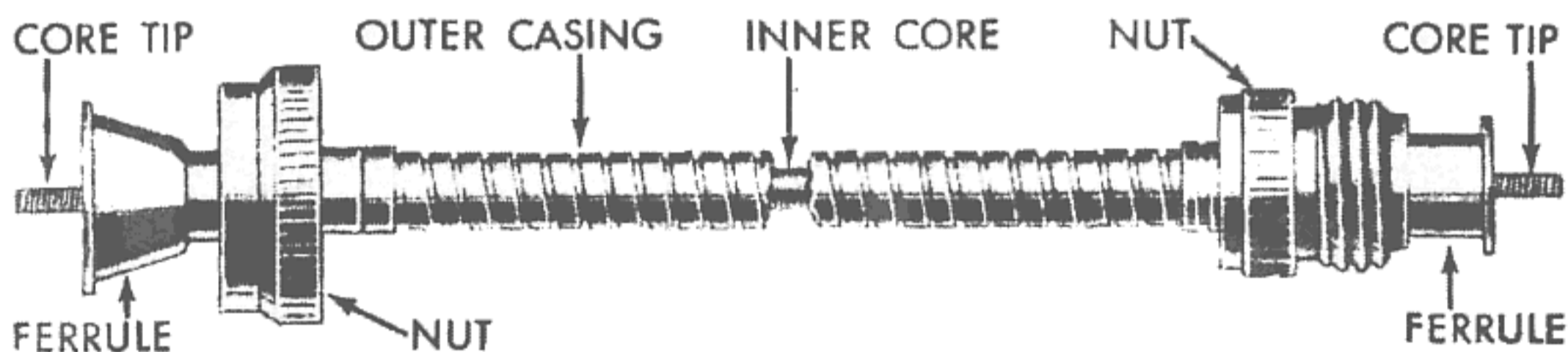

Figure 124—Flexible Shaft

RA PD 319009

51. OPERATION.

a. One end of the flexible shaft is attached to the instrument (speedometer, tachometer, or other recorder) and other end is attached to the transmission or other power take-off point. The flexible inner core transmits the power from the take-off, while the outer casing is held rigidly in place at each end by the ferrules and nuts.

52. REPAIR OF FLEXIBLE SHAFTS.

a. **Inner Core.** Pull old core out of casing. Check removed unbroken core for kinks by rolling on a flat surface. If a flat surface is not available, take an end in each hand and roll core between fingers. In either case a core kink will show up as a "hop" at the kinked point. Do not reuse a kinked core, because it will cause fluctuation of the speedometer or tachometer pointer. Check removed core for frayed spots by running it loosely through your fingers. Do not reuse a frayed cable. Kinks and frayed spots in a core usually indicate a casing with very sharp bends. Any casing with less than 6-inch

## FLEXIBLE SHAFTS

radius bends should have the clips removed and the bends relieved. Also check for crushed casing due to retaining clamps being assembled too tight.

(1) **MEASURE OLD CORE.** Straighten out bends (if old core is broken straighten out bends in both sections). Lay old core on flat surface and measure as follows:

(a) *Core with Both Ends Squared* (A, fig. 125). Measure over-all length.

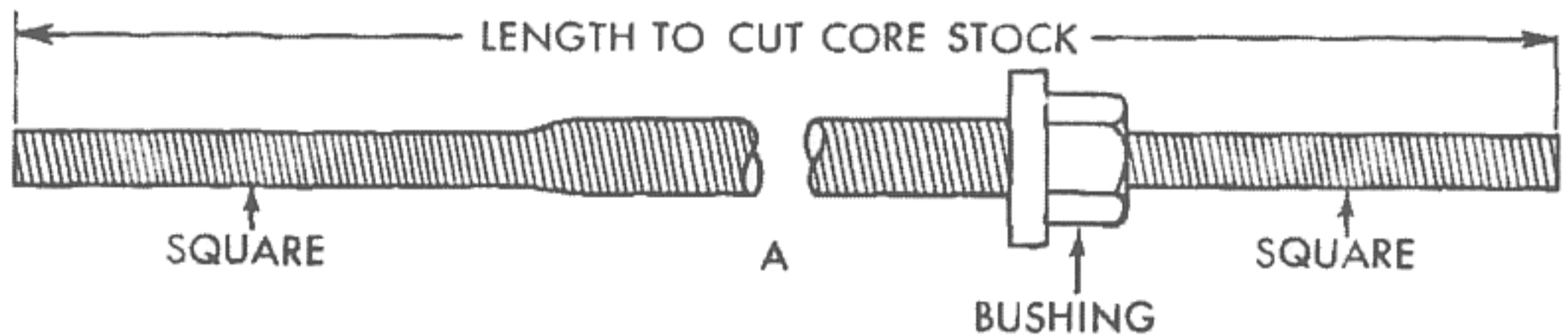

<http://jeepdraw.com>  
FREE DOWNLOAD  
Thanks to G503.com  
Jon Rogers & Pete Silfven

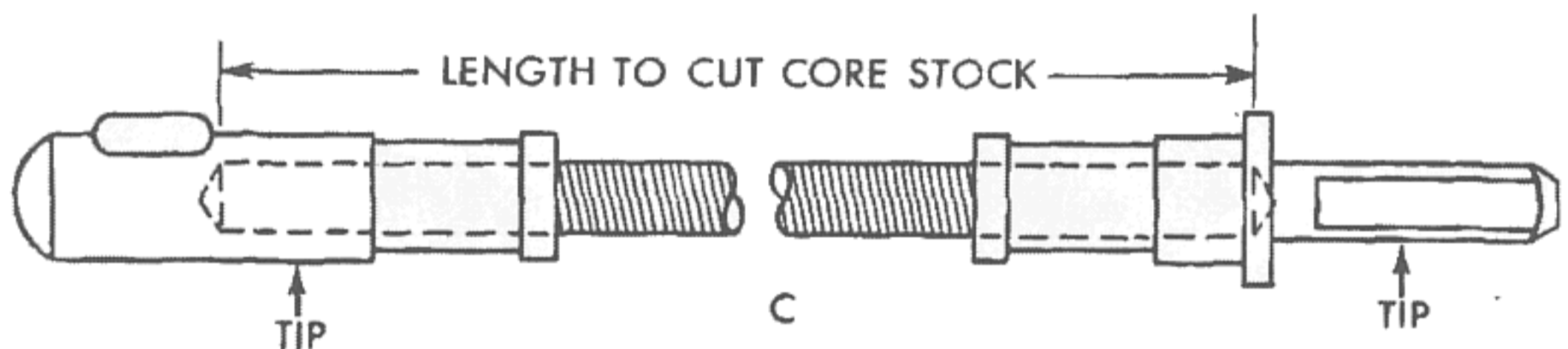
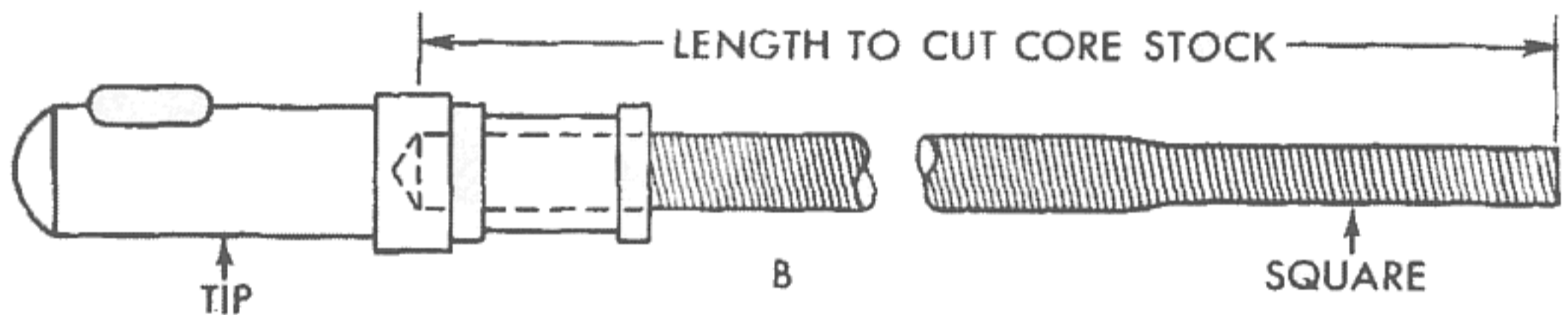

RA PD 319010

**Figure 125—Drawing Showing Length to Cut Core Stock**

(b) *Core with One End Squared and Tip on Other End* (B, fig. 125). Secure new tip similar to old one, and measure depth of hole. Measure visible length of old core and add depth of hole.

(c) *Core with Tip on Both Ends* (C, fig. 125). Secure new tips like those on old core. Measure depth of hole in each tip, measure visible length of old core and add depths of holes.

(d) If the over-all dimensions of the core to be replaced cannot be determined, then it will be necessary to measure the casing with which it is to be used. Ordnance standard core assemblies for both diameter casings should be made  $1\frac{1}{8}$  inches longer over-all than the

## ORDNANCE MAINTENANCE SPEEDOMETERS, TACHOMETERS, AND RECORDERS

distance between the casing ferrule ends. This measurement will be exact for small core on which the ends are to be squared, but on the large-diameter core consideration must be given to amount of core insertion in each tip, plus the remaining tip length. Squared tip core must have a retaining collar crimped at the upper or speedometer

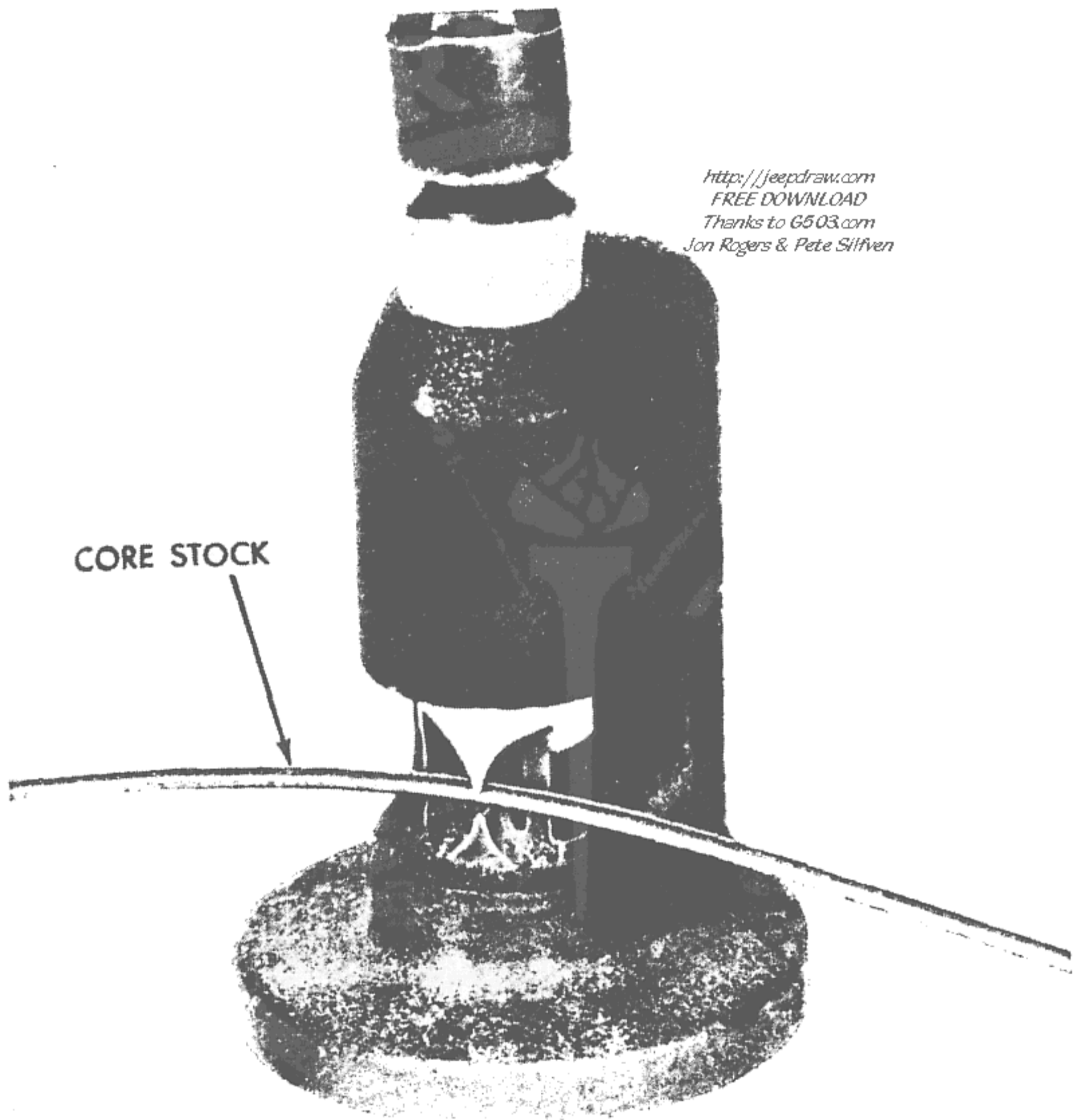

*http://jeepdraw.com  
FREE DOWNLOAD  
Thanks to G503.com  
Jon Rogers & Pete Silfven*

RA PD 319011

**Figure 126—Cutting Core Stock, Using Fixture (T-136374)**

end. The location of this collar should be  $6\frac{1}{64}$  inch from the underside of the tip collar to the end of the squared core. Upper tips always have this collar formed as an integral part. The collar keeps the core from falling into the casing and disengaging from the speedometer.

(2) **CUT NEW CORE.** After determining over-all length of old core, cut same length from new bulk core stock of same diameter as

## FLEXIBLE SHAFTS

old core. This is done by fixture (T-136374) (fig. 126). Grind off any burrs on end of core stock. **NOTE:** *Never cut new core to longer length than old core. However, new core may be slightly shorter than old core.*

(3) **MAKE UP NEW CORE END CONNECTIONS.** Make up new core end connections identical to those on old core as follows:

(a) *Squaring End of Inner Core* (fig. 127). Using fixture (T-136374), insert proper length of core end between proper squaring dies (refer to old core). Hold core firmly, keeping portion to be squared in a horizontal position. Using heavy hammer, strike hard blow on fixture to start squaring operation. Turn core  $\frac{1}{4}$  turn in die.

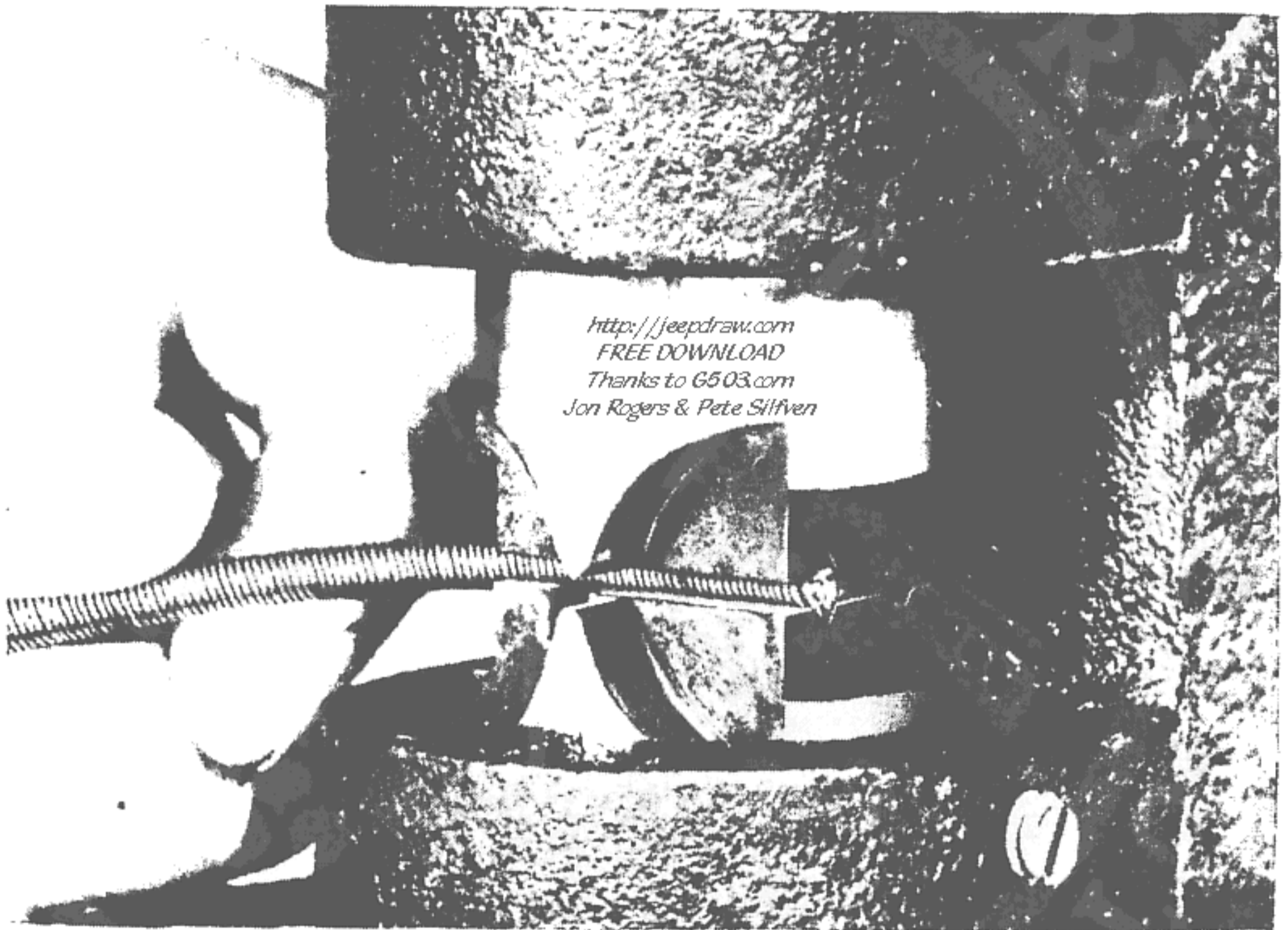

RA PD 319012

**Figure 127—Squaring End of Inner Core, Using Fixture (T-136374)**

and again strike fixture hard blow with hammer. Repeat these operations until end of core is sufficiently squared.

(b) *Crimping on Bushing.* On inner cores where the upper end is squared (step (1) above), a bushing (fig. 125) is used to hold squared end of core into neck of instrument. Place bushing in proper location on end of core. Bushing is usually located at the end of the square formation, and the measurement can be taken from the old core assembly (par. 52 a (1) (d)). Using fixture (T-136374), insert bushing between upper and lower crimping die, hold core firmly and, using heavy hammer, strike hard blow on fixture. Remove from die and check to see that bushing is securely crimped to inner core.



ORDNANCE MAINTENANCE  
SPEEDOMETERS, TACHOMETERS, AND RECORDERS

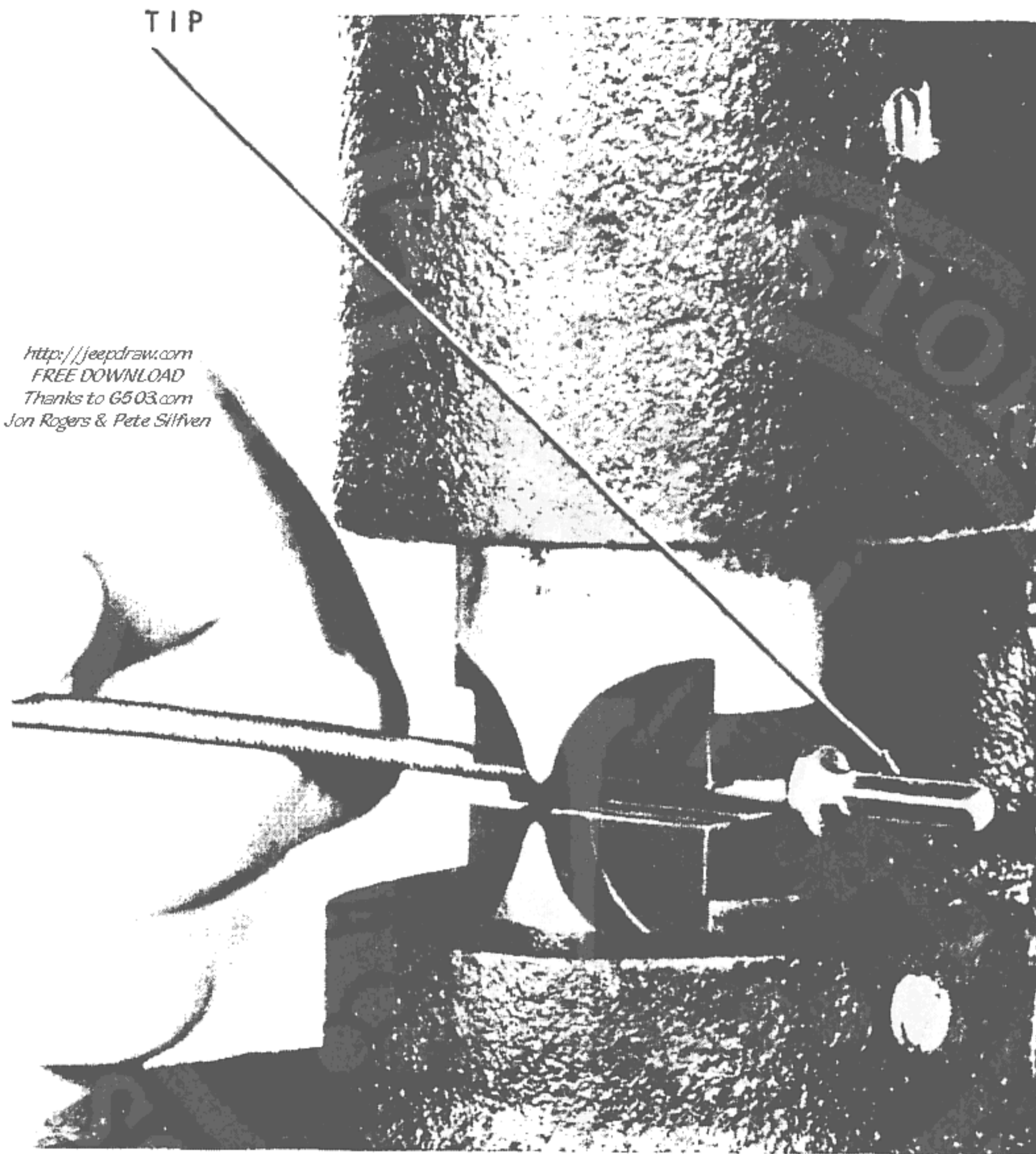

RA PD 319013

Figure 128—Crimping Tip on Inner Core, Using Fixture (T-136374)

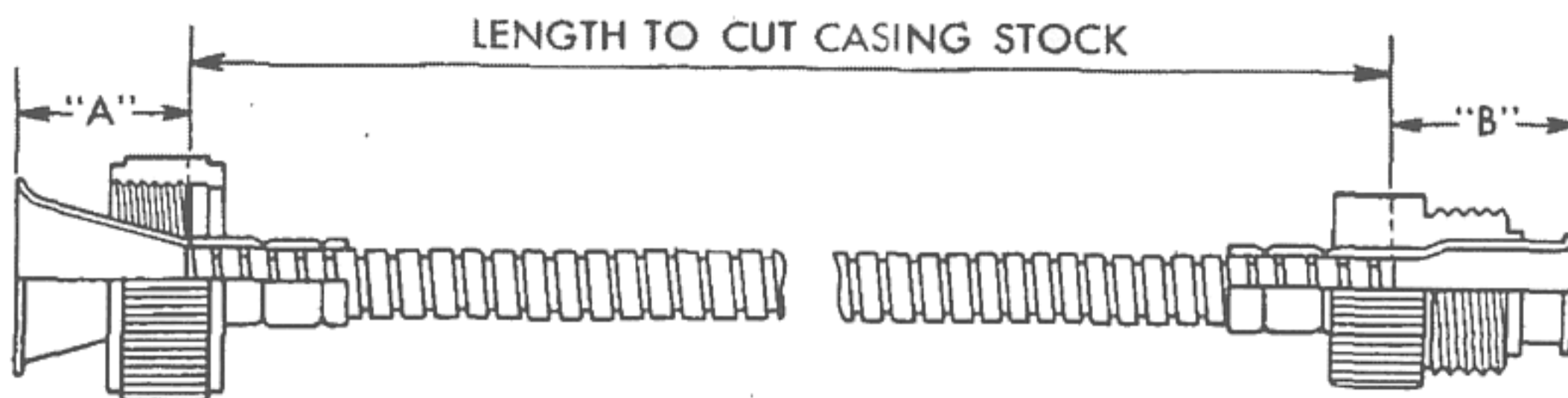

RA PD 319014

Figure 129—Drawing Showing Length to Cut Casing Stock

**FLEXIBLE SHAFTS**

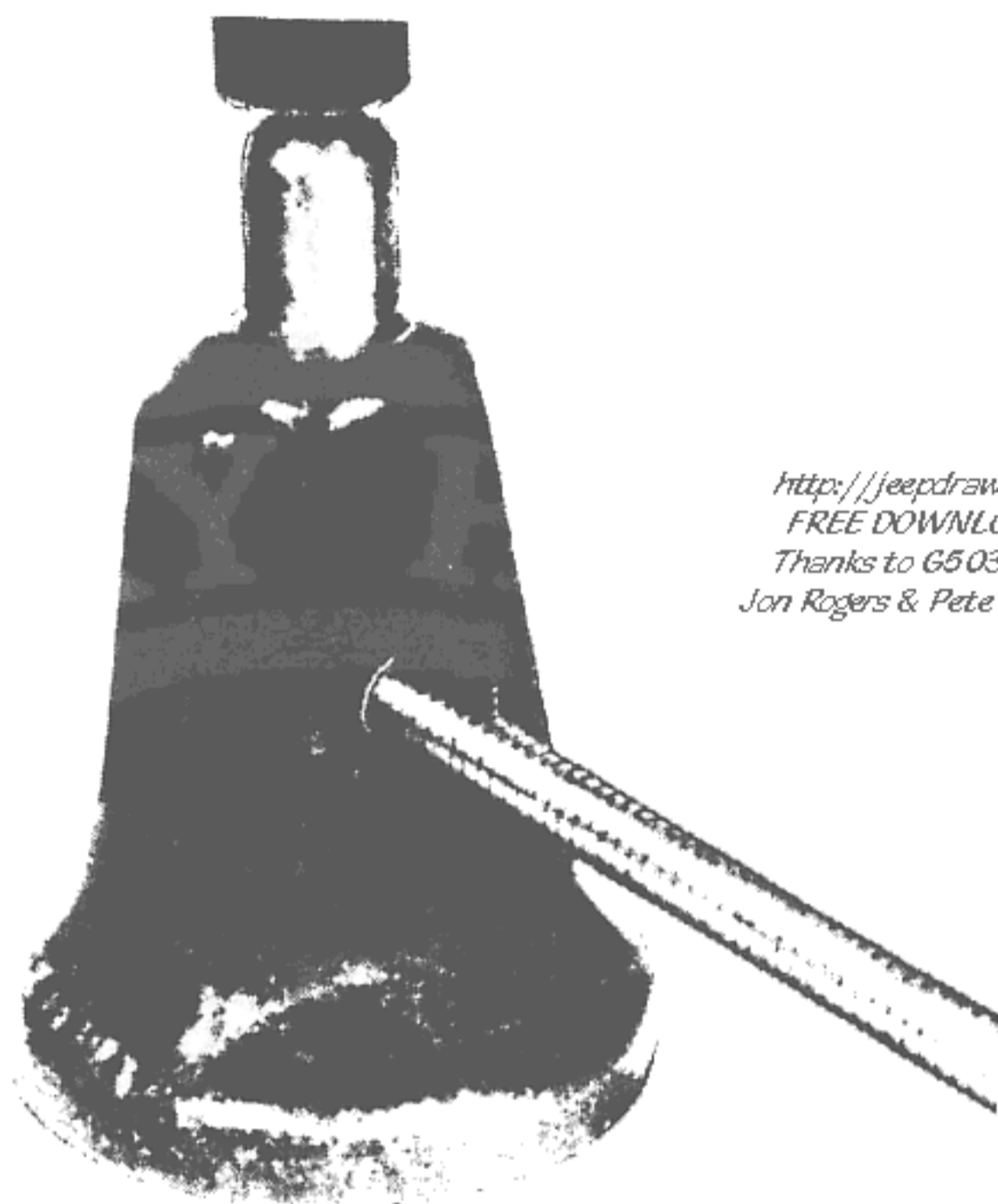

*http://jeepdraw.com  
FREE DOWNLOAD  
Thanks to G503.com  
Jon Rogers & Pete Silfven*

RA PD 319015

**Figure 130—Crimping Ferrule, Using Fixture (T-52644)**

(c) *Crimping on Tip* (fig. 128). Insert end of core into proper tip. Core tips are supplied in a variety of shapes and sizes. In selecting a replacement tip, always check length, shape, outside diameter, and hole inside diameter against the old tip. Using large jaws of fixture (T-136374), place tip between upper and lower crimping die, hold core firmly and, using heavy hammer, strike hard blow on fixture. Repeat crimping operation with tip in different position.

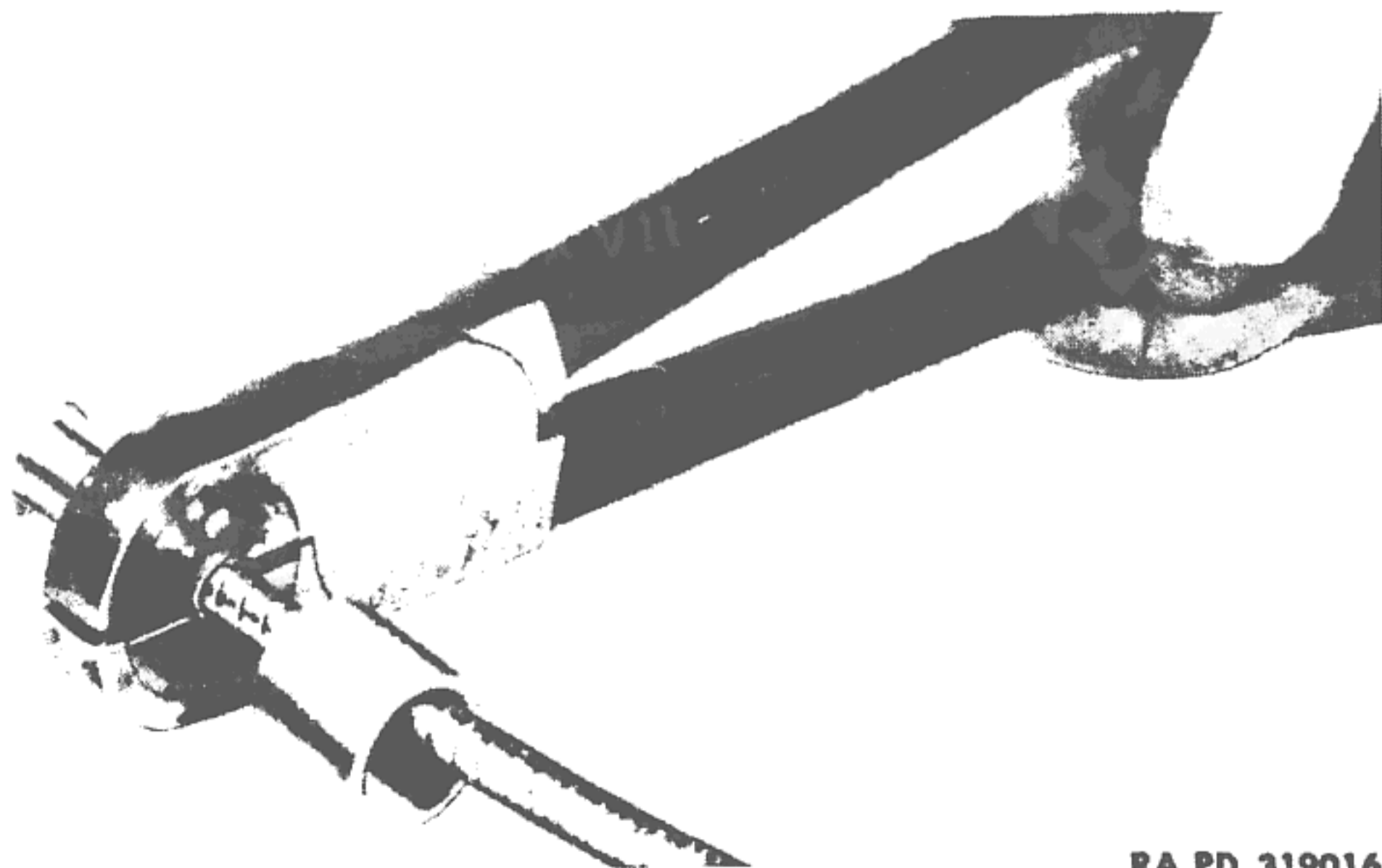

RA PD 319016

**Figure 131—Crimping Ferrule, Using Pliers (T-122308)**

**ORDNANCE MAINTENANCE  
SPEEDOMETERS, TACHOMETERS, AND RECORDERS**

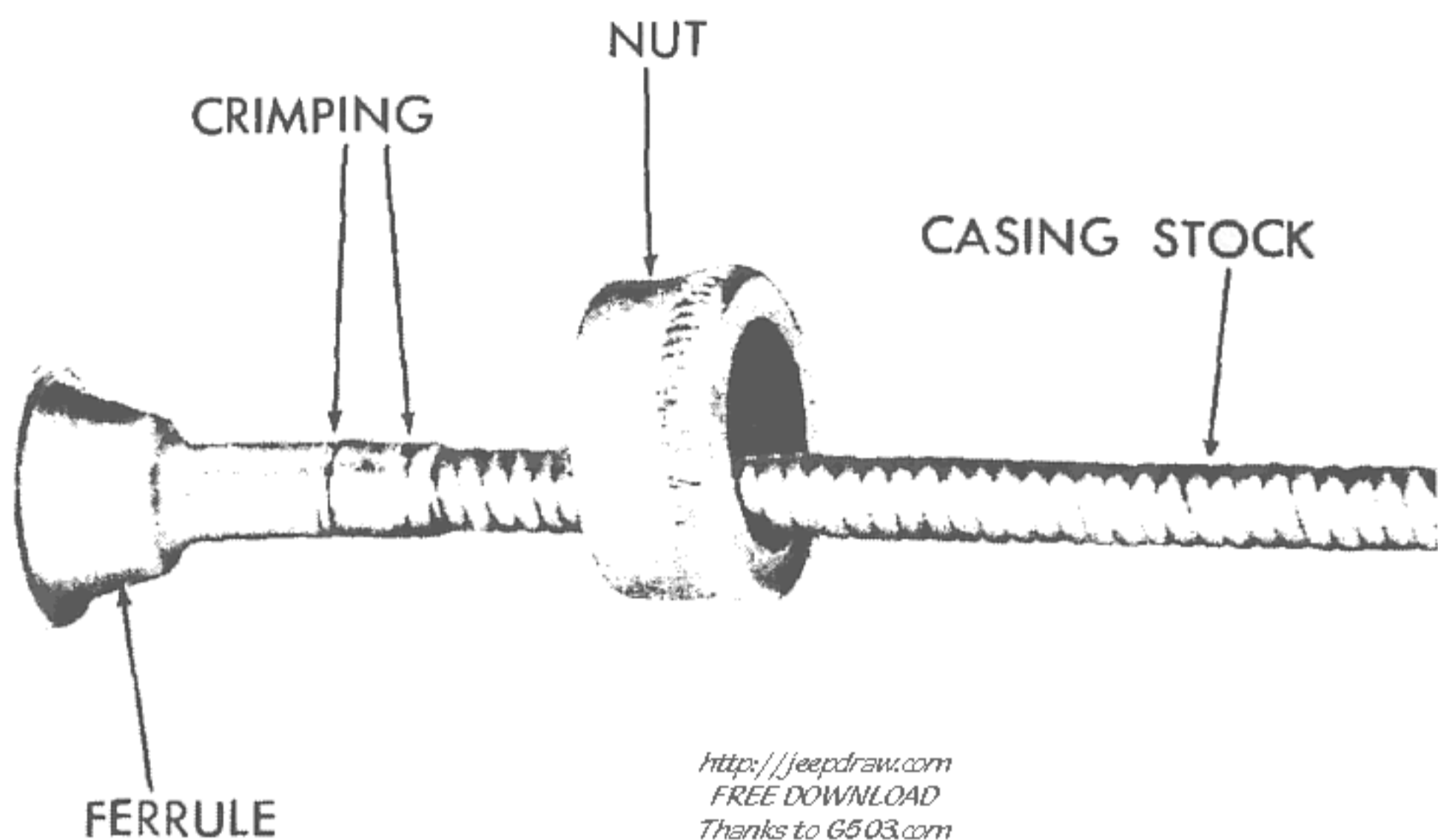

RA PD 319017

**Figure 132—Ferrule Crimped on Casing**

Remove from die and test for firm crimp. Squaring and tip-crimping require extreme care so that the operation will result in the tip being concentric with the core. Only a small amount of tip eccentricity will result in faulty speed indication. Care must be taken to prevent unraveling or fraying of squared core ends. Frayed ends can be touched up on a fine grinding wheel by rotating core on grinding wheel in direction of outer wire spiral.

b. **Outer Casing.** Straighten out old casing assembly with hands only (never use hammer). Examine carefully and replace if threads

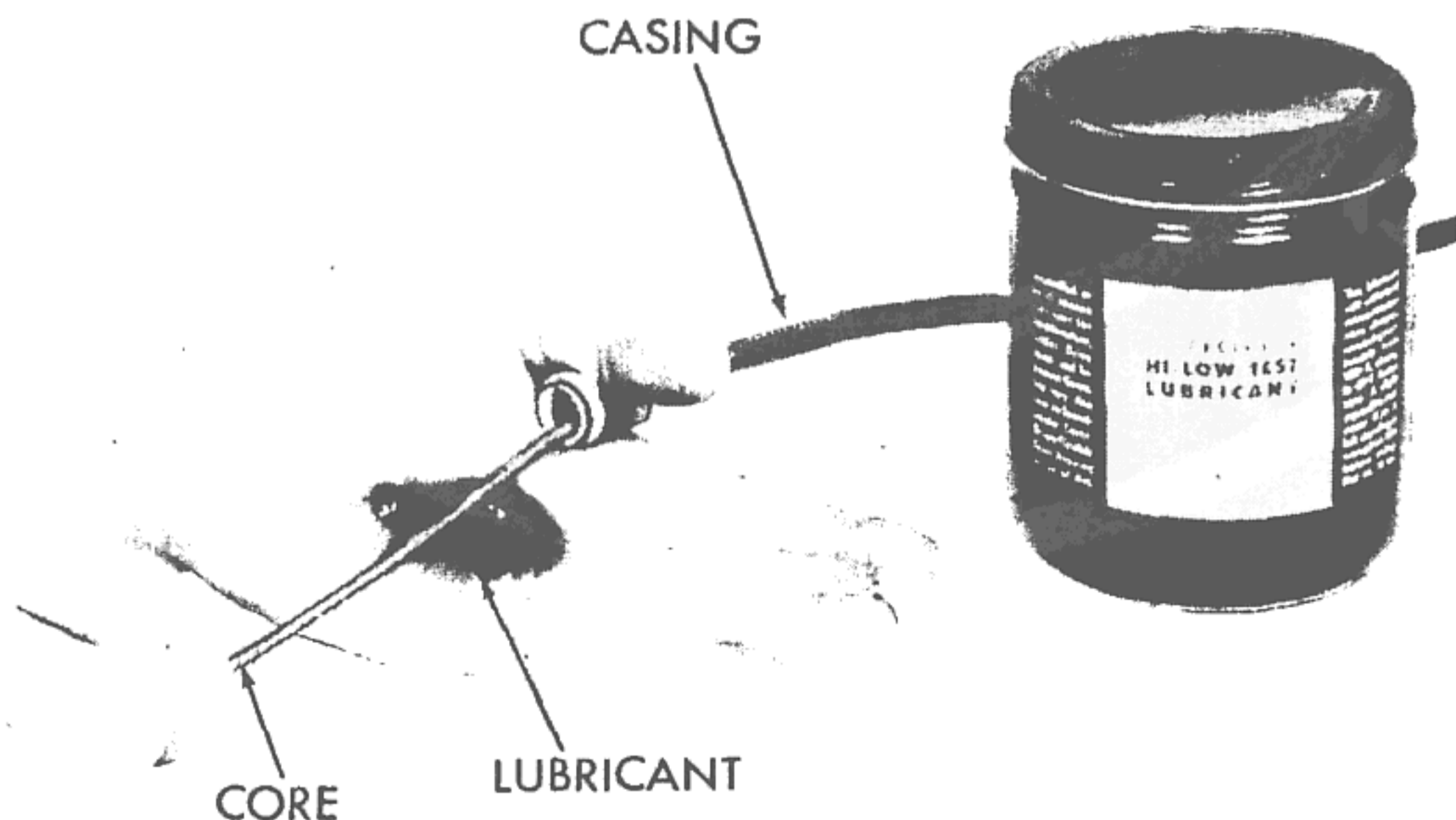

RA PD 319018

**Figure 133—Lubricating Inner Core as It Is Assembled to Casing**

## FLEXIBLE SHAFTS

on nuts are badly worn or stripped, if ferrule is damaged, or if casing stock is kinked, stretched, or otherwise defective. If casing must be replaced proceed as follows:

(1) **MEASURE OLD CASING.** Lay old casing on flat surface and measure over-all length. Determine length of casing stock by subtracting dimensions A and B (fig. 129).

(2) **CUT NEW CASING.** Select proper size casing stock and, using hacksaw, carefully cut off proper length for casing being made up. Grind off any burs on ends of casing stock.

(3) **ATTACH FERRULES.** Using old casing assembly as a guide, insert new casing stock into new ferrules, making certain that nuts are in place.

(a) *For 0.445-inch O.D. or Larger Casing Stock* (fig. 130). Using fixture (T-52644), place ferrule between upper and lower crimping die, hold casing firmly and, using hammer, strike solid blow on fixture. (Caution must be used to prevent collapsing the casing.) Repeat the above while turning casing and ferrule until a ring is crimped completely around the ferrule. Then move ferrule in dies and crimp another ring as described above (fig. 132).

(b) *For 0.243-inch and 0.297-inch O.D. Casing Stock* (fig. 131). Using pliers (T-122308), place ferrule between jaws, squeeze plier handles and turn casing and ferrule assembly until ring is crimped completely around ferrule. Then move ferrule in pliers and crimp another ring as described above.

c. **Assemble Flexible Shaft.** Spread a thin coat of No. 00 Grease, O.D. evenly over lower two-thirds of core only. This is best done by placing about a tablespoonful of lubricant in palm of hand, holding instrument end of casing in same hand with lubricant, and feeding core (lower end first) through lubricant and into casing (fig. 133). **CAUTION:** *Never fill the casing with grease.*

*http://jeepdraw.com  
FREE DOWNLOAD  
Thanks to G503.com  
Jon Rogers & Pete Silfven*

## CHAPTER 10

### AC SPEED ADAPTERS

#### 53. FUNCTION.

a. Ordinarily the vehicle manufacturer compensates for variations in tire size and rear axle ratio by the installation of corresponding speedometer drive and driven gears in the transmission. However, in some cases a speed adapter installation is desirable to eliminate special gear cutting or to achieve greater speedometer accuracy. In some cases 1 : 1 ratio right angle adapters are used at the transmission to avoid a sharp bend in the flexible shaft.

#### 54. APPLICATION.

a. It is sometimes necessary to make service installations of speed adapters to compensate for changes made in rear axle ratio or tire size. See speed adapter chart for various ratio adapters, selecting the ratio closest to whatever is required. The following information is required to figure the correct speed adapter ratio:

- (1) Tire outside diameter.
- (2) Rear axle ratio.
- (3) Number of teeth in transmission speedometer drive and driven gears.

#### 55. DISASSEMBLY, REPAIR, AND ASSEMBLY.

a. Generally it is not economical to repair a speed adapter when more than one of the gears or the housing is damaged. Straighten tangs on bearing plug lock washer. Remove two bearing plugs which will allow disassembly of lock washer, drive gear (shaft bearing

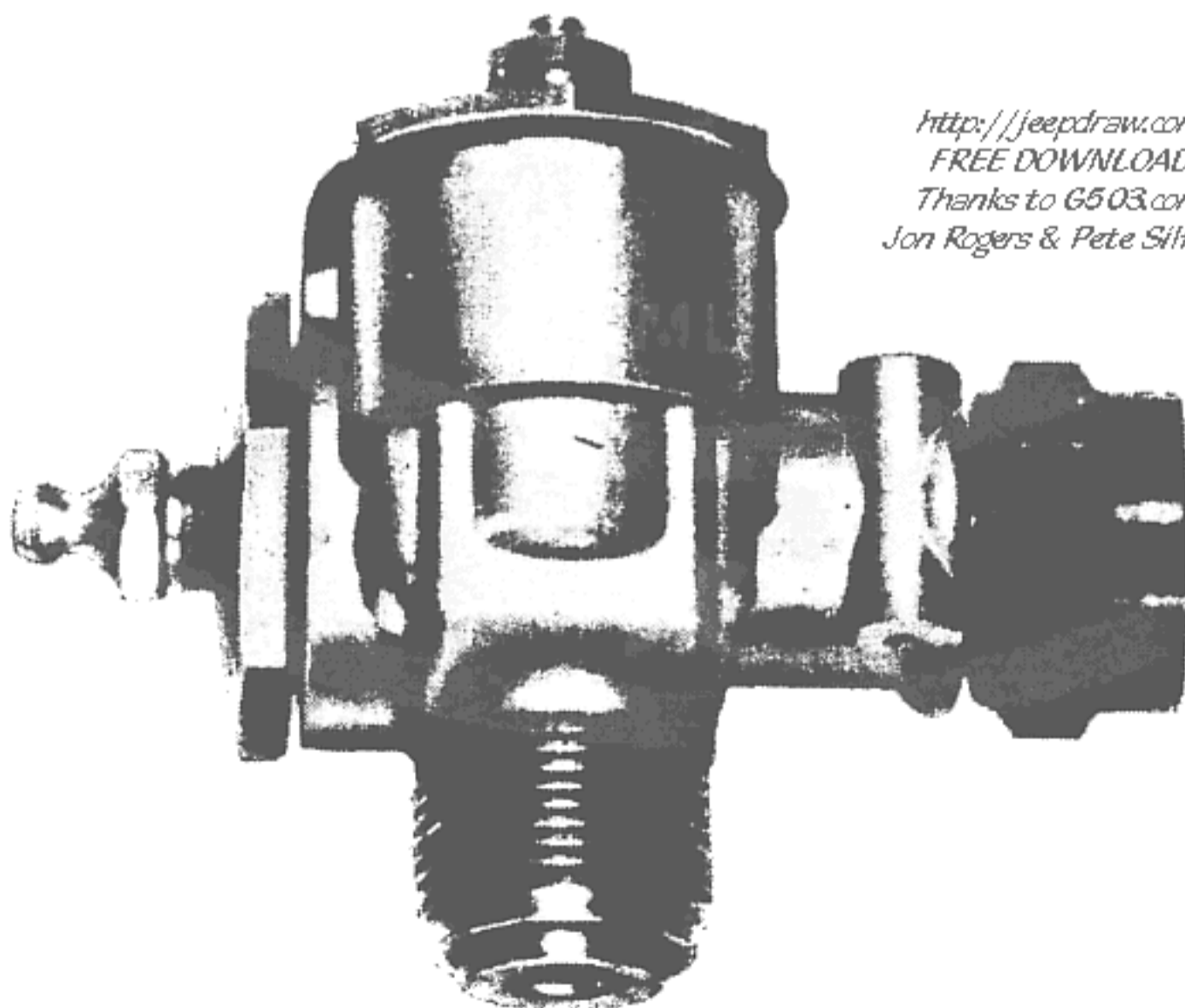

*http://jeepdraw.com  
FREE DOWNLOAD  
Thanks to G503.com  
Jon Rogers & Pete Silfven*

RA PD 319019

**Figure 134—AC Heavy-duty Speed Adapter**

**AC SPEED ADAPTERS**

greatest O.D. 0.369 inch) and driven gear (shaft bearing greatest O.D. 0.340 inch). The drive gear shaft may be pressed out for separate replacement of shaft or gear. One bearing plug has an Alemite fitting and the other a grease pressure relief valve. The valve is set to relieve grease pressure in excess of 5 pounds per square inch and

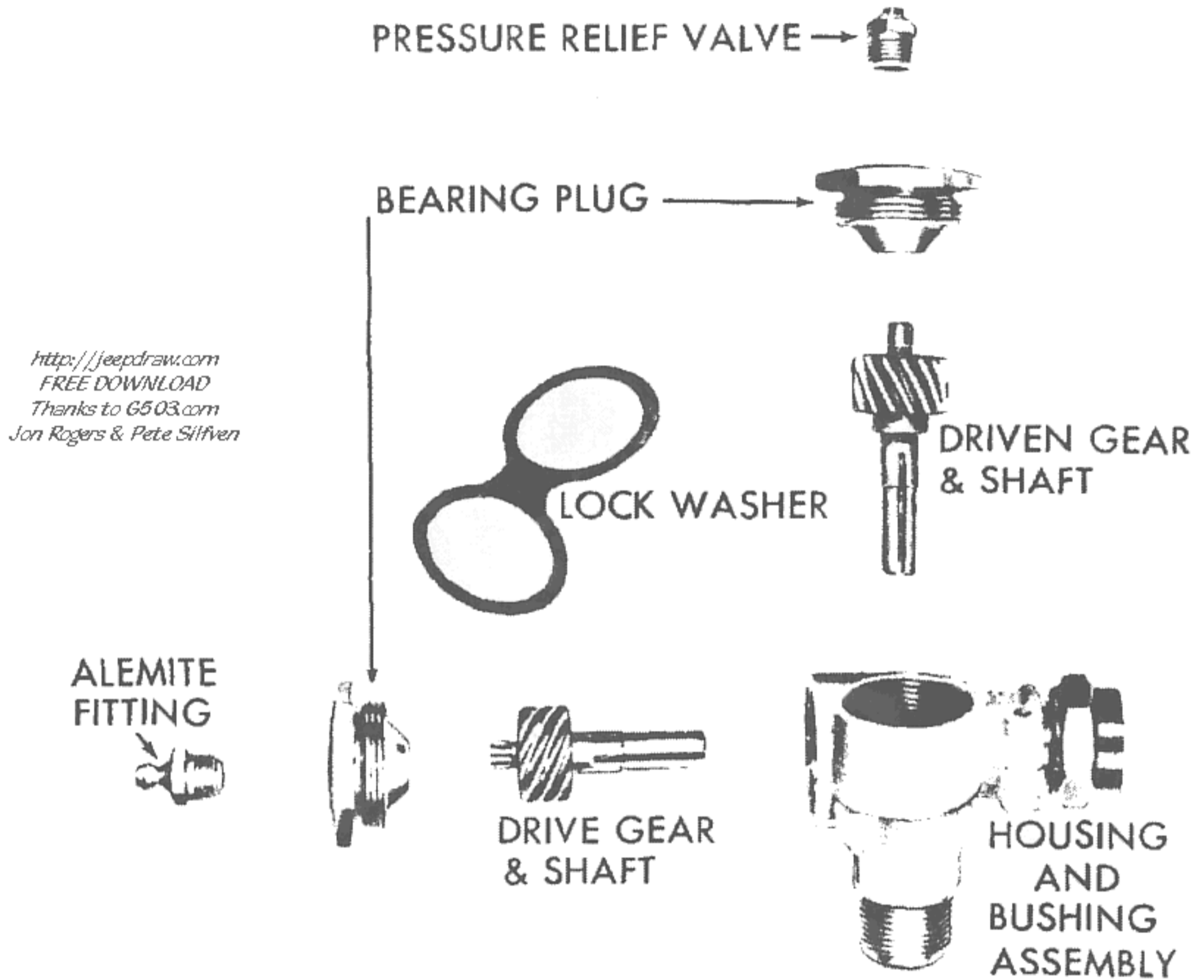

RA PD 319020

**Figure 135—AC Heavy-duty Speed Adapter, Disassembled**

must always be assembled opposite flexible shaft take-off or male threaded end. Do not disassemble the bushings at each end of the body die casting. Assembly is the reverse of disassembly. If gears are assembled on their respective shafts care must be taken to keep shaft square with gear while pressing together.

## CHAPTER 11

# STEWART-WARNER DRIVE JOINTS

### Section I

## 666-TYPE DRIVE JOINTS

### 56. DESCRIPTION.

a. The Stewart-Warner 666-type drive joint (sometimes known as an adapter) consists of a train of four gears inside a die-cast box (figs. 136 and 137). Threaded sleeves are provided for connecting the drive joint to the power take-off and for attaching the flexible shaft.

### 57. OPERATION.

a. The drive joint is attached to the transmission or other power take-off point, and merely transmits power from the take-off to the flexible shaft leading to the instrument. The 666-type drive joint is supplied in a wide range of ratios (from 0.4186 to 2.3884), and is ordinarily used to correct a speedometer or tachometer that registers fast or slow (providing instrument is correct). Such errors are caused by changing tire size, axle ratio, transmission, etc., of vehicle.

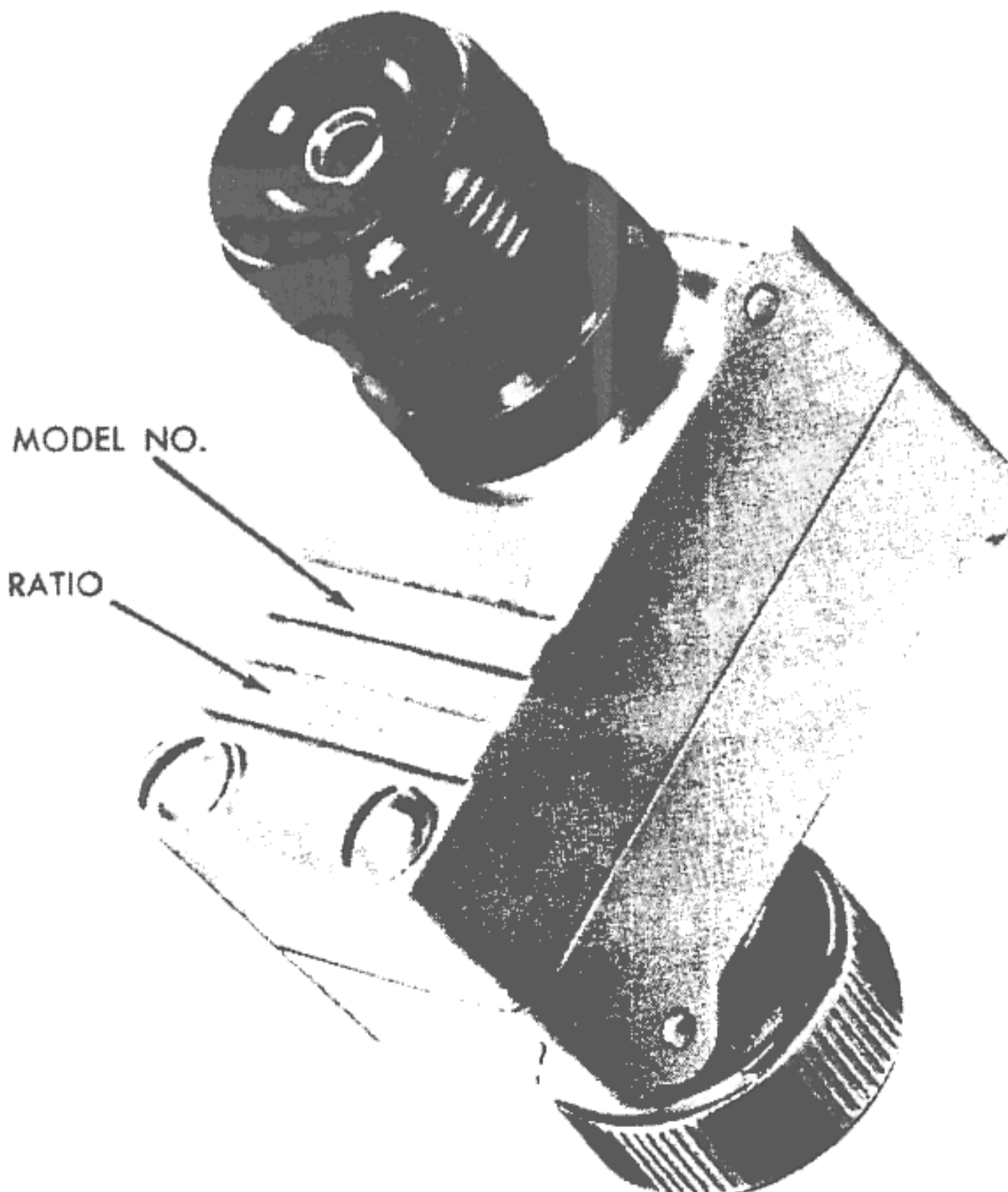

RA PD 319021

**Figure 136—Stewart-Warner Type 666 Drive Joint**

666-TYPE DRIVE JOINTS

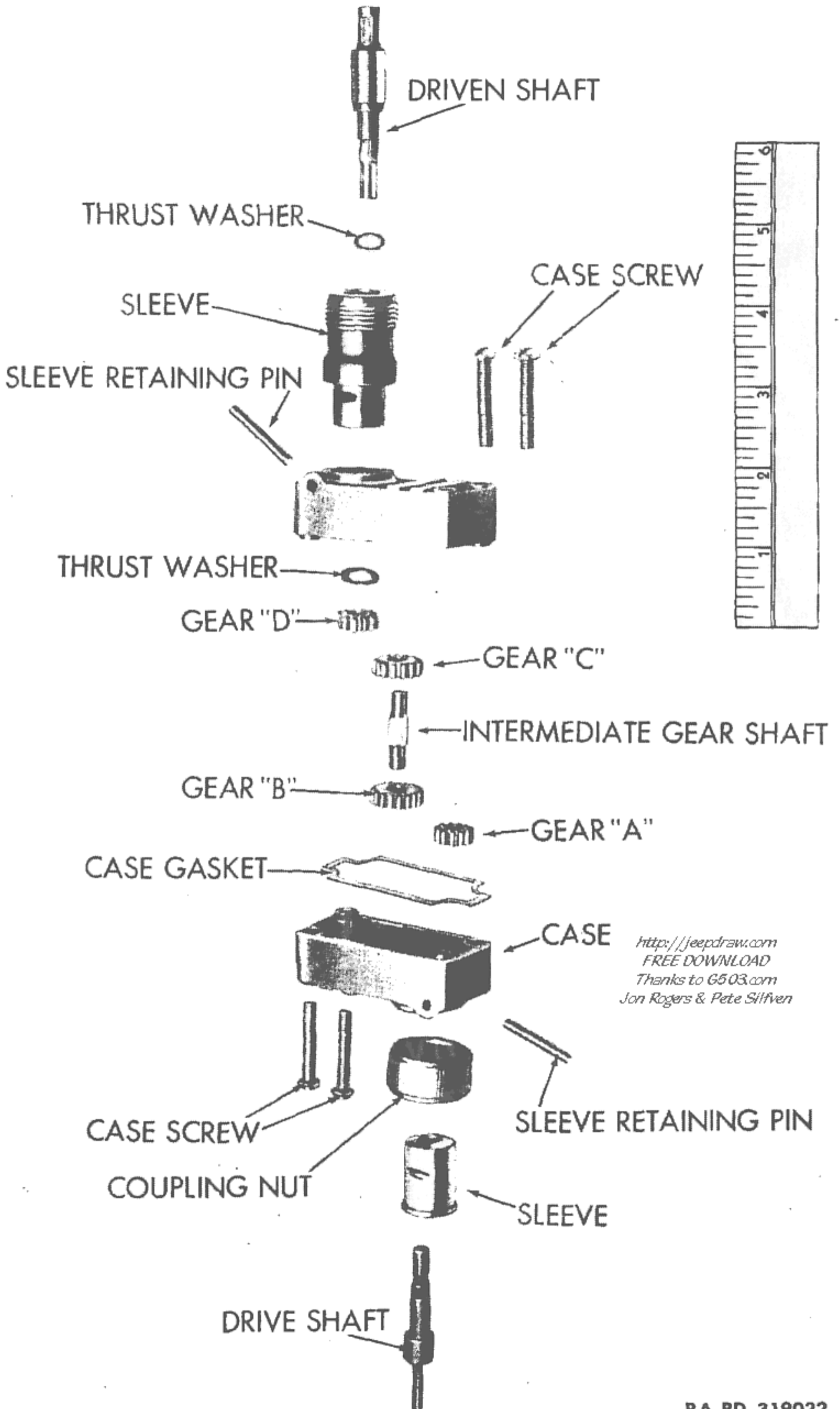

RA PD 319022

Figure 137—Stewart-Warner Type 666 Drive Joint,  
Disassembled



**ORDNANCE MAINTENANCE  
SPEEDOMETERS, TACHOMETERS, AND RECORDERS**

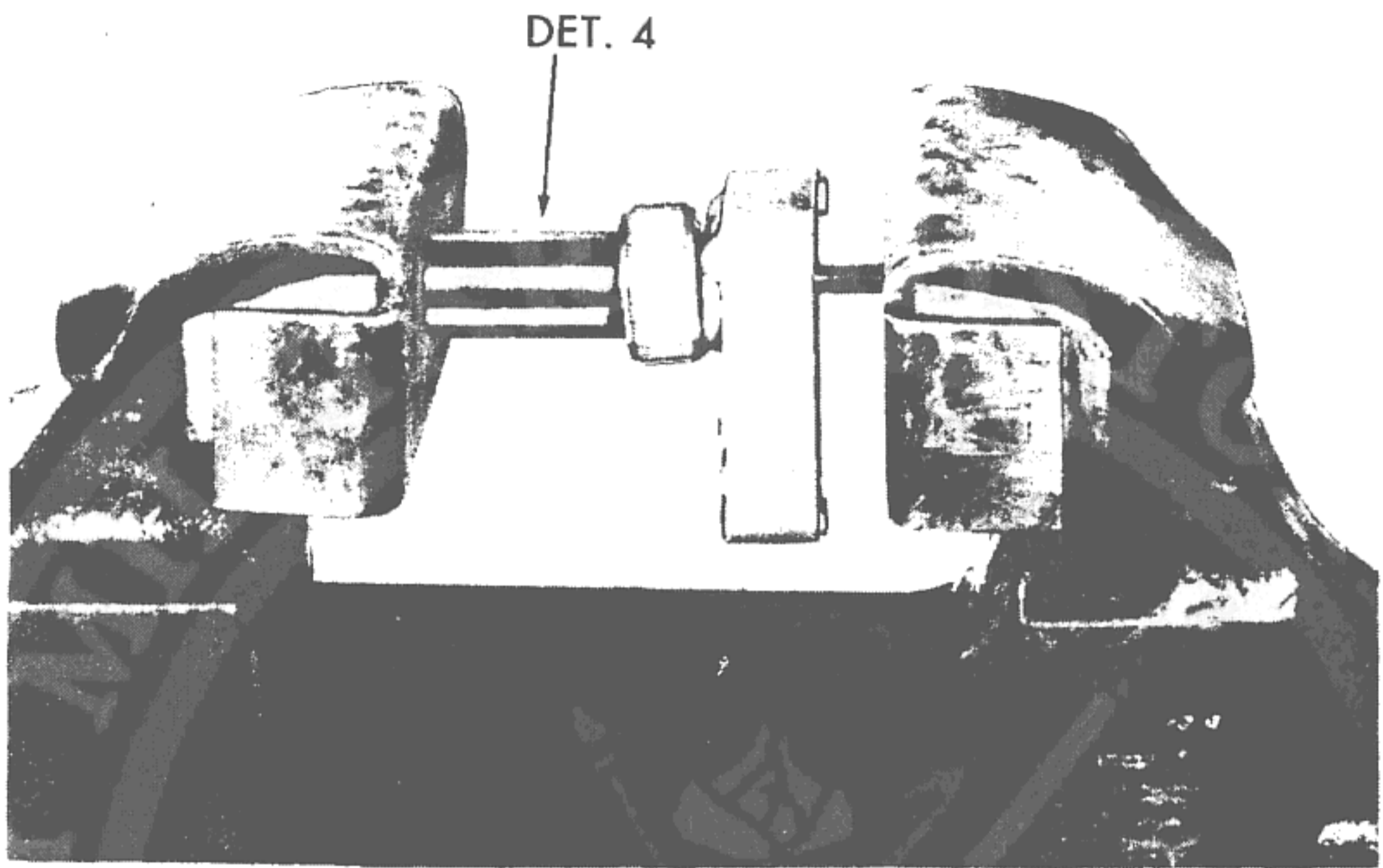

RA PD 319023

**Figure 138—Removing Gear (A), Using Adapter Tool  
(T-178708 Det 4)**

*<http://jeepdraw.com>  
FREE DOWNLOAD  
Thanks to G503.com  
Jon Rogers & Pete Silfven*

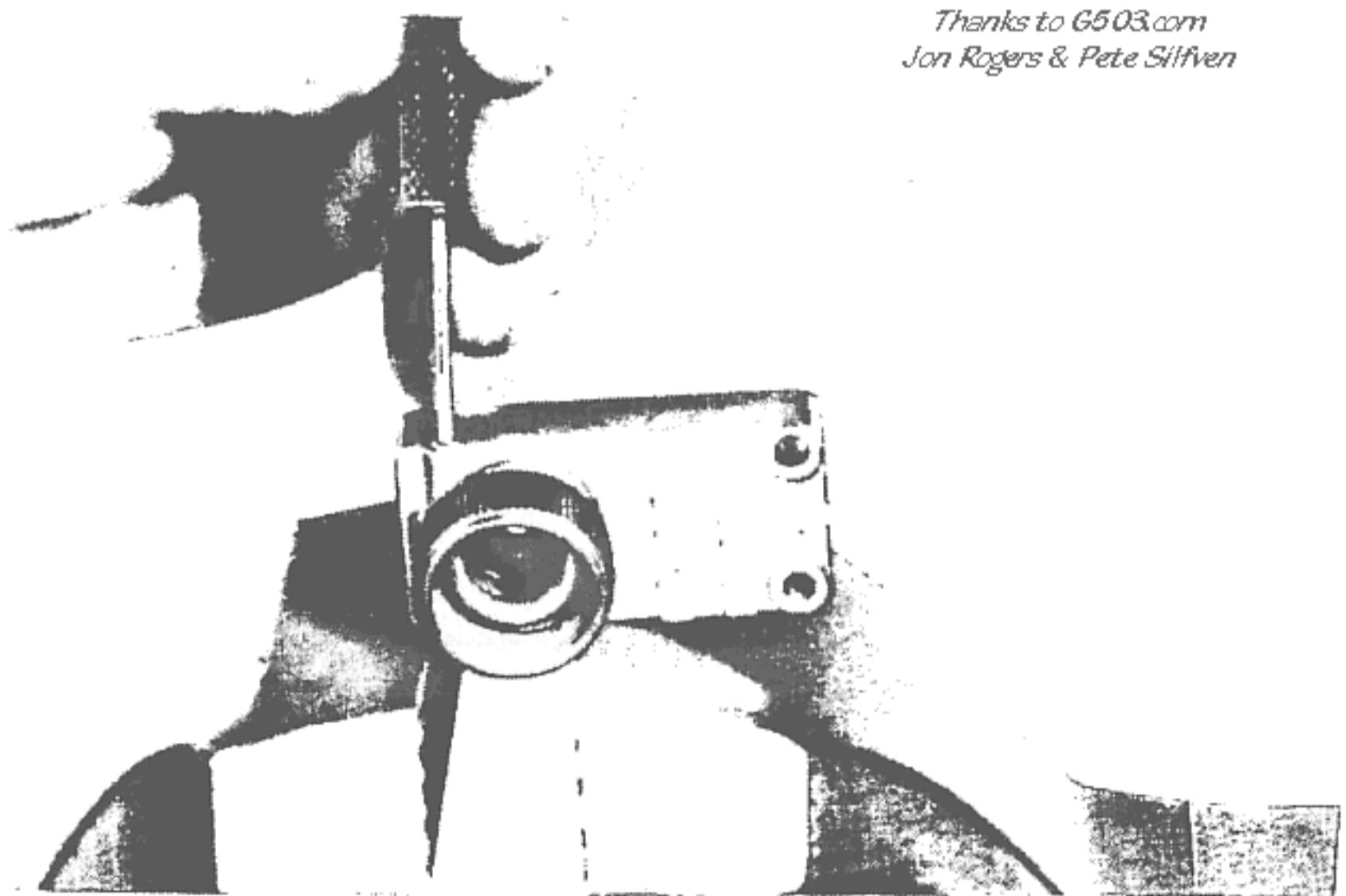

RA PD 319024

**Figure 139—Driving Out Sleeve Retaining Pin**

**666-TYPE DRIVE JOINTS**

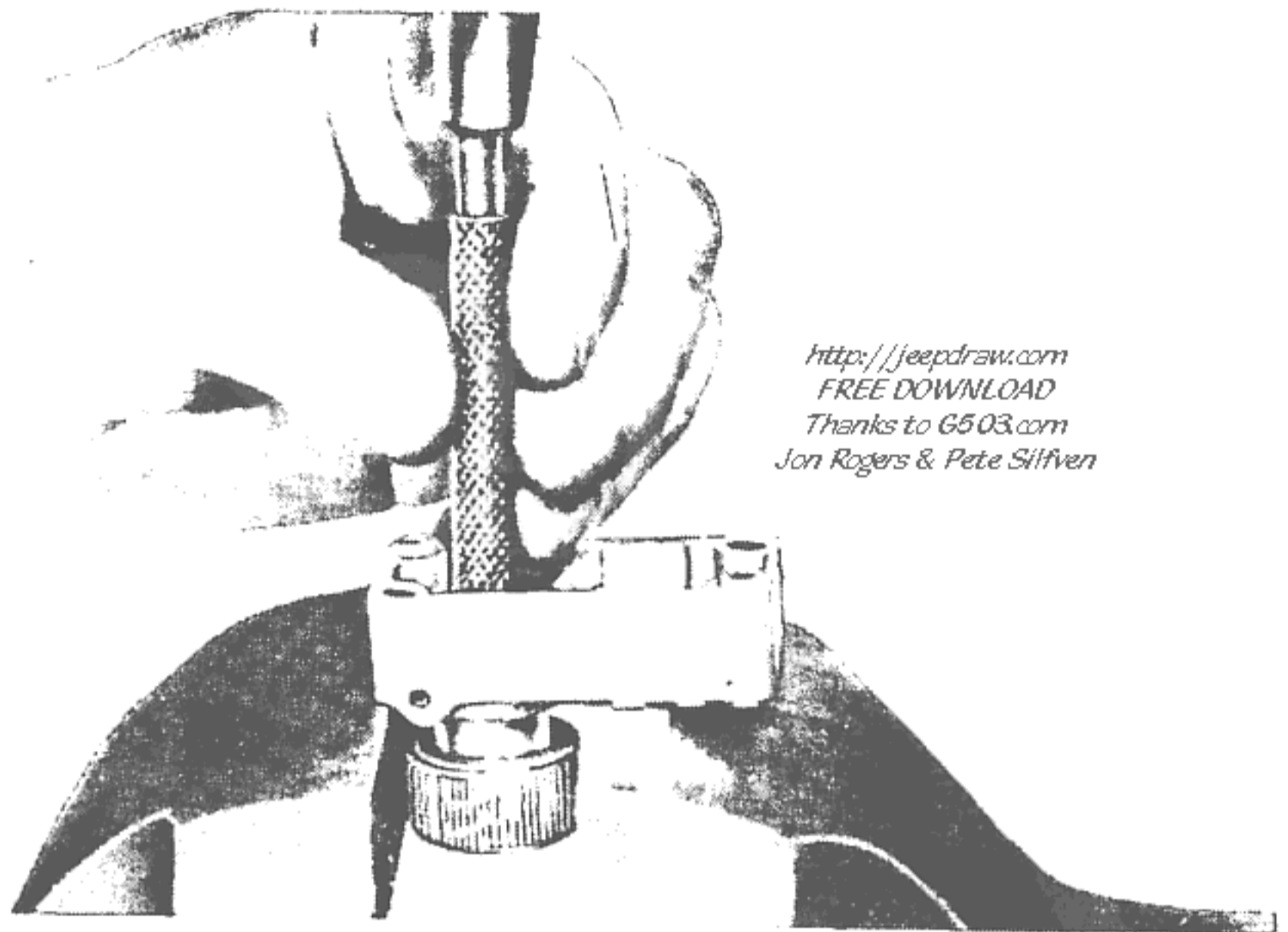

*http://jeepdraw.com  
FREE DOWNLOAD  
Thanks to G503.com  
Jon Rogers & Pete Silfven*

RA PD 319025

**Figure 140—Driving Out Sleeve**

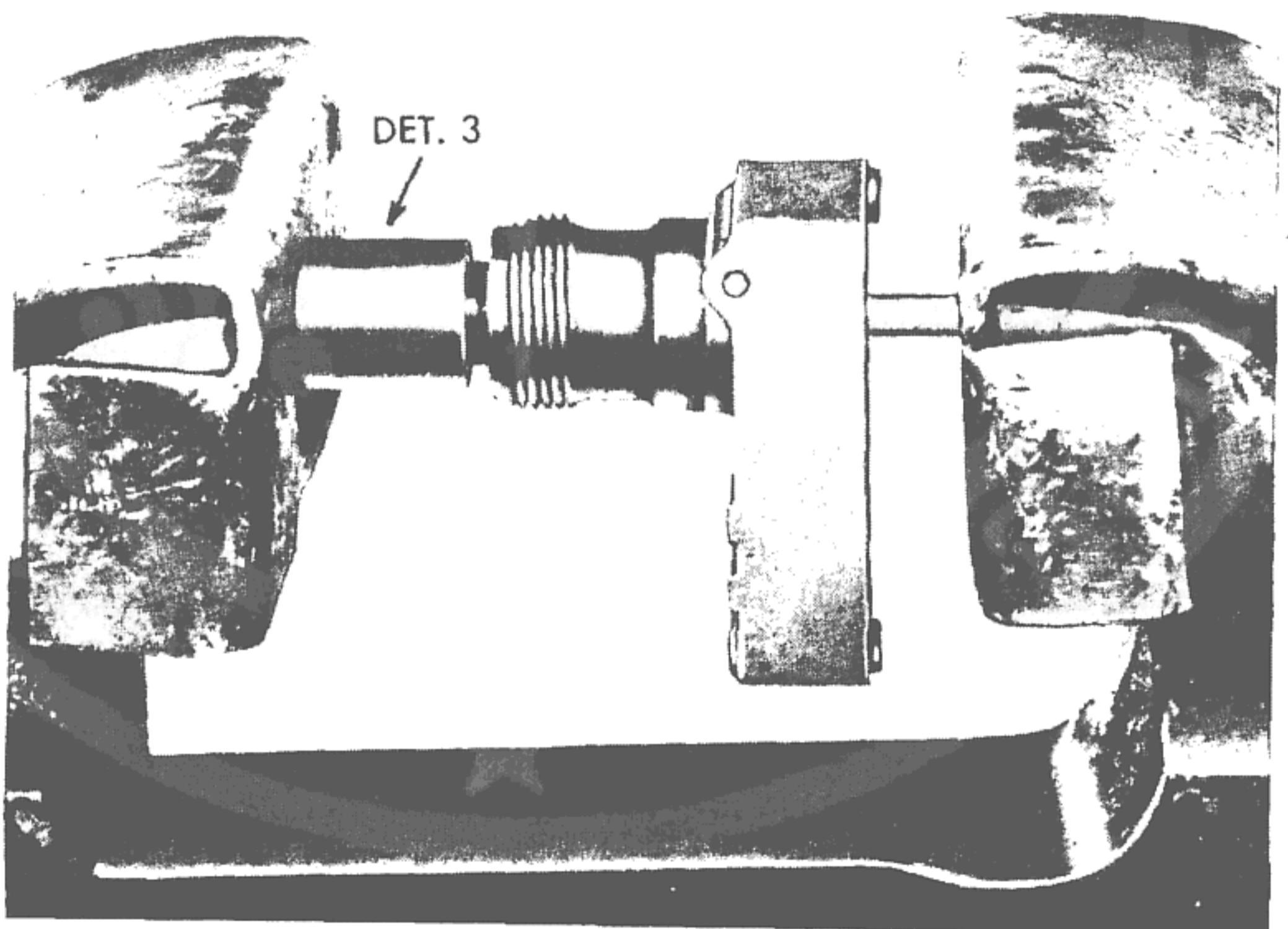

RA PD 319026

**Figure 141—Removing Gear (D), Using Adapter Tool  
(T-178708 Det 3)**

**ORDNANCE MAINTENANCE  
SPEEDOMETERS, TACHOMETERS, AND RECORDERS**

**58. DISASSEMBLY.**

a. **Remove Case.** Take out four screws holding case together, pull case apart, and lift out intermediate gear assembly (B and C, fig. 137). Mark intermediate gear assembly so that it is assembled in same position.

b. **Remove Gear (A).** Place special tool (T-178708 Det 4) and transmission end of drive joint (has female connection) in vise, and press off gear (A) (fig. 138). Brass jaws must be used on vise to prevent damage to parts. Lift out drive shaft and gear.

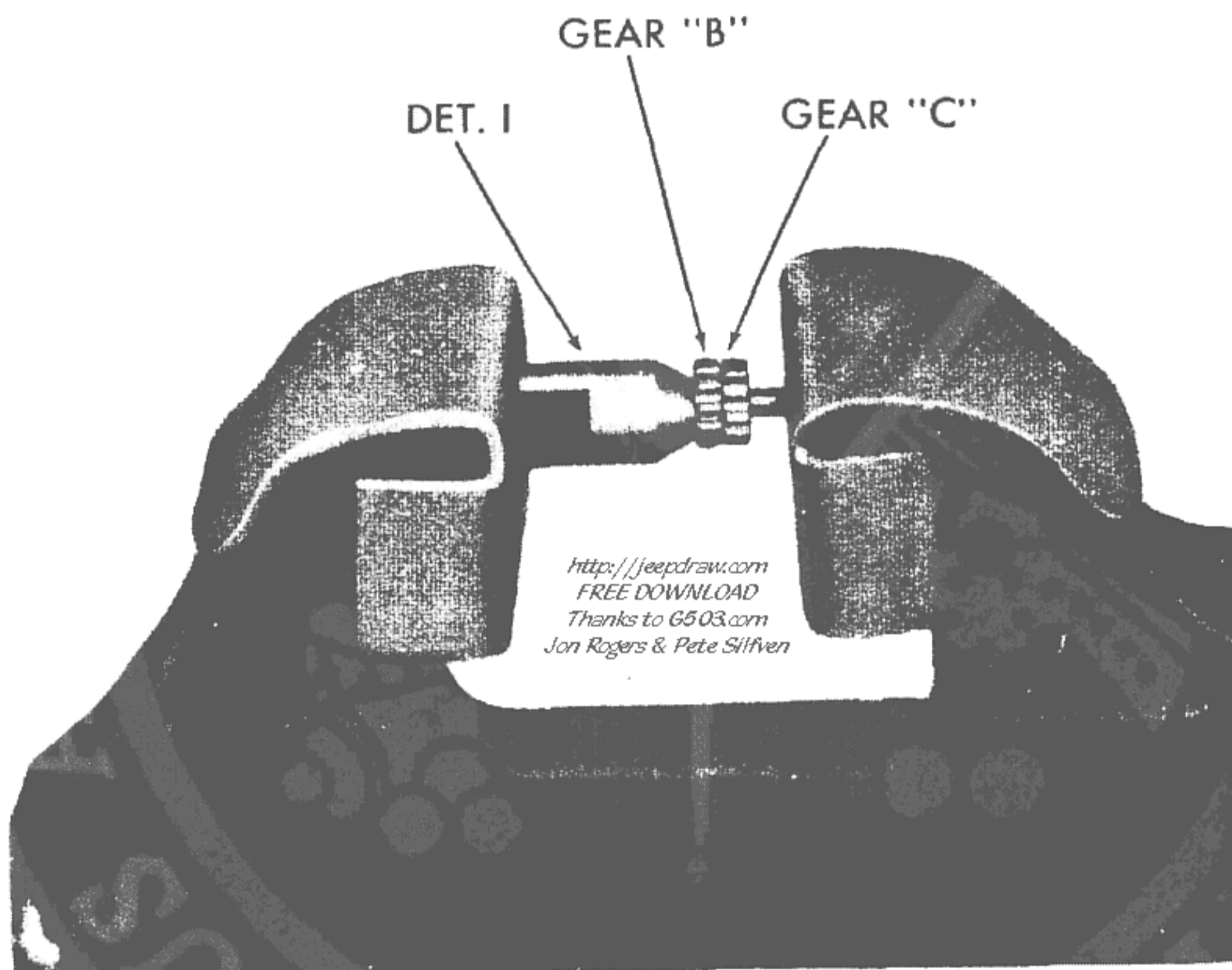

RA PD 319027

**Figure 142—Pressing Gears Off Shaft, Using Adapter Tool  
(T-178708 Det 1)**

c. **Remove Sleeve and Nut (Transmission End).** Place assembly on vise and, using punch (T-170742), drive out pin which holds sleeve in position (fig. 139). Then drive sleeve out of case (fig. 140).

d. **Remove Gear (D).** Place special tool (T-178708 Det 3) and flexible shaft end (has male connection) of drive joint in vise, and press off gear (D) (fig. 141). Lift out driven shaft, gear, and washers.

e. **Remove Sleeve (Shaft End).** Place assembly on vise and, using punch (T-170742), drive out pin which holds sleeve in position (fig. 139). Then drive sleeve out of case (fig. 140).

666-TYPE DRIVE JOINTS

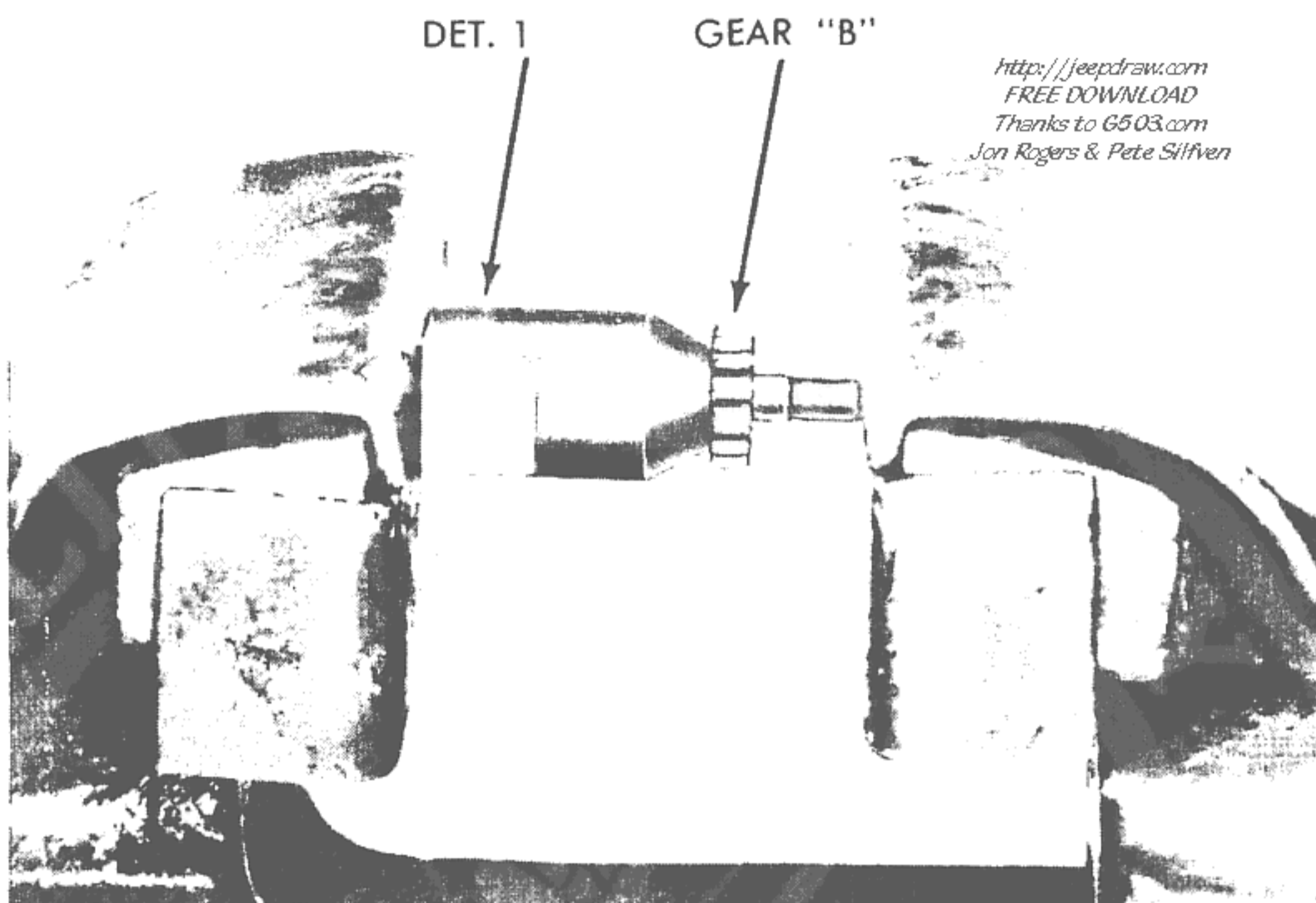

*http://jeepdraw.com  
FREE DOWNLOAD  
Thanks to G503.com  
Jon Rogers & Pete Silfven*

RA PD 319028

**Figure 143—Pressing Gear (C), on Shaft, Using Adapter Tool (T-178708 Det 1)**

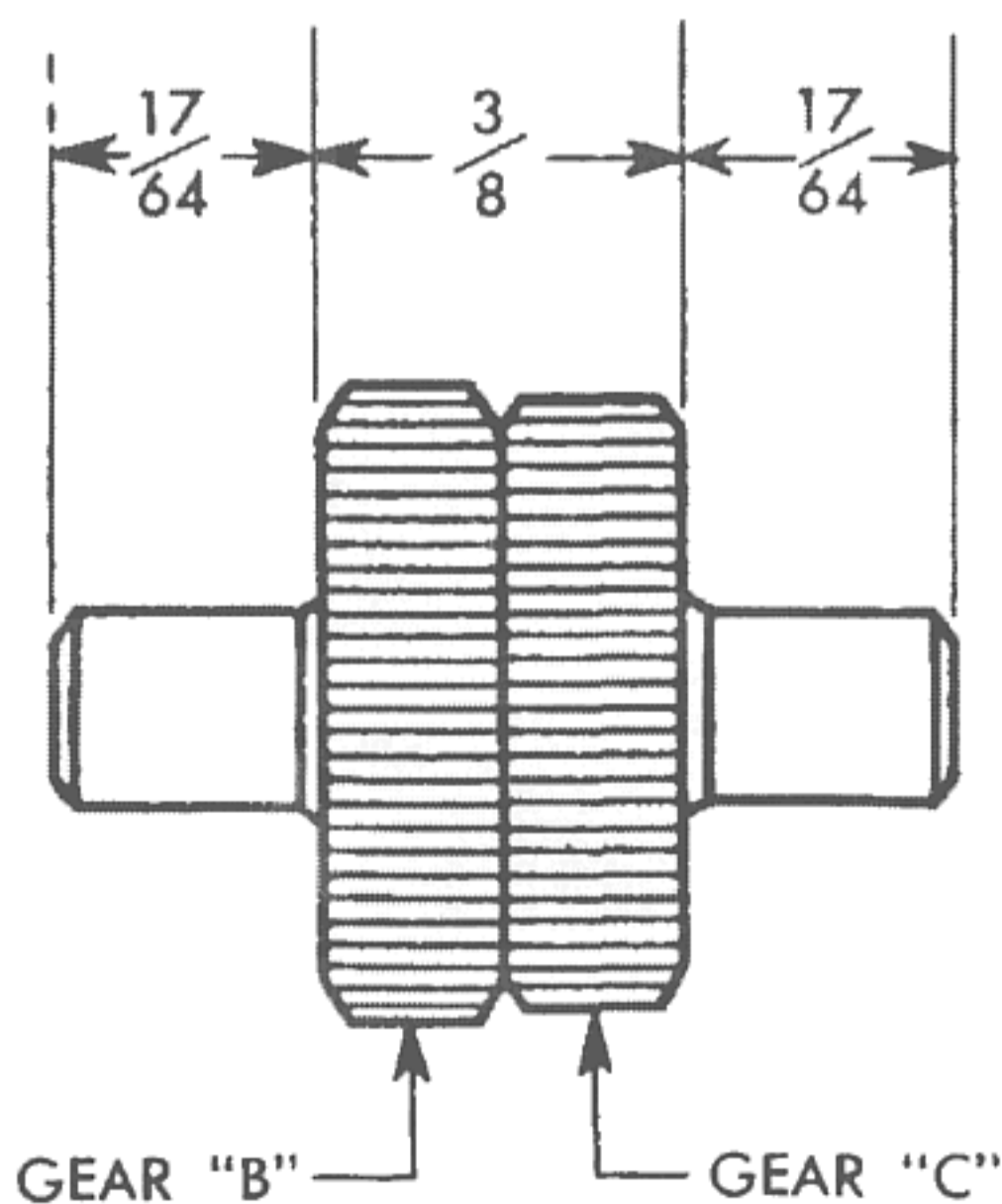

RA PD 319029

**Figure 144—Dimensional Drawing of Intermediate Gears Assembled on Shaft**

**ORDNANCE MAINTENANCE  
SPEEDOMETERS, TACHOMETERS, AND RECORDERS**

*http://jeepdraw.com  
FREE DOWNLOAD  
Thanks to G503.com  
Jon Rogers & Pete Silfven*

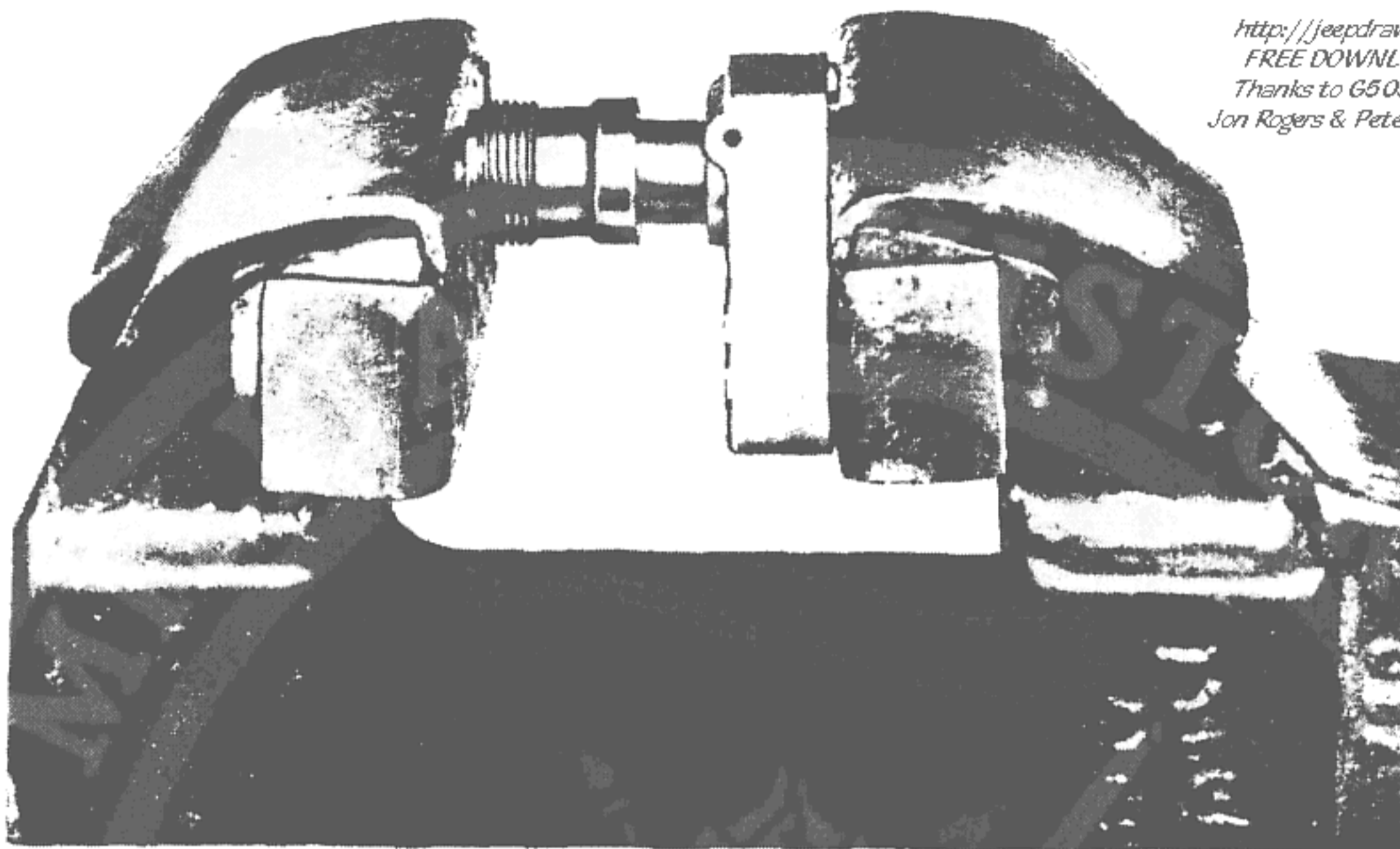

RA PD 319030

**Figure 145—Pressing Sleeve Into Case**

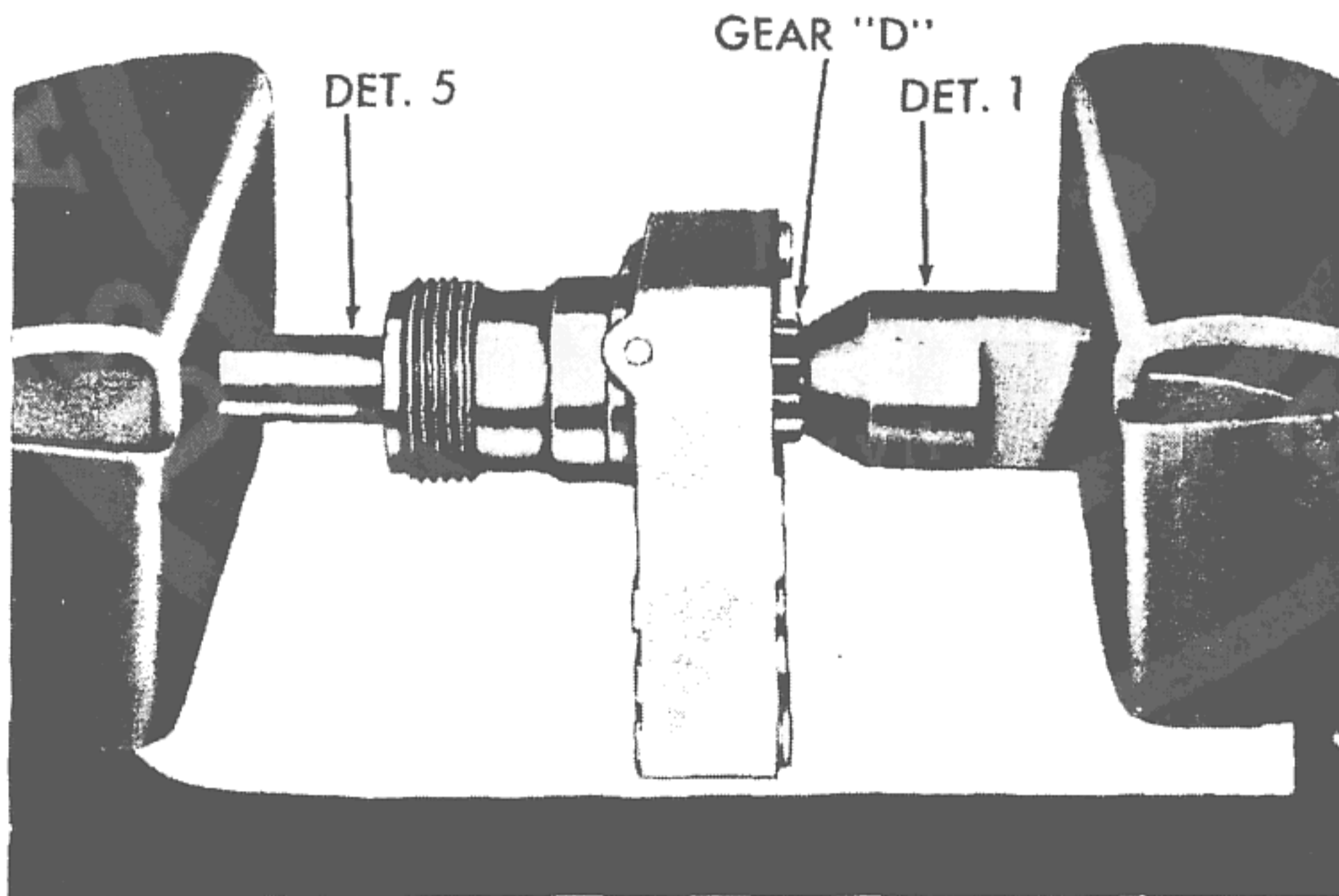

RA PD 319031

**Figure 146—Pressing Gear (D), on Shaft, Using Adapter Tool  
(T-178708 Dets 1 and 5)**

*http://jeepdraw.com*  
*FREE DOWNLOAD*  
*Thanks to G503.com*  
*Jon Rogers & Pete Silfven*

## 666-TYPE DRIVE JOINTS

f. **Remove Intermediate Gears (B and C) from Shaft.** Do not disassemble intermediate gear assembly unless gears are worn or defective. If taken apart, a new intermediate gear shaft must be used when the parts are assembled. Place special tool (T-178708 Det 1) and intermediate gear assembly in vise, and press gears off shaft (fig. 142).

### 59. CLEANING AND INSPECTION.

a. Thoroughly clean all parts with brush (T-170755) and dry-cleaning solvent. Dry parts with compressed air. Examine each one carefully and replace any that are excessively worn, broken or defec-

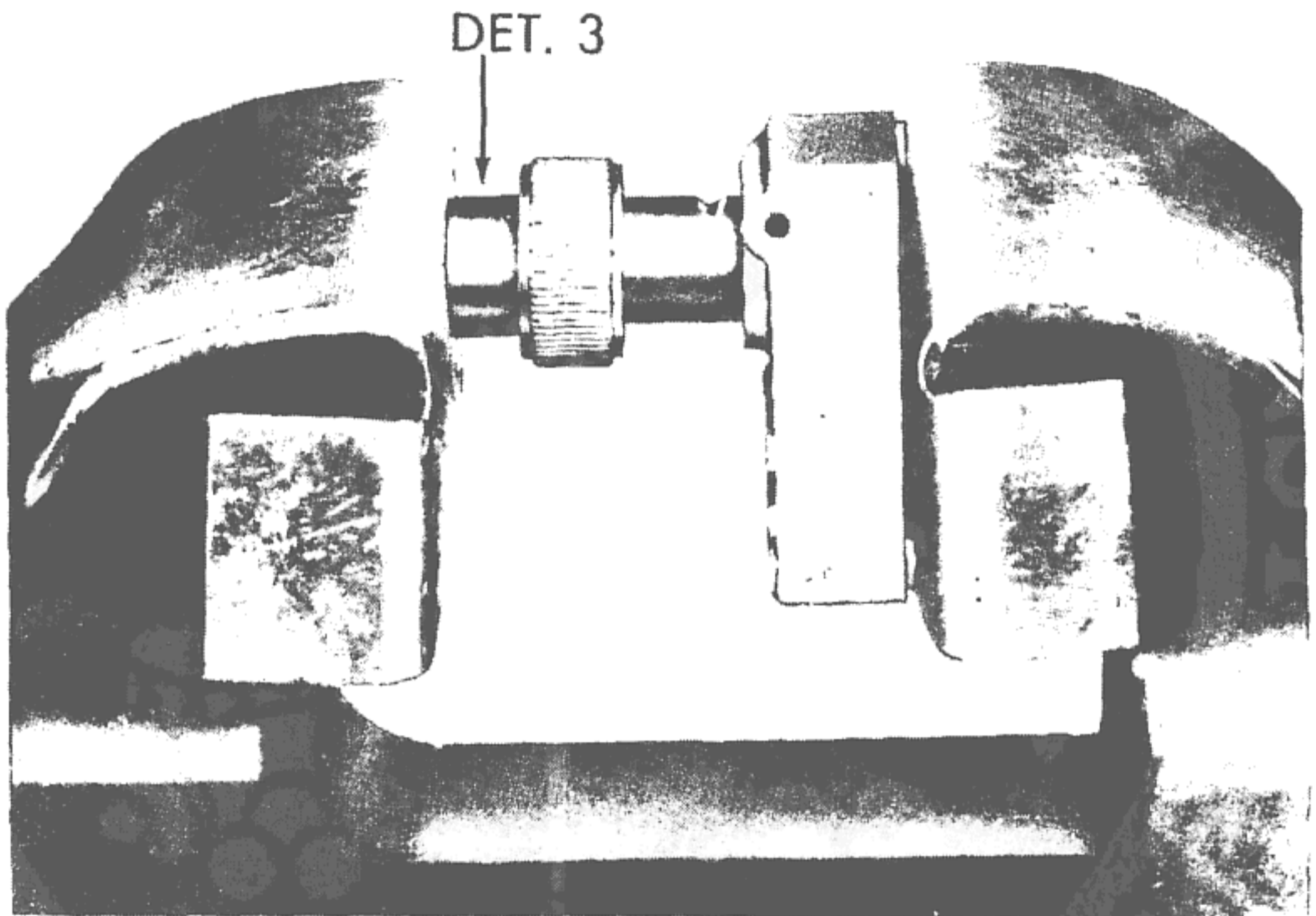

RA PD 319032

**Figure 147—Pressing Sleeve (Transmission End) Into Case, Using Adapter Tool (T-178708 Det 3)**

tive. If gears are defective and part number cannot be identified on old gear, refer to gear ratio chart in parts catalog for part numbers of proper gears for drive joint being repaired (ratio is stamped on case) (fig. 136).

### 60. ASSEMBLY.

a. **Replace Intermediate Gears (B and C) on Shaft.** Place special tool (T-178708 Det 1), new intermediate shaft, and gear (C) in vise, and press gear (C) about  $\frac{1}{4}$  inch on shaft (fig. 143). Reverse position of intermediate shaft and press gear (B) on opposite end of shaft until it is flush against gear (C) (fig. 142). The two gears should

## ORDNANCE MAINTENANCE SPEEDOMETERS, TACHOMETERS, AND RECORDERS

now be centered on the shaft so that dimensions are as shown in figure 144.

b. **Replace Sleeve (Shaft End).** Place shaft side of case and sleeve (with male thread) in vise and press in sleeve (fig. 145), making sure that slot in sleeve lines up with pin hole in case, using small hammer to drive pin in place.

c. **Replace Gear (D).** Place washer over gear end of driven shaft and place shaft in sleeve. Place another washer over shaft, and start gear (D) onto shaft. Place special tool (T-178708 Dets 1 and 5) and assembly in vise, and press gear on shaft (fig. 146) until there is about 0.001-inch end play in shaft. Remove from vise and check end play and test for free turning.

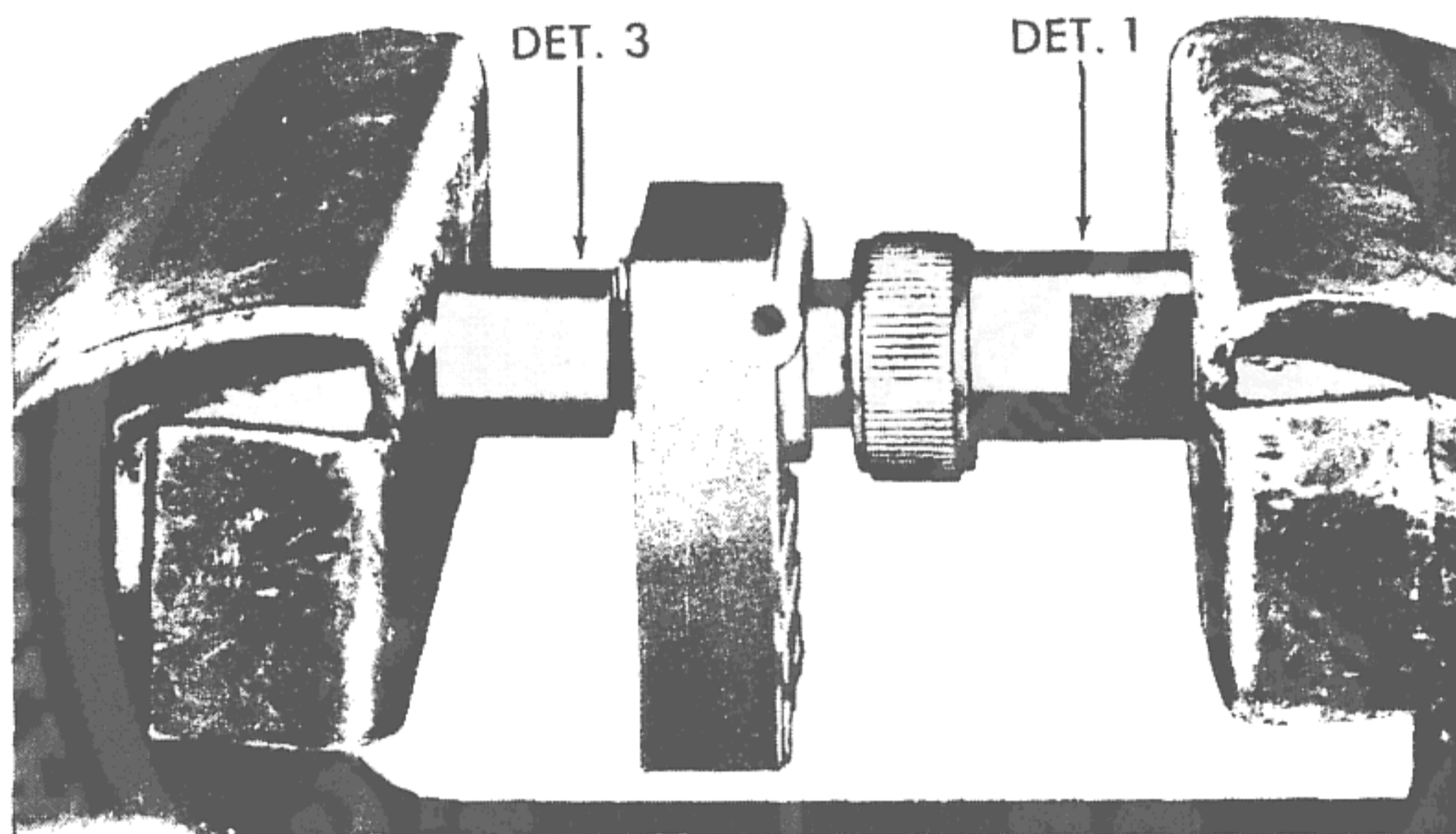

RA PD 319033

**Figure 148—Pressing Gear (A) on Shaft, Using Adapter Tool  
 (T-178708 Dets 1 and 3)**

d. **Replace Sleeve and Nut (Transmission End).** Place coupling nut over sleeve and, using vise, press sleeve into case (fig. 147) until inside end of sleeve is flush with inside of case, making sure that slot in sleeve lines up with pin hole in case. Using small hammer, drive pin in place.

e. **Replace Gear (A).** Place drive shaft in sleeve and start gear (A) onto shaft. Place this assembly and special tool (T-178708 Dets 1 and 3) in vise, and press gear (A) on shaft (fig. 148). Allow about 0.005-inch end play. Test for free turning.

f. **Assemble Case.** Place intermediate gear assembly in either half of case, making sure that it is in correct position. Replace gasket. Fill both sides of drive joint with No. 00 Grease, O.D. Make sure that the gears are in mesh, bring the two halves of the drive joint together, and replace the four screws. Test for free turning.

## CHAPTER 11

### STEWART-WARNER DRIVE JOINTS (Cont'd)

#### Section II

### 659-TYPE DRIVE JOINTS

#### 61. DESCRIPTION.

a. The Stewart-Warner 659 distributor-type drive joint (fig. 149) consists of a drive gear and shaft assembly and a driven gear mounted in a heavy casting. It is equipped with sturdy mounting brackets, and a threaded sleeve for attaching the flexible shaft. The 659 drive joint is furnished in several different models to fit various types of distributors.

#### 62. OPERATION.

a. The drive joint is mounted on the engine between the distributor head and its drive, and merely transmits power from the distributor drive to the flexible shaft leading to the instrument.

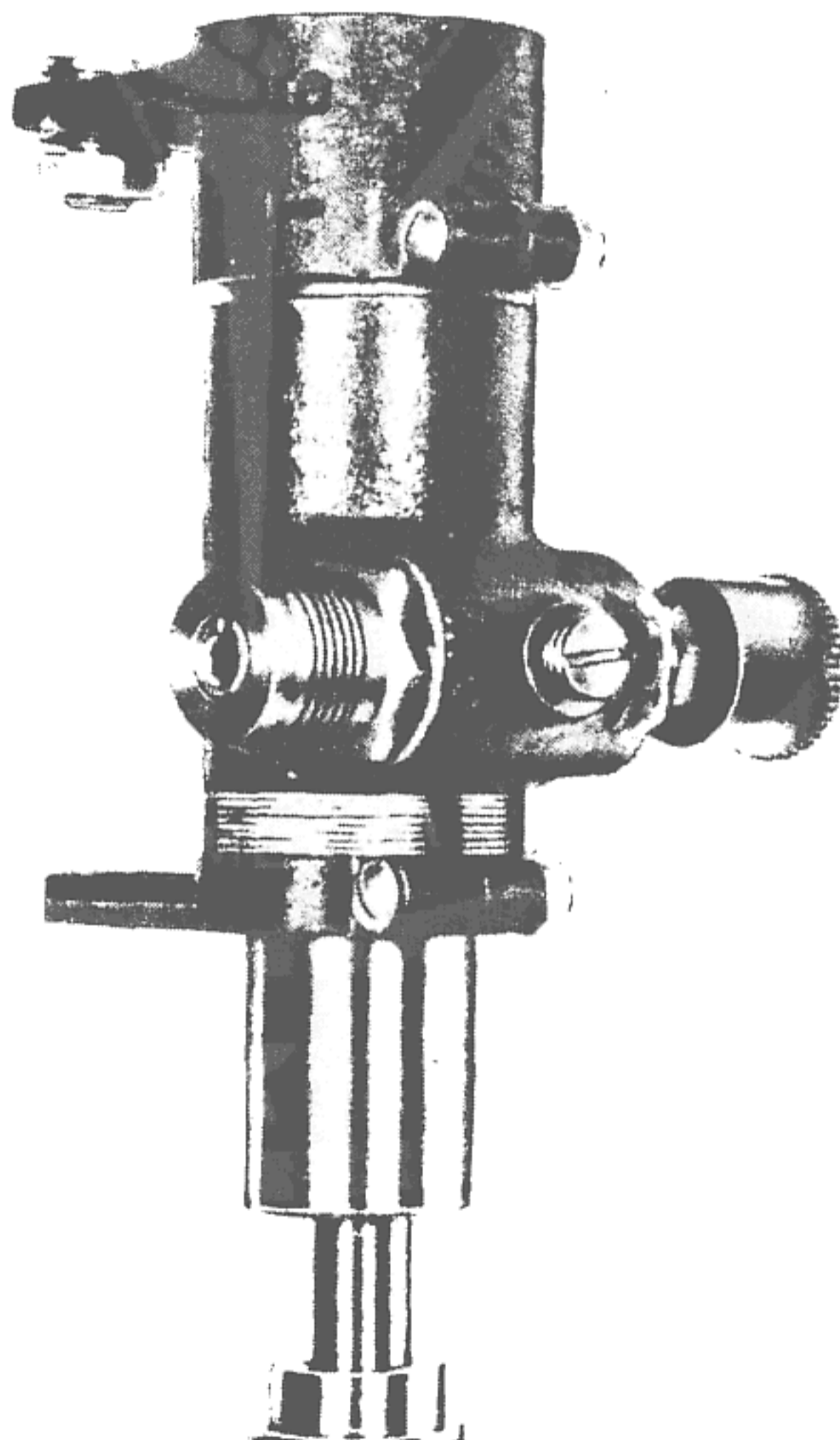

*http://jeepdraw.com*  
*FREE DOWNLOAD*  
*Thanks to G503.com*  
*Jon Rogers & Pete Silfven*

RA PD 319034

**Figure 149—Stewart-Warner 659 Distributor-type Drive Joint**



## ORDNANCE MAINTENANCE SPEEDOMETERS, TACHOMETERS, AND RECORDERS

### 63. REPAIR.

a. The only parts of this type adapter that would normally require service are the drive gear and shaft assembly and the driven gear (fig. 150). To replace the drive gear and shaft, merely slip the

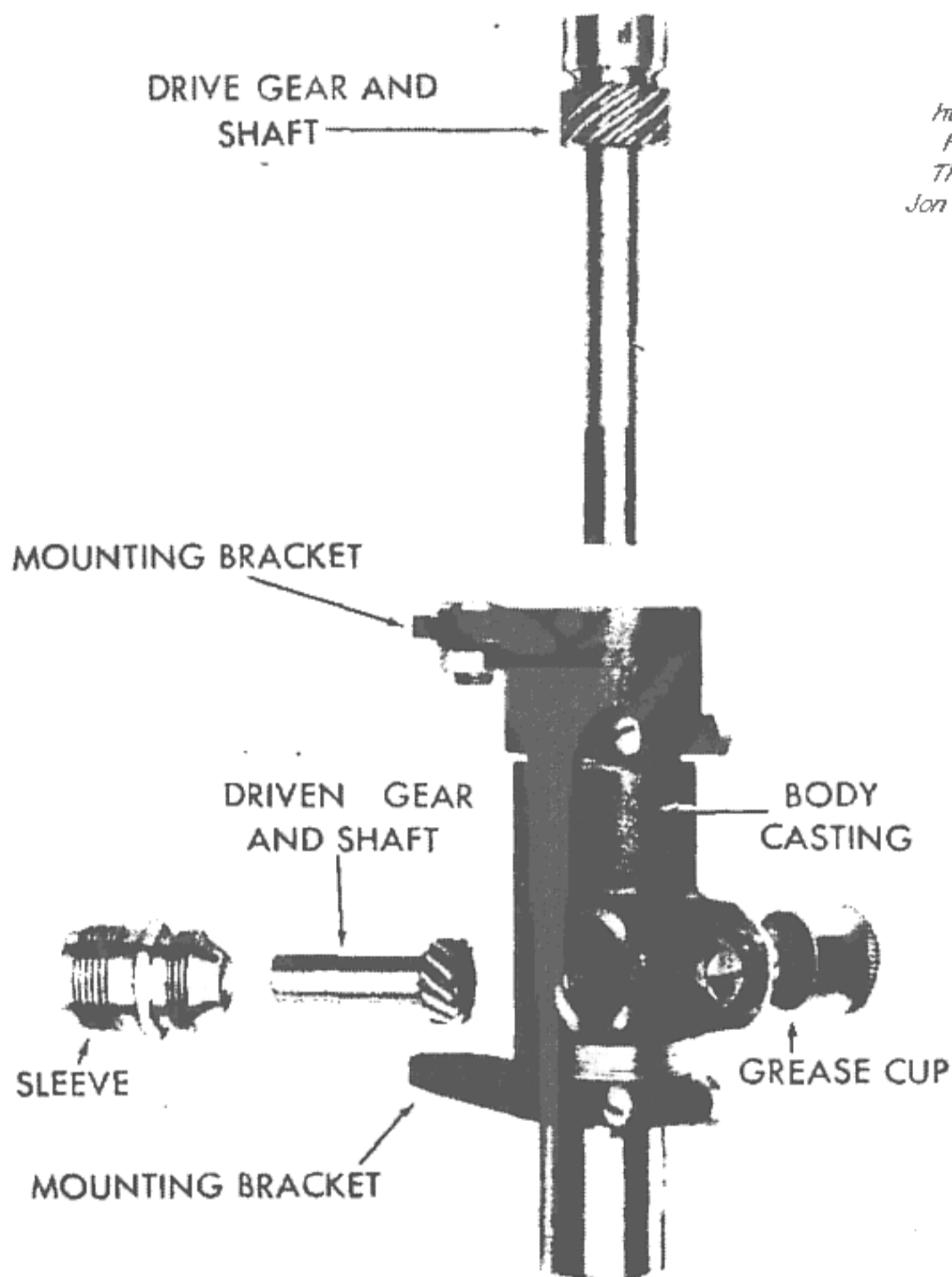

RA PD 319035

**Figure 150—Stewart-Warner 659-type Drive Joint, Partially Disassembled**

old one out of the upper end of the casting, cover the new assembly with No. 00 Grease, O.D., and slip it in place. To replace the driven gear, unscrew the sleeve from the casting, slip out the driven gear, cover the new gear with lubricant, slip it in place, and replace sleeve. Stewart-Warner drive joints and adapters, other than the 659- and 666-type, are replaced as a unit if defective.

## CHAPTER 12 SPECIAL TOOLS

*http://jeepdraw.com*  
FREE DOWNLOAD  
Thanks to G503.com  
Jon Rogers & Pete Silfven

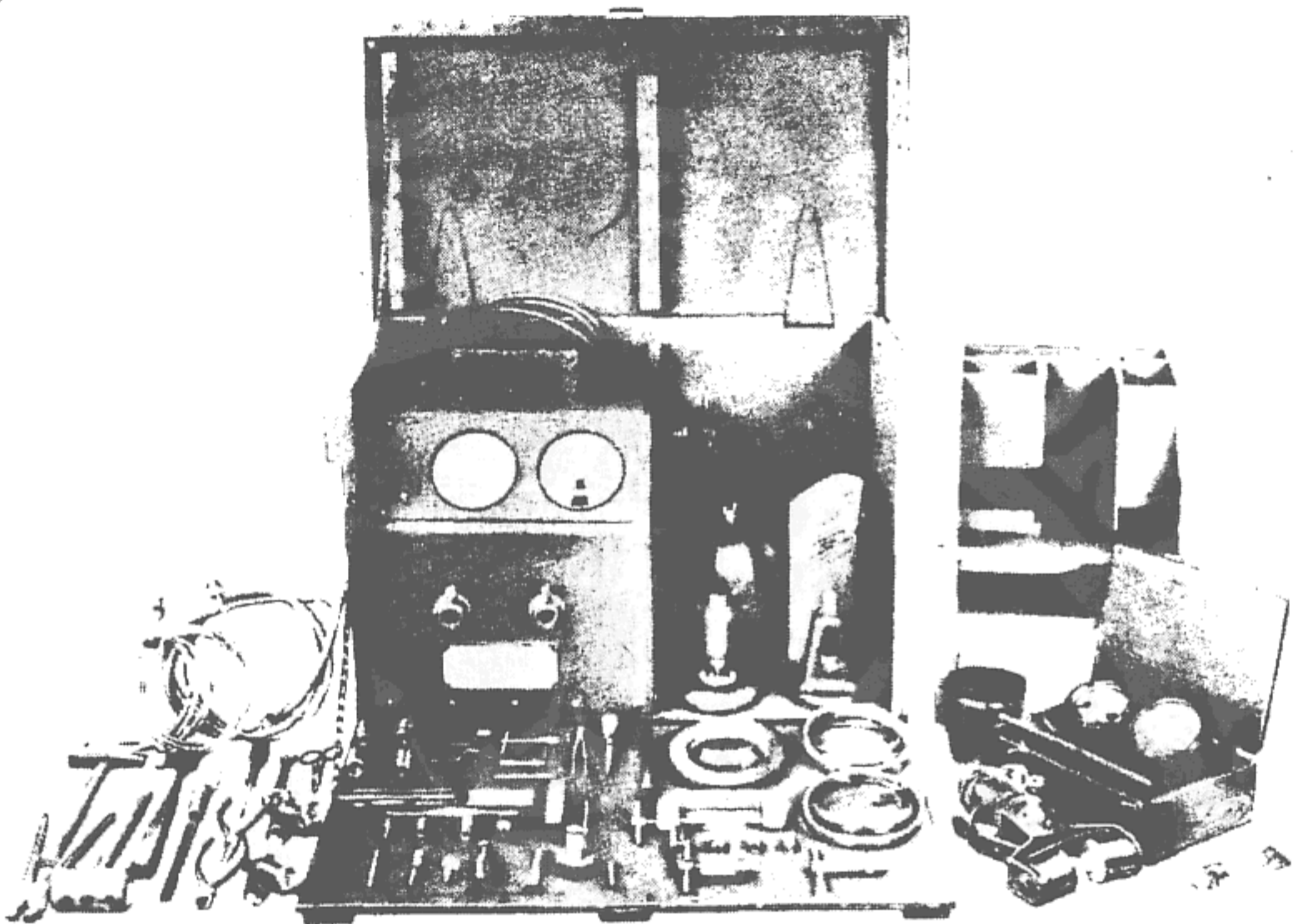

RA PD 319036

**Figure 151—Master Tool Kit (T-187852)**

### 64. SPECIAL TOOLS (figs. 152, 153, and 154).

Fig No.	Key	Tool Name	Mfr's No.
152	A	ADAPTER, calibrating (for 0.104-in. square female thread drive)	T-170886
152	B	ADAPTER, calibrating (for 0.104-in. male thread drive).....	T-170852
152	C	ADAPTER, calibrating (for 0.187-in. square drive).....	T-170863
152	D	ADAPTER, calibrating (for connecting flexible shafts).....	T-178719
153	A	ADJUSTER, calibration.....	STS-10878
153	B	ADJUSTER, front jewel.....	846862
153	C	ADJUSTER, front jewel.....	T-178705
153	D	ADJUSTER, hairspring.....	T-51742
153	E	ADJUSTER, magnet regulator...	T-178715
154	A	CRIMPER, flexible shaft ferrule..	T-52644
153	F	EXTRACTOR, gear.....	ST-263-34
154.	B	FIXTURE, bezel rolling.....	T-178730

## ORDNANCE MAINTENANCE SPEEDOMETERS, TACHOMETERS, AND RECORDERS

Fig No.	Key	Tool Name	Mfr's No.
154	C	FIXTURE, inner core cutting, squaring and tip attaching....	T-136374
153	G	FIXTURE, magnet assembly.....	T-170666
153	H	FIXTURE, staking, intermediate gear .....	T-178717
153	I	GAGE, feeler (0.005-in.).....	ST-263-27
153	J	GAGE, feeler (0.003-in.).....	ST-263-31
—	—	GREASE, hi-low test.....	408083
—	—	GREASE, magnet bearing.....	ST-263-36
153	K	INSTALLER, gear .....	ST-263-35
152	E	JOINT, swivel (for CW drive)...	T-176827
152	F	JOINT, swivel (for CCW drive)..	T-178704
154	D	KIT, disassembly and assembly Stewart-Warner type-666 drive joints .....	T-178708
153	L	KIT, hair spring assembly.....	T-29
152	G	KIT, magnet strength tester and hair spring .....	408082
151	—	KIT, master tool.....	T-187852
152	H	MACHINE, calibrating (complete with accessories).....	T-170645
153	M	MAGNETIZER and DEMAGNETIZER	846294
154	E	PLIERS, crimping, flexible shaft ferrule .....	T-122308
153	N	PULLER, disk-type pointer.....	T-131105
153	O	PULLER, hair spring.....	T-66296
153	P	REMOVER, pressed-on bezel.....	T-42358
152	I	SHAFT, flexible extension (for 0.104-in. female drive).....	95000—72 in.
152	J	SHAFT, flexible extension (for 0.104-in. square male drive)..	97800—72 in.
152	K	SHAFT, flexible extension (for 0.187-in. square male drive)..	36800—72 in.
152	L	TESTER, magnet strength.....	408164
152	M	TESTER, magnet strength.....	408165
153	Q	WRENCH, magnet dismantling..	T-170654
153	R	WRENCH, spanner, elbow joint gear .....	T-49509
153	S	WRENCH, spanner, odometer dial alining .....	T-40783