

81.14.439

ARMY MOTORS

Volume - 3 January 1943 Number - 10

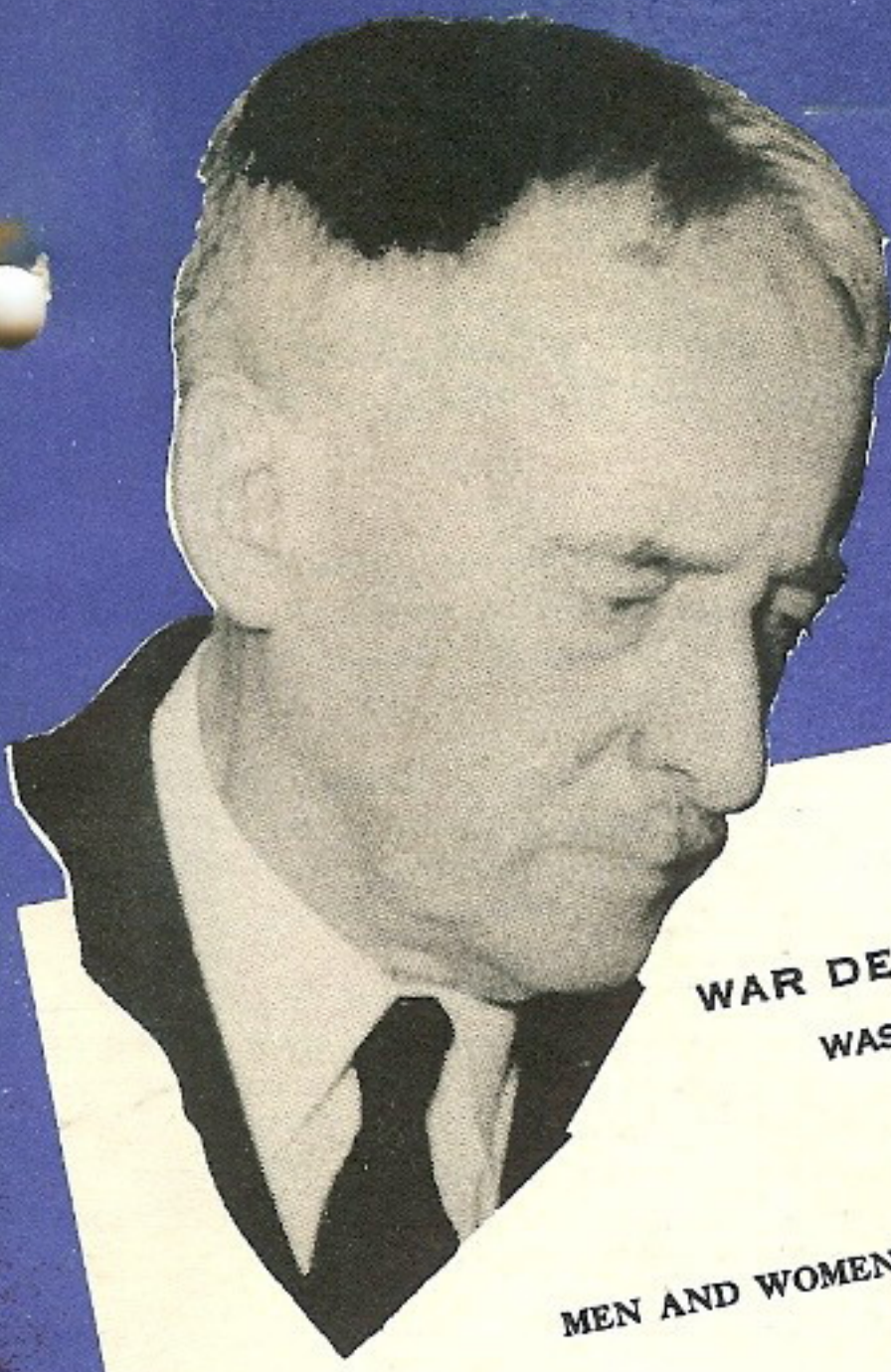

WAR DEPARTMENT
WASHINGTON

MEN AND WOMEN OF THE ARMY OF THE UNITED STATES:

Maintenance of trucks, tanks and all the vehicles of war at a high standard of performance is as important to the success of the Army as the physical fitness of its personnel.

"I call on each man and woman serving with the Army of the United States to unite in a campaign of PREVENTIVE MAINTENANCE...to abolish the menace of mechanical failures.....This is your responsibility..."

~~Industry has provided~~
This is your responsibility. I depend upon you to see it through.

Henry L. Stimson
Secretary of War

Complete text of Secretary Stimson's message on inside back page

BATTLES ARE WON BY VEHICLES THAT RUN



Steering Wheel

The Spirit Of Spit And Polish

It was W. Somerset Maugham who told the story of the Englishman alone in the dark and steaming jungle who dressed every night for dinner. In the savage outlands, it was his way of rising above his environment and retaining the civilized habits of respectability, character and 'form'.

Something of the same situation confronts the military driver today. In 1939, the U.S. Army dropped the tradition of spit and polish, and vehicles were painted a dull olive drab. Gone was the high gloss and brightwork as the Army crouched lower to the protective color of earth.

Unfortunately in some cases, this move has had the effect of relaxing discipline, and vehicles appear liberally stained with grease spots, rust spots and mud. The floor of the cab carries a small cargo of candy wrappers, dry leaves and old comic-book pages.

"So what?" asks the hard-bitten soldier thinking of the knuckle-busting, back-breaking, never-ending chores of lubricating, tightening and adjusting. "Why harp on the @*!!*☆@!! piddling matter of keeping them clean when we got our hands full keeping them going?"

Well, a long time ago, a wise guy found out that the easiest way to split a rail was to get a wedge in. In the same way, a small crack in the rigid discipline surrounding trucks, may lead to a collapse of the whole structure of maintenance.

It's human nature and a matter of morale. Neglect a little rust spot on the fender and pretty soon you'll put off lubricating that hard-to-get-at fitting underneath the truck. It's so easy to slip. One drink, two drinks and first thing you know you're the village rumpot. Skip this fitting, forget to push the choke button in, and before you know it, your truck is the company junk wagon.

Maintaining discipline, retaining 'form', is a little personal affair of the driver's. Oh sure,

there's the evil eye of the motor sergeant focused upon you, and the inspections to make you jump, but day by day maintenance and that little extra something, depends on you alone.

We'd like to conclude today's sermon by quoting from an especially fine memorandum written by Travis H. Cramb, 1st Lt., Cavalry, Motor Office of the 30th Cavalry, Reconnaissance Troop, Camp Blanding, Florida:

Keep in mind that we are a Mechanized Organization, and our vehicles are our weapons. The difference in taking 5 or 10 extra minutes to make sure your vehicle will keep rolling, or letting it go for the maintenance section to repair for 5 or 10 hours may not only cost your life, but may mean the annihilation of a whole regiment or division.

Any driver who wilfully or carelessly neglects his vehicle is as guilty of sabotage as though he had actually tried to destroy the vehicle.

The bright brass buttons are gone, but the spirit of spit and polish lives on.

In This Issue . . .

JANUARY 1943

Dead Storage	285
Gear Case Lube Level	286
Connie Rodd	288
Rumors	291
GMC Ventilating System	292
Combat Wheel	299
Praying Trailer	300
60-ton Press Plate	301
Gen'l Officer's Flagstaff	303
How Tight is Tight?	305
Dangerous Air	306
Contributions	307
Half-Mast	310
Secretary Stimson's Message	Inside Back Cover



ARMY MOTORS is published monthly in the interest of Preventive Maintenance by the Maintenance Engineering Unit*, Holabird Ordnance Base, Baltimore, Maryland. Your contributions of ideas, articles and illustrations are welcome. Address all correspondence to the Editor, at the above address.

* A Unit of the Preventive Maintenance Section, Maintenance Branch, Field Service Division, Office of the Chief of Ordnance.

Hot Words

The article on page 286, "The Level of Lube in Gear Cases," being somewhat controversial, we thought maybe before printing it, we'd better pass the page proofs around for comment. No sooner thought than done, and no sooner done than the entire eastern seaboard stretching back to the wilderness that is Detroit, was locked in a bitter Civil war. From the ivory towers of Detroit's Fisher, and Union Guardian buildings, snipers snapped angry opinions past our ears, and a fierce flanking movement swept up from the lower floors of Holabird's Engineering Division.

Washington rushed to our rescue with a few well-placed directives; and if it hadn't been for a little intramural strife in which our copy boy made our chief editor eat a few four-letter words, we might have come out all right.

At any rate, as the matter stands now, the article is adjudged to be sound and solid in all particulars. However, we'd like to say an additional italicized word: *The manufacturer's maintenance manuals in specifying that the lubricant level in gear cases is to be right at plug level, are absolutely right.*

And our own recommendation, based on military experience, that lube be installed to a level 1/2-inch-below-the-plug is also right. (Lube installed in cold gear cases, may pile up at the back of the case, on top of the gears, etc., resulting in too high a level when operation finally warms the lube up.)

The best thing for you to do then, is use your own discretion and 'know-how'. Maintain the lube level in the range between plug level, and 1/2-inch-below-the-plug-level. Neither above nor below this range. And in checking the level of lube after operation, give the foaming a chance to subside.

And wait for our follow-up story next month which will be complete with snappy illustrations, gags, girls and tiresome details. In addition to which a free set of dishes will be given away.

* * * * *

Here's a last-minute flash on the 'Praying Trailer' story on page 300: Word has just been received that the alteration in the backing braces of the Dayton landing gear is now being incorporated on all of these assemblies now in production.

Follow the procedure outlined by the Holabird Engineering Division in our story, and have the alteration made on those of your trailers that have the Dayton landing gear.

Wint
You run
on short
The bitt
engines
the swea
pipes r
rooms,
water sp
inner su
then run
the oil

It le
gremlins
densator
engine ho
it off; s
In no tim
water mi
form a har
deserves
the unpro

So i
weather a
are used
hardly a
dead sto

But l
rot vehic
rosion at
batteries
grow old
gasoline
and carbu
gummy -

For t
group of

DEAD STORAGE



The sludge season is on. If you run vehicles only a little or not at all, put them in sweet hibernation.

Wintertime is sludgetime. You run many of your vehicles on short errands and park them. The bitter cold cools the hot engines quickly and, just like the sweat that grows on cold pipes running through hot rooms, the little drops of water spring up all over the inner surfaces of the engine, then run down and mingle with the oil in the crankcase.

It looks like the work of gremlins, but it's only condensation. Long runs make the engine hot enough to evaporate it off; short runs pile it up. In no time at all the condensed water mixes with the oil to form a harmful mess that richly deserves - and resembles - the unpretty name of *sludge*.

So if you're in a cold-weather area and your vehicles are used for short runs or hardly at all, put them in dead storage.

But long periods in storage rot vehicles. Rust and corrosion attack metal surfaces; batteries drain and die; tires grow old before their time; gasoline in the tank, lines, and carburetor gets stale and gummy - slow death sets in.

For this reason, a small group of bald men stayed up

late nights, not long ago, to figure out ways and means of preventing stored vehicles from falling into decay. They emerged from their labors with considerably more flesh around the base of their spines and a complete check list which has been set down in AR 850-18 as a standard for men to live by.

Use it to prepare those of your vehicles which won't be required for an indefinite period, for a good winter's sleep. Here's the gist of

the check list.

ENGINES

Crankcase: Drain the oil out of the engine while it's still warm - remove drain plugs from the crankcase and strainer chambers. Take off, clean and reinstall all removable oil screens and fuel strainers - including blade-type oil strainers.

Screw the drain plugs back in the engine. Requisition 'Oil, lubricating, preservative, medium,' (see box this page) and fill the crankcase half-full of it. Start up the engine and run it for 15 minutes at about 1000 rpm.

Leave the preservative oil in the crankcase.

Cylinders: The cylinder walls, piston heads and valves must be coated with the preservative oil. AR 850-18 reveals that 'Special Spraying outfits, Army Air Forces Specification, No. 50127 are available for applying...' the preservative oil. We can't say offhand who's entitled to get this special spraying outfit; but if you can get it - or a reasonably

(Continued on page 313)

Two preservative materials are mentioned in this article. One is a preservative oil, the other is a rust-preventive compound. Both may be requisitioned by the following names from the Ordnance Depots listed below:

- 1) "Oil, lubricating, preservative, medium, Ordnance Dep't Specification AXS-674."
- 2) "Rust-preventive compound, light, U.S. Army Specification 2-84."

Augusta Ordnance Depot, Augusta, Georgia

Benicia Ordnance Depot, Benicia, California

Raritan Ordnance Depot, Metuchen, New Jersey

Rock Island Ordnance Depot, Rock Island, Illinois

San Antonio Ordnance Depot, San Antonio, Texas

- 3) The "flushing oil" referred to is SAE 10.

The Level of LUBE IN GEAR CASES

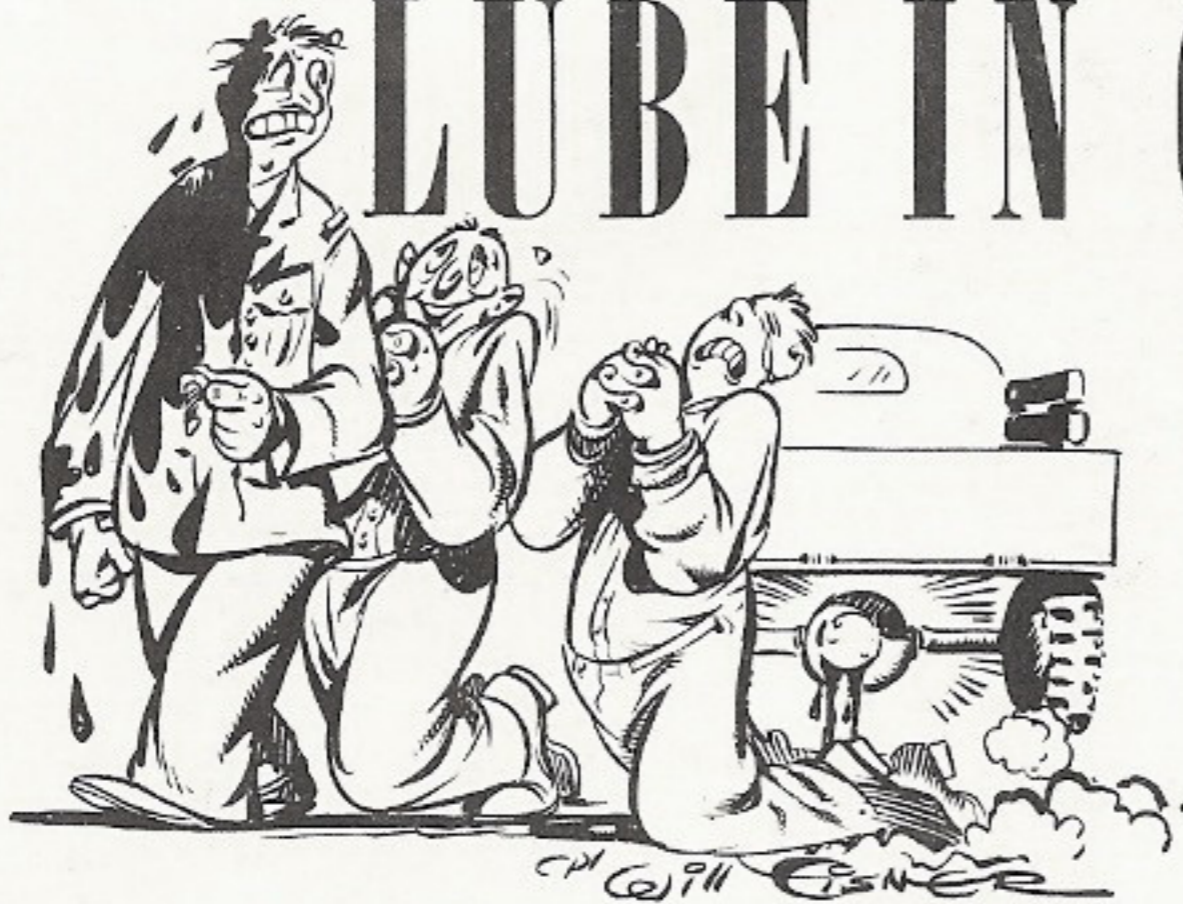

**Things your mother never taught you
about the behavior of lube in gear cases.**

The inspectors, the drivers and the 2nd-echelon greaseballs don't love each other any more.

Drivers and greaseballs don't like the way inspectors check the level of lubes in gear cases - in transfer cases, in transmissions, in differentials. The inspectors are fed up to the gills with the way lube is being installed in gear cases. (How we ever happened to get inspectors with gills in the first place will bear investigating.)

Anyway, the whole dispute settles down to a lack of understanding of how lubricant behaves in gear cases under various operating and climatic conditions.

For a while, the common complaint was overfilling of gear cases. Inspectors would peek into the inspection hole and the lubricant would leap out savagely at them.

The reason for this was - and is - that most maintenance manuals specify that gear cases are to be filled to the plug level. But this ignores

the usual practice of installing cold lube, in cold gear cases. After the truck is run for a while, the gears and lube warm up, the lube is whipped by the churning motion of the gears and the result is that the lube expands over the plug level. Along comes the inspector, opens the inspection hole and gets an eyeful.

The bitter words and feelings that arose from this situation finally gave birth to a solution: Most everybody got together and agreed that the gear cases should be filled to 1/2-inch-below-the-plug-level when cold, in order to allow for the lube expansion that takes place after the truck has been run for a while.

Of course, the shape of the gear case has a lot to do with this. For instance, a 10 per cent expansion of the lubricant in a wide shallow case like the differential raises the level only a little bit. In a narrow, deep case, like the transfer case, the same 10 per cent expansion

brings the level up to flood stage and it pours freely from the inspection hole when the plug is removed.

However, to meet all conditions, the 1/2-inch-below-the-plug-level is generally agreed upon as sufficient to allow for lubricant expansion.

Now although the bad blood between the inspectors, the drivers and the 2nd-echelon greaseballs has been somewhat purloated by this decision, all is still not peaches and cream. Many an inspector has of late snatched a truck out of a convoy fresh from a hard cross-country grind in all wheel drive, only to get his shoes bathed in hot oil as he delicately plucked the plug from the differential housing.

And, much as it hurts to say it, the fault in such cases lies with the inspector. It's the old lack of understanding of how oil behaves in a gear case. Instead of rushing blindly into an inspection of the truck, the inspector should reason thus: If gear oil that is installed cold to within 1/2-inch-below-the-filler-plug, warms up in ordinary operation to approximately plug level - then after tough operation, it must be expected to rise well above the plug level, and maybe pour out, right in der inspector's faze.

For two things happen to oil in a gear case. First, the heat of operation expands it somewhat. (Figure 1, which contains the results of tests run in the Texas Company's Beacon Laboratories, shows exactly how much.) Then

secondly, the churning of the gears in the case, whips the oil full of tiny air bubbles - a condition called 'foaming'. The air bubbles may be so tiny as to be invisible to the naked eye - nevertheless they're present and are responsible for the greatest part of the oil expansion.

Realizing these things, the thoughtful inspector will set himself down upon his haunches and wait for the oil in the gear case to return to normalcy - which should take about twenty minutes. Only in this way, will the levels of the oil in the various gear cases be checked fairly and accurately.

On the other hand, the drivers and the 2nd-echelon greaseballs are often at fault and may actually and unwittingly install too much oil in the gear cases. On a frosty morning, for instance, when gear oil is as stiff and sticky as cold taffy, a greaseball may insert the nozzle of his gun into the filler hole and fill it until he thinks he has it to the 1/2-inch-below-the-filler level. But, being stiff and not at all free-flowing, the gear oil may pile up at the rear of the gear case or on top of the gears. In this way, the quantity of lubricant installed may be enough to raise the level 'way over the plug level.

To avoid this kind of overfilling, the thoughtful greaseball will aim the nozzle of his grease gun down and just below the filler hole instead of thrusting it into the rear of the gear case where he can't tell what's going on.

Aside from the damage it does to the inspector's nervous system, an overfilled gear case is fraught with other dangers. There's the well-known damage it does to seals by expanding and busting through them, and then there's the lesser known damage it does to bearings.

At any rate, these things may be avoided and the love lost between the inspector, the driver, and the 2nd-echelon greaseball, may be happily restored if 1) the inspector waits for the foaming and heat expansion to subside before enscribing the the unfortunate driver's name upon the gig sheet and 2) if the driver and 2nd-echelon greaseball keep a sharp lookout in filling the various gear cases about the truck.

The 1/2-inch-below-the-filler-plug will take care of practically all operating and climatic situations; the inspector's discretion will take care of the extraordinary situations.

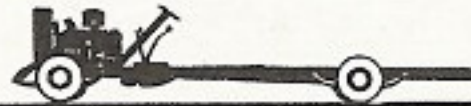

Observed Temperature	Per Cent Expansion
60°F.	0
100°F.	1.60
150°F.	3.66
200°F.	5.74
250°F.	7.87
300°F.	10.10

Fig. 1 - Heat is one reason why the lube in your gear cases overflows the plug level. The other reason is 'foaming'. (The expansion in the table is based upon the unit volume occupied by the oil at 60° F. For instance, if 1000 cc's of oil at 60° F. is warmed up to 100° F., it will occupy a volume of 1016 cc's and so on up the thermometer.)

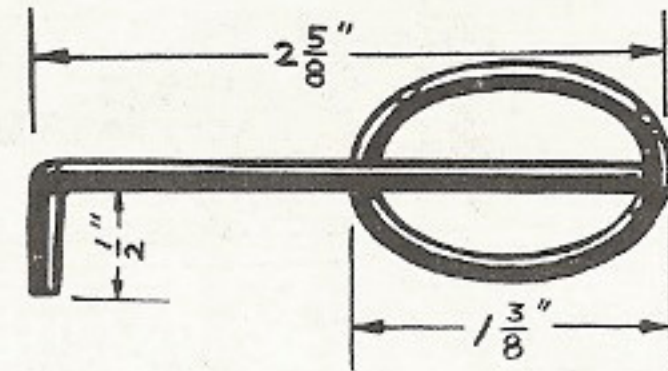

To help you install the gear oil to that 1/2-inch-below the plug level, here's a little gear-case dipstick made out of wire by Private Joy of the 307th Infantry and sent in by Major A. W. Samuels of the 94th Infantry Division.

Parts Exchange

When you go to requisition new parts, you've got to turn in old unserviceable parts (or else state some good "fair wear and tear" reasons why not).

How do you guarantee that somebody won't accuse you of not turning in the old part? Do you get a receipt? What kind of a receipt?

According to Major Haas of the Supply Branch, parts exchange is being handled in this simple and effective way in the field:

A man ordering a new part, uses the same identical requisition he's ordering on, to state that he's turning in an old part. He puts down the name of the old part and any necessary explanations. Then he turns in the old part and the requisition to the issuing office. The issuing office signs for the old part on the back of the requisition and ships out the new part to the using organization. This way the using organization has a record that it turned in an old part, and can't be charged with being overstocked.

And the requisition, which must be used in ordering anyway, does double duty as a receipt, and a separate form is done away with.

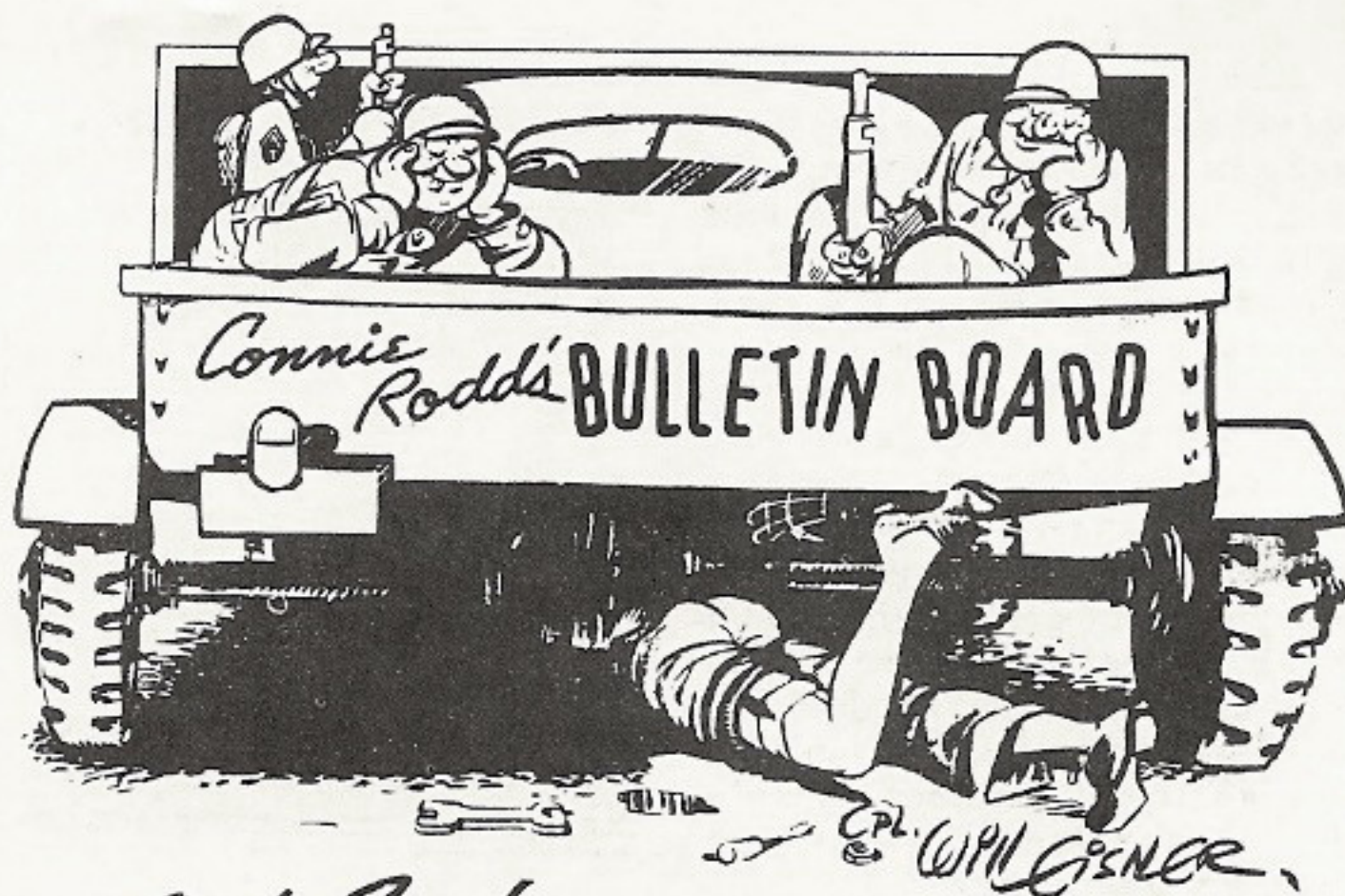

Oil Seals

I take off my fur-trimmed fatigue hat to whoever in the Armored Forces, Fort Knox, Kentucky, wrote the following shrewd observation:

There is a shortage of oil and grease seals. In order to conserve these important items, motor officers and mechanics must recognize the difference between seepage and leakage. No oil seal can be made a perfect fit to a revolving shaft. Therefore, some showing of gear oil around a seal or joint is to be expected and does not necessarily indicate need of seal replacement.

Proof of leakage is the presence of puddles of lubricant beneath a vehicle that has remained standing, or low level resulting from major loss. When actual leakage occurs, seal replacement is necessary, but look for over-lubrication first.

Throttle Levers

In our November scoop which broke the news about sticking throttle levers on 3/4-ton Dodge carburetors, we included a temporary repair to help you get going in a hurry. This called for putting a paper gasket between the two metal washers on the throttle lever.

This month, along comes Sergeant Walter E. Schumacher, 308th Medical Battalion, Camp Atterbury, Indiana, with an improvement on the original temporary repair.

He suggests that the paper gasket be well oiled before it's put in place. Even though the oil will eventually dry out of the paper gasket, due to the heat from the manifold, it makes the temporary repair a lot more effective. We should have included it as part of our story.

However, this is still only an emergency repair - get your replacement assembly from Fargo Corporation as quickly as possible and install it. (See story on page 226 of the November *Army Motors*.)

* * *

Insignias

Sad news for all you would-be Walt Disneys. No longer will you be able to adorn your trucks with your own organizational designs. AR 850-5 Paragraph 4, e, which authorized organizational designs has been rescinded by Change No. 3, AR 850-5 dated November 12.

If you've already got some of your vehicles tricked up with fancy doo-dads, get out the O.D. and make with the paint brush.

Gaskets

If you read our little story on 'Scrambled Gaskets' in the November issue, you might have been disturbed by the 'plain gasket' shown in Figure 1 of that story (Fig. 1 below). This gasket, we said, is used between the carburetor and the governor.

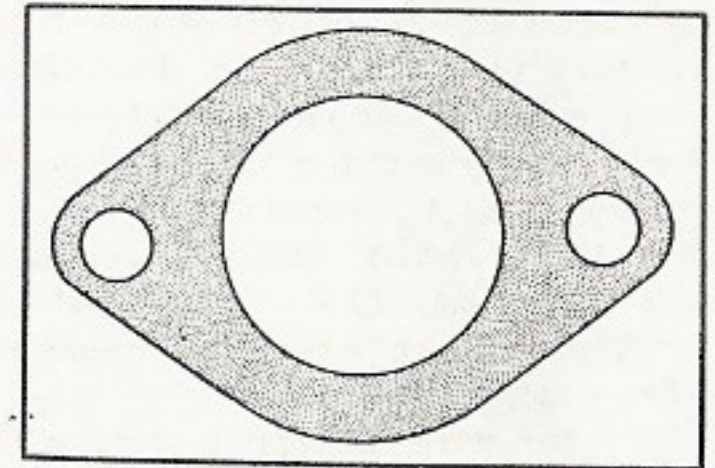

FIG. 1

But this is only part of the explanation. We should have said that this sort of plain gasket can't be used where there's a vacuum-operated power jet. When there's a vacuum operated power jet,

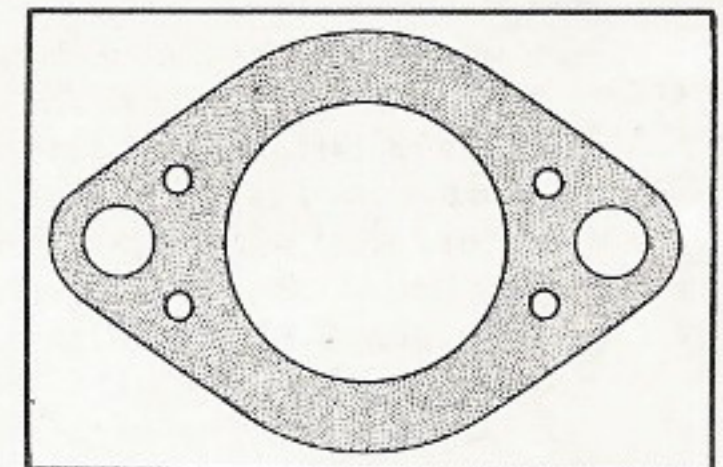

FIG. 2

the gasket must have either four little holes in it (Fig. 2) or two internal slots in it (Fig. 3). These holes or internal slots allow the vacuum that operates the power jet, to travel up to

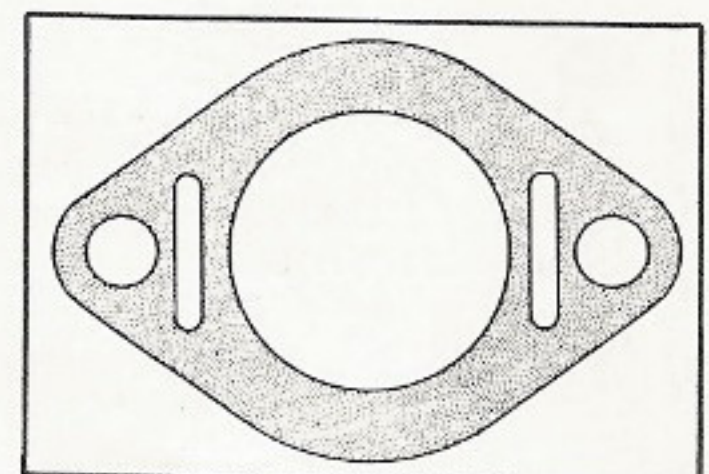

FIG. 3

the power jet. If the gasket is plain as was shown in the story, it blocks off the vacuum to the power jet and the power jet can't operate properly.

The only time the plain gasket is used between the carburetor and the governor, is when the carburetor uses a metering rod instead of a vacuum-operated power jet. The carburetor on the Ford and Willys 1/4-ton uses a metering rod - and so, of course, may use the plain gasket between the carburetor and the governor. On other trucks, like the 2-1/2 ton GMC and 3/4-ton Dodge, the carburetor has a vacuum-operated power jet. Here the gasket with the holes or internal slots as shown in Figures 2 and 3 must be used between the carburetor and governor.

* * * *

I don't like to keep boring you about gaskets, but two more Carter carburetor men were in here the other day crying on my soft, white shoulder about how gaskets are still being used in the wrong places.

The gasket-with-four-slots (arrow in Fig. 4) they complain, is being used up

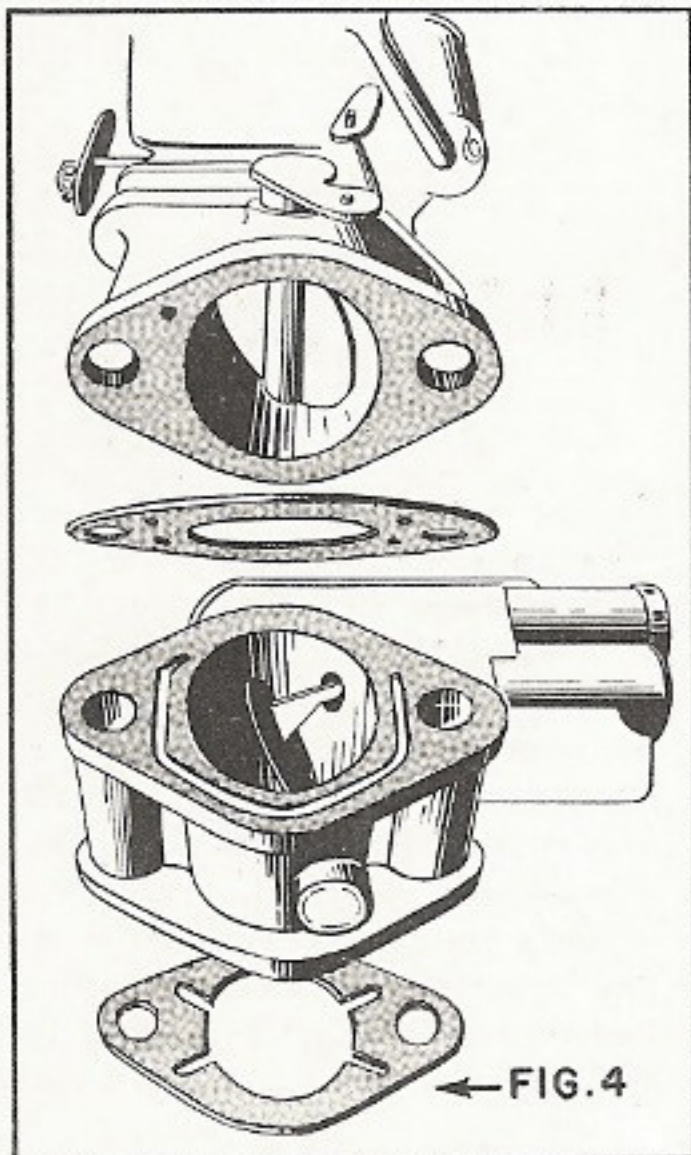

above where the gasket with the four holes belongs, and the gasket with the four holes is being used down below (next to manifold) where the gasket with the four slots belongs.

As my old Aunt Sleazy used to say, "Tsk, tsk."

Using the gasket with four slots between the governor and the carburetor (when the carburetor has a vacuum-operated power jet) allows the power jet to pick up its vacuum in the area between the butterfly valves of the carburetor and the governor. And this ain't fair because the power jet operates when there's a low vacuum in this area - which low vacuum occurs when the governor closes its valve to cut down the speed of the engine.

So there you have the governor trying to cut down the speed of the engine, and the power jet furnishing a richer mixture of gasoline to raise the speed of the engine. One fights the other and precious gasoline is being spewed all over the lot.

You fellas working on carburetors keep your eyes open. Make sure the gasket with four slots (arrow in Fig. 4) is never used anywhere but *between the manifold and whatever's placed next to it* (either the governor or carburetor), and that the gasket with the four holes is up there *between the governor and the carburetor* where it belongs.

* * *

Clutch Disc

A couple cases of trouble in shifting gears on half-track vehicles have been reported. In some instances inspectors find the clutch-disc assembly (C-85631) out of true enough to cause a continual drag on the disc. Sometimes the drag is overcome by the resistance of cold oil in the transmission while in the worst cases the drag is no-

ticeable even when the oil is cold.

This trouble is often diagnosed as transmission-gear trouble and is treated as such. But the remedy is to true-up the disc. Put the disc assembly on an arbor or master gear, swing the assembly between centres on a lathe, and using the tool post grinder, take a cut across each face of the lining until the run-out of the clutch disc is less than .008 inches. This allows the clutch pressure plate enough clearance to release the clutch disc. If the run-out of the clutch disc is more than .030 inches, don't try to true it up as it'll require the removal of too much of the facing material. Change the clutch-disc assembly.

* * *

Pinched Fuel Lines

Don't know whether you've been bothered with broken fuel line trouble but on the 3/4-ton Dodge Weapon Carrier and the 37 mm Gun Motor Carriage, M-6, the trouble may be headed your way. It seems that on these vehicles the

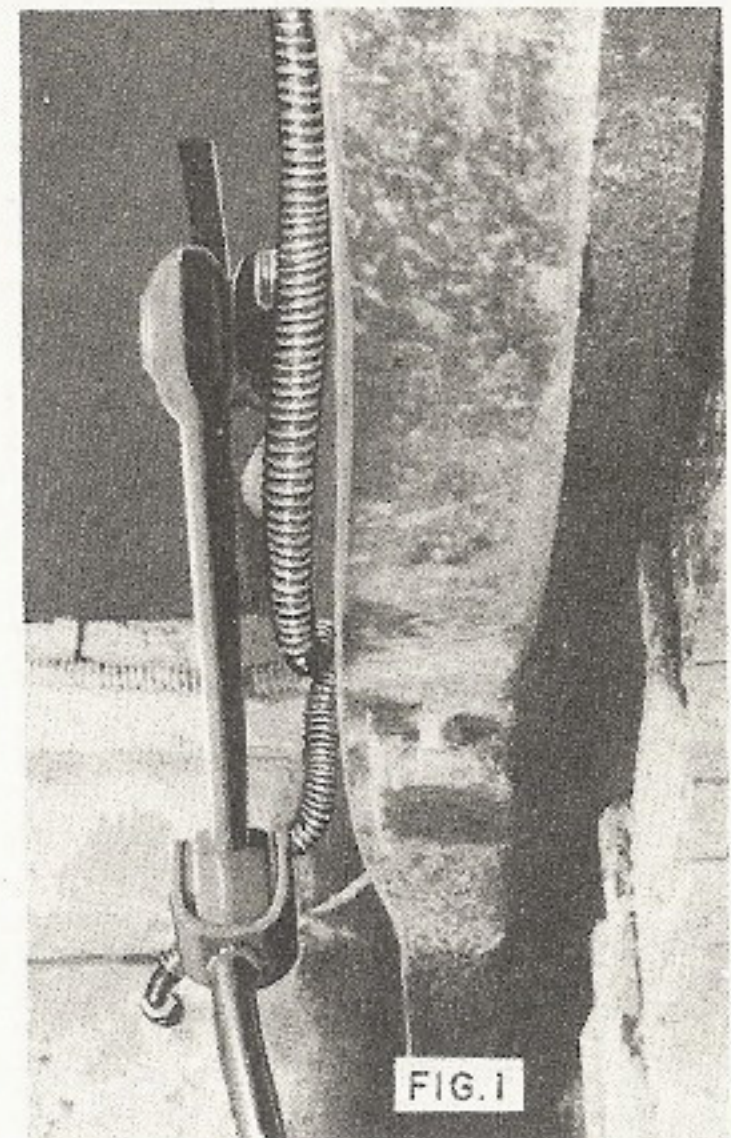

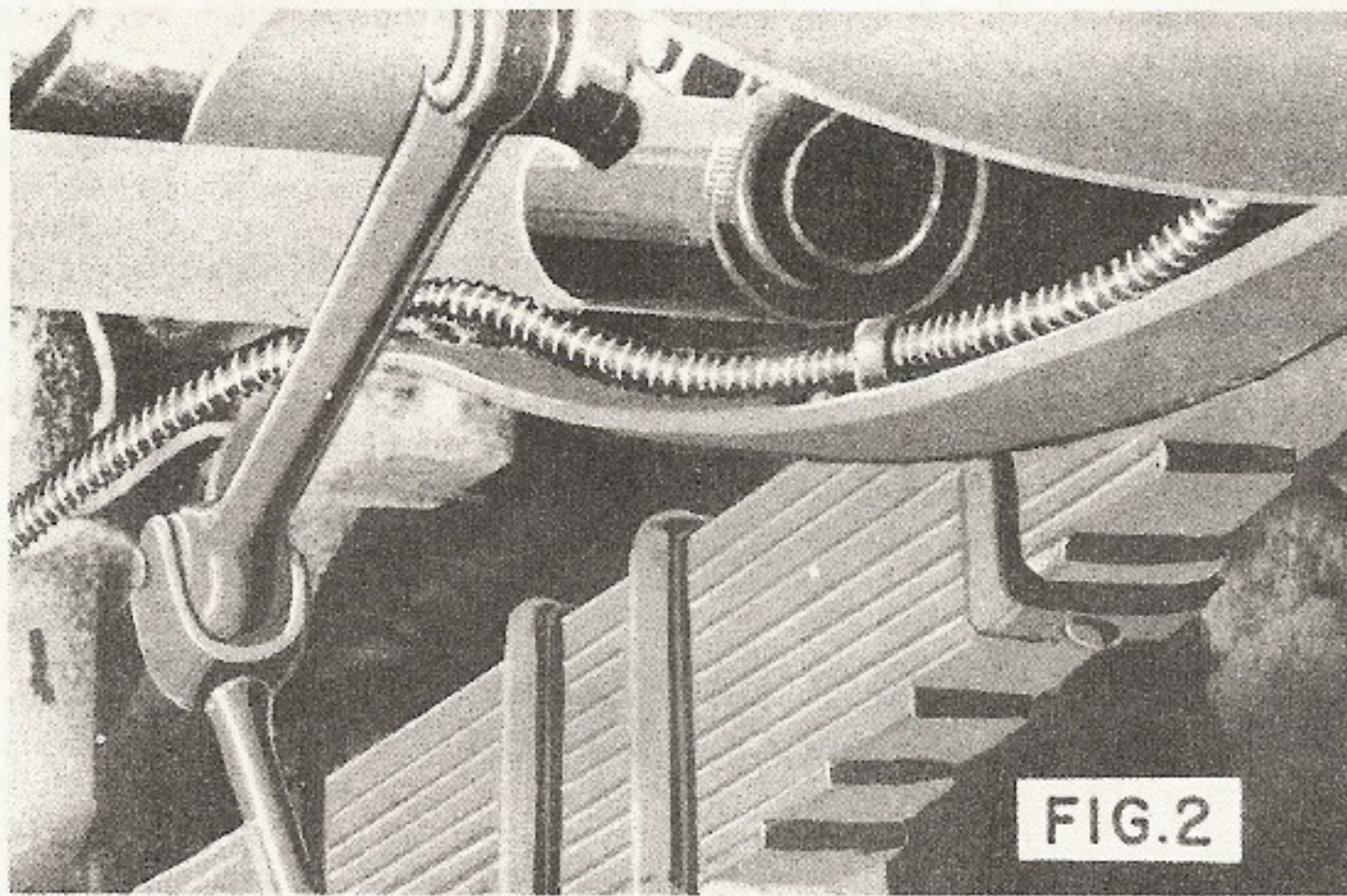

fuel line passes between the shock-absorber arm and the frame side rail (Fig. 1). With the vehicle in operation, the shock absorber arm goes into action and pinches the fuel line against the frame. The line may be cut at any time.

Make the correction the way the factory does it on new vehicles coming off production lines: Weld a little guide hook (Fig. 2) on the inside of the frame side-rail and press the line in so that it runs along this channel.

Thrust Block

Don't be surprised if a Fargo representative descends on your outfit and supervises a slight change on your 3/4-ton Dodges. The change is in the thrust block that contacts the ring gear in the differential. The present thrust block is bronze and has been wearing out too quickly. The new thrust blocks are a hard, concentrated-grain-structure steel.

run the wires through. The sharp ends will sooner or later chafe through the wires making the blackout lamp merely an ornament. Mr. Kiene suggests that the holes be drilled large enough to take a piece of windshield-wiper hose. Install the hose and the wires have a protected channel to run through.

Chafed Wires

The 30th Infantry Division's Motor Bulletin carries a good idea by J. T. Kiene, Automotive Advisor, 30th Signal Co. Mr. Kiene notes that in installing the new blackout driving lamps, it's necessary to drill either the radiator shield or the fender skirt to

Grease Spots

Corporal Chester G. Pehl, Maintenance Battalion, 14th A.D., Camp Chaffee, Arkansas, passes on an improvement on our procedure for removing grease spots from O.D. paint as outlined in an item in Half-Mast's Department.

Corporal Pehl suggests that you work on an entire panel when washing out grease spots so that even though the paint becomes slightly lighter in color it will be hardly noticeable as compared with

just washing out the spot, which would in time make your vehicle look like your grandpappy's dapple-grey horse.

Storing Tires

If you've been leafing through TM 31-200 (Maintenance and Care of Pneumatic Tires and Rubber Treads) lately, you may have run across the suggestion that stored tires be painted with rubber paint or some synthetic rubber coating.

And many of you have wondered what the Federal Stock Numbers of these paints or coatings were, and where you could obtain them. The answer is simply that you can't.

No satisfactory paint or coating has been found, and so the revised TM (which is now in the works) will not suggest that stored tires be painted.

A cover or wrapping of heavy canvas, or a similar material will do for tires stored on the outside and we'd say the same goes for tires stored on the inside.

DUTY Rosters

In our October article on "How to Keep Preventive Maintenance Records on Duty Rosters," We forgot to mention that the little circles around some of the symbols in the illustration merely indicate that the PM servicing so marked was performed out of turn. As when after a particularly hard run, the truck gets an immediate servicing, instead of waiting for the appointed day.



Here's an evil one: the big tire-conservation program is being sabotaged right under our very noses. And all for lack of care of a little brass stick about a foot long. We mean the driver's tire gage. It's thrown helter-skelter into the vehicle tool-box to be battered around by heavier, rougher tools, it's frequently banged or dropped on the ground, and generally given less care than an old truss. For this reason, many of the driver's tire gages in the field are almost worthless as an instrument for checking air pressure in tires.

Next month the Army Motors will carry a short course on the appreciation of the tire gage in the hope that if you understand what's inside it, you'll take a lot more care of it. (Meanwhile, get the tire gage out of that tool box and hang it up in the cab where it'll be out of harm's way.)

* * *

Reports have been sneaking in here about the five-gallon gas can. Most complain about the water that's allowed to collect in them, later to be poured into the vehicle fuel system. Others comment on the filthy condition of the insides of the can: lots of rust is reported, some 'grey dust' (which is zinc oxide - some of the cans are galvanized), plenty of oil and gum, and various other residues.

Imagine what all this stuff does to the fine passages in a carburetor when it creeps

by a fuel filter that's carelessly serviced!

Did we hear somebody ask why the @*!!* don't we work up a gas can that won't rust - or some easy process that'll enable the cans to be serviced and maintained once in a while? (We're working on that now, we'll try to give you the answer next month, Fate and the Technical department willing.)

* * *

We're happy to hear that in the 578th Field Artillery Regiment at Fort Bragg, all motor transport personnel - drivers and mechanics - are not required to do K.P. or guard duty.

This strikes us as a good way to show the men that their job is considered important enough to exempt them from life's little annoyances.

* * *

They say that a violent (or even medium violent) sand storm in the desert blasts the paint off our vehicles and leaves them clean as a plucked chicken. Looks like the brownies in the Chem Lab will have to work up a tougher hide for truck fuselages.

* * *

The Chem Lab is also looking for something to plug up bullet holes in radiators, something temporary to keep a truck going long enough to get out of a hot spot and

maybe even back to where it can get a more permanent repair.

They've tried all the stand-bys including Mother's Old Home Remedy: horse manure in the radiator, but a bullet makes such a big hole that anything that'll plug the hole up, will also plug up all the small passages in the cooling system.

Best thing to date is water-pump grease. It does a good job on straight bullet holes, but it's too hard to apply to slanting bullet holes.

Anybody got any ideas?

* * *

We got hauled up on the carpet for saying last month that there ain't no sech animal as TM 10-545. And then some sly devil in Washington wordlessly sent us a little, brown book clearly marked 10-545, Motor Transport Inspections.

But you can't insult us - we're too ignorant.

(P.S. TM 10-545 is being revised and will come out entitled, TM 9-2810, 'Motor Transport Inspections and Preventive Maintenance Servicing.')

* * *

H. C. Parker, Automotive Advisor, 119th Infantry Reg't, bangs his fist on the table and declares that too many brass gas-and-oil-line fittings are being ruined. He blames it on the use of pliers for breaking the fittings loose from the lines.

Do it this way, recommends Mr. Parker: When you remove fittings from a carburetor, fuel pump or any other unit, get a hold of a male fitting and screw it into the female fitting. This will enable you to use an end wrench which won't collapse or otherwise damage the fitting.

But don't use pliers - besides breaking up the comparatively soft brass fittings, they make the job too hard.



GMC CRANKCASE VENTILATING SYSTEM

Four big changes on the "270" engine will make an even better truck of your 2½-ton GMC.

The '270' engine which powers your 2 1/2-ton GMC (model CCKW 352 and 353) has just hit the big-change jackpot.

An Ordnance 'Field Service Modification Work Order' (FSMWO G-508-W1 dated January 2nd) announces four separate and distinct changes which will make your 2 1/2 ton GMC a better truck to live with.

The four changes are (1) a new air-cleaner seal which will keep air from sneaking in under the base of the air cleaner thereby feeding the engine dirt, dust and other air-borne impurities; (2) a strong return spring on the choke wire which will cause untold suffering among those slap-happy souls who like to ride with the choke button out; (3) an improved water by-pass system which will help do away with the overcooling responsible for the rust (especially under the valve covers) and sludge formation down in the crankcase; and (4) a complete and elaborate system of crankcase ventilation which should get rid of most of that condensation which has been the chief cause of sludge in this particular engine.

Materials for the changes will be furnished in kits, and the work - a 5 1/2-hour job

for a qualified automotive mechanic - is marked with a red band which in Ordnance lingo means "it will be done immediately."

The kits, which contain the forty-nine separate parts necessary to make the change, are now available from the Fort Wayne Ordnance Motor Supply Depot, Fort Wayne, Detroit, Michigan. Order the kits for your '270' engines by the following name and number: "Type 270 Engine Modification Kit," GMC Piece Mark SSL-1175. (In the old days we would have called the 'piece mark' the part number.)

Here's a list of the technical manuals for the trucks equipped with the '270' engines to be modified.

TM	10-1243
10-1105	10-1265
10-1147	10-1269
10-1215	10-1401
10-1229	10-1451
10-1231	10-1501
10-1241	10-1563

Following are the new parts to be installed and a short, sweet description of how they are to be installed:

Air Cleaner Seal

The new air-cleaner seal is necessary because in the past, the air-cleaner was

often wrestled off the carburetor without the clamp first being loosened. This distorted the lower part of the air cleaner and created entrances where the air crept in without first going through the cleansing oil bath. Also the unsealed slots at the base of the air-cleaner let air sneak by.

The new 'air-cleaner and clamp assembly,' Part No. 1543010 (Fig. 1) comes along with the rest of the material in the SSL-1175 kit and is installed as follows: Remove the air cleaner from the carburetor, drain oil, disassemble the air cleaner and wash the reservoir with kerosene.

Take off the present air-cleaner clamp by bending the clamp back, breaking the spot weld (or removing the rivet) with a screwdriver. Be careful, in removing the clamp, not to distort the throat of the air cleaner - otherwise you'll have to reshape the throat by placing it over a two-inch pipe or mandrel and banging out the distortion.

Slip the new air-cleaner-clamp-and-seal assembly on the air-cleaner base. Be sure the seal covers the slots in the air-cleaner mounting flange and that the ends of the seal are between two of these slots. This will prevent air being sucked between the ends of the seal, in through a slot and on into the carburetor.

Now mount the air cleaner, with the clamp attached, on the carburetor. Tighten the clamp up well to make it airtight.

Fill the air-cleaner reservoir to 'Oil Level' mark with the proper oil. Wash the filter element in kerosene, dry, and dip it into fresh engine oil. Reassemble the air-cleaner making sure the gaskets are in good condition.

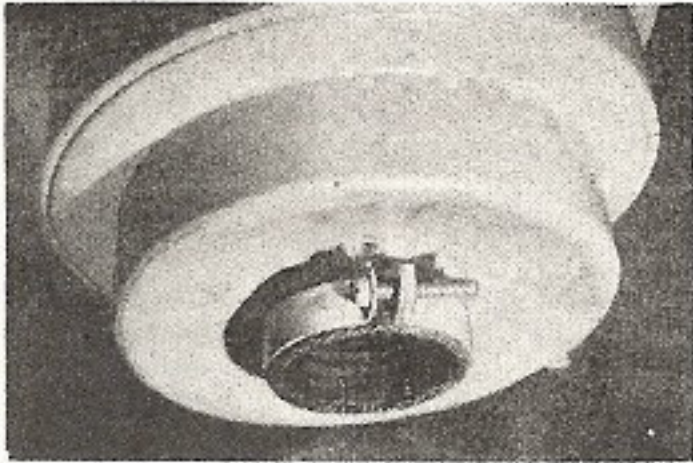

Fig. 1 - The new air-cleaner clamp.

Carburetor Choke Control

The carburetor choke control as we have already explained, is a little idea to keep drivers from running along with the choke button out. The driver pulls the button out and if he doesn't hold it out, it jumps right in again. Sort of does the driver's thinking for him.

Following are the parts furnished in the kit for this installation:

Part	Part No.
Choke-Wire Assy.....	1901849
Carburetor-Choke-Ret.	
Spring-Kit Assy. ...	2137528
(includes following four parts)	
Choke Return Spring..	2179155
Choke Return-Spring	
Bracket	2179154
Bracket Screw	2143833
Lockwasher	106496

Install the new return spring this way (follow Figure 2):

Take off the air cleaner. Loosen choke-wire lock screw. Take out the present choke wire and discard.

Run a 3/16-inch drill into the choke-wire rod guide

approximately 1-1/2 inches deep in from the instrument panel. This will knock out the indentation or blister on the inside of the rod guide which might otherwise drag on the rod in the guide and prevent the return spring from pulling in the choke button.

Install the spring bracket in the location shown, using the new screw and install spring from bracket to choke-wire lock screw.

Lubricate the new choke wire and casing and install, making sure the wire moves freely in the casing.

Push the choke button all the way in and turn it so that the word 'choke' is horizontal. Take a look in the carburetor to be sure that the choke valve is in the full-open position. Insert the wire in the lock and tighten lock screw making sure the choke button is tight against the dash.

Test the installation by having somebody pull the choke button out - the choke valve should be fully closed. Tell

the man at the choke button to let go of the choke button -- if the spring pulls the choke valve into the full-open position, it's O.K.

The route from the return spring to the choke button must always be clear and free of friction or sharp edges to guarantee smooth operation.

Water By-Pass

One requirement for military vehicles is that a vehicle be backed up a 65% grade and idled for fifteen minutes without losing water from the cooling system. On the GMC - and certain other vehicles - this calls for a by-pass tube at the rear of the engine where steam is formed during such operation, in order to relieve the pressure of the steam and keep it from pushing water out through the overflow pipe. This 'steam-relief tube' on your '270' engine, leads into the radiator top tank.

However, with this design, water by-passes the thermostat and runs on down through the

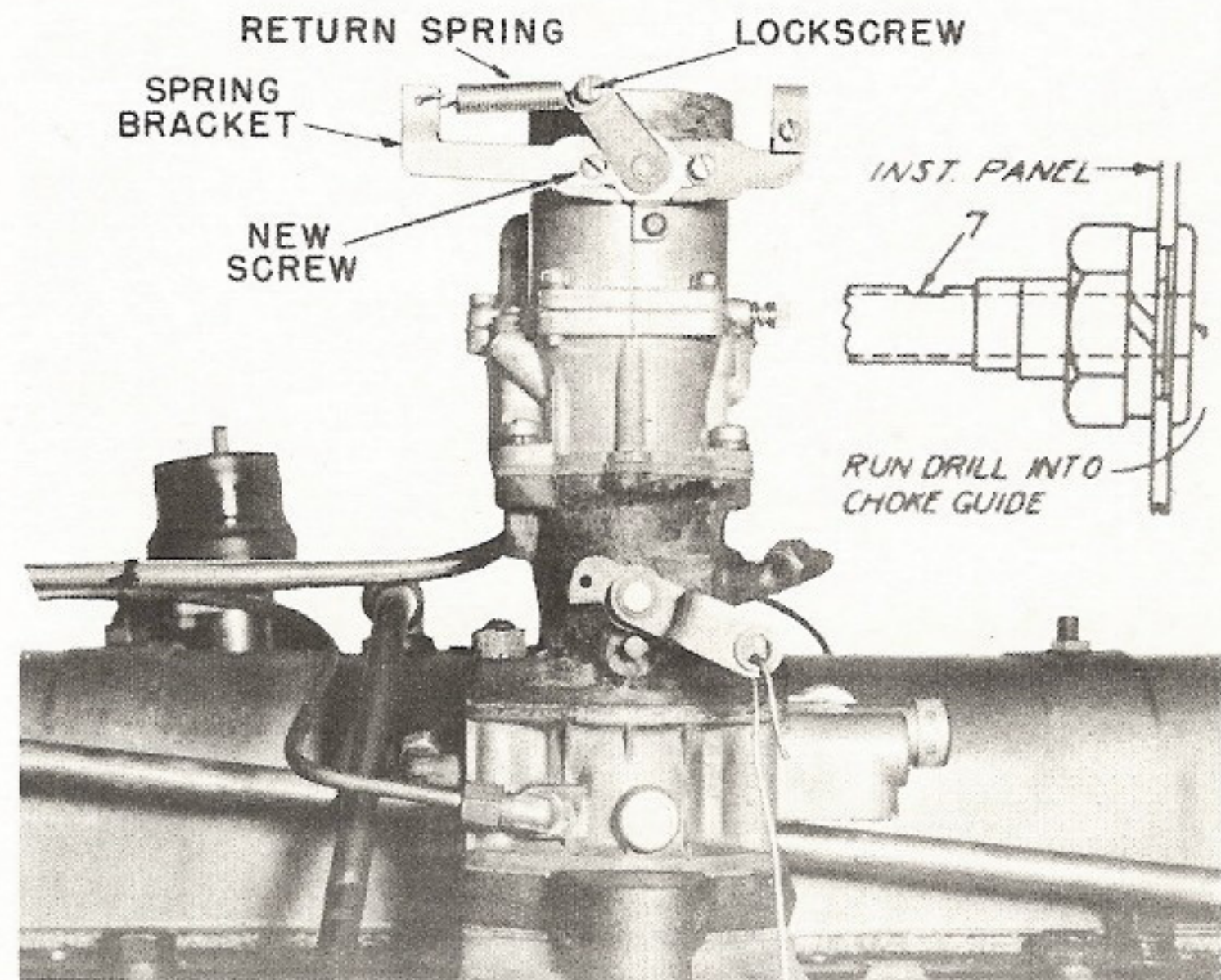

Fig. 2 - The new return spring pulls the choke button in.

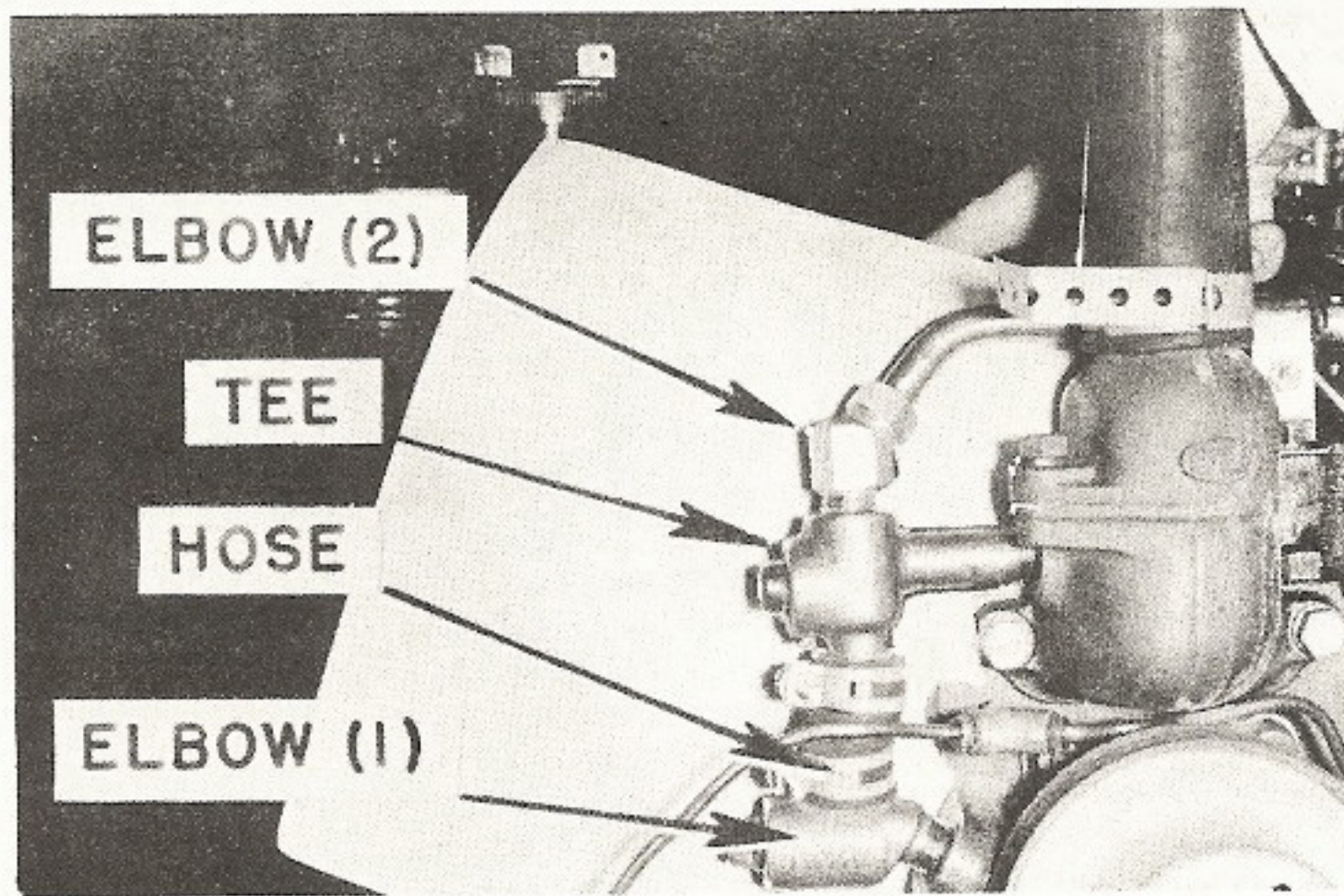

Fig. 3 - The new by-pass circulates the water through the engine during warm-up; stops overcooling.

radiator core and, in temperatures below 60°F., leads to overcooling.

To stop this overcooling, an improved water by-pass has been installed on the later '270' engines. This by-pass, instead of sending the water through the radiator where it is automatically cooled, leads it into the water pump from which it is circulated through the engine and allowed to rise to a decent temperature during the warm-up period.

If the new improved water by-pass has not already been installed on your '270' engines, you will proceed to install it now. The SSL-1175 kit will furnish you the following parts:

Name	GMC Piece Mark
Cylinder-Head-Water By-Pass-Tube Assy....	2137477
Cylinder-Head Water-By-Pass-Tube Rear Elbow	2137281

Cylinder-Head Water-By-Pass-Tube Front Elbow.....	143340
Water-By-Pass-Tube Clip	2137376
Clip Screw.....	160045
Clip-Screw Nut.....	103088
Clip-Screw-Nut Lockwasher.....	106497
Cylinder-Head Water-By-Pass Tee	2137478
Water-Pump By-Pass Inlet Elbow.....	2137713
By-Pass Tee to Inlet-Elbow Hose	2137582
Two Hose Clamps.....	178306
Cap	2175167
Clamp.....	178302
Water-Pump-Elbow Pipe Plug	103885

Before making the installation, drain the cooling system and remove the following parts from the engine:

1. Steam-relief tube and hose

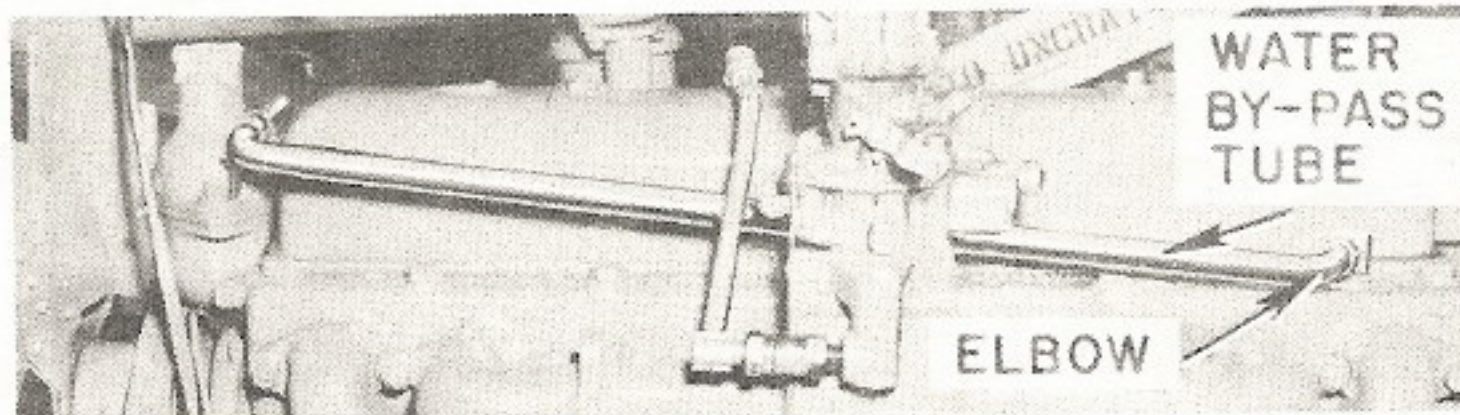

Fig. 4 - The by-pass tube running from elbow to elbow.

2. Steam-relief-tube support bracket.
3. Relief-tube-to-cylinder-head connector.
4. Pipe plugs in right hand side of the thermostat housing and the water pump.

Close the steam-relief-tube opening in the radiator upper tank by installing a composition cap (Part No. 2175167). A metal clamp (Part No. 178302) holds this cap in place.

Since this installation involves a lot of pipe fittings, don't forget to coat the threads with Permatex to prevent leaks.

Here's the installation (follow Fig. 3):

Disconnect the oil-filter-to-engine oil line, at the engine. This will give you more freedom in installing the following parts: Install the elbow (1). Remove the thermostat housing, (try not to damage the gasket - if it's shot, cut a new one or use Permatex #2 to seal the joint). Screw tee in housing and install hose and clamp on tee.

Put the thermostat housing back on the engine, and tighten the hose clamps. Connect up the filter oil line (you'll have to pass it around the elbow-hose-tee assembly). Now screw the 3/8-inch plugs you took out of the water pump and thermostat housings, into the elbow (1) and tee.

Install the elbow (2) in top of the tee. Figure 4 shows the location of the hole at the rear of the cylinder head that had been previously tapped for the old steam-relief tube. Install elbow (Part No. 2137281) in this hole.

Connect the by-pass tube in Figure 4 between these two elbows: The one at front and the one at the rear of the engine.

There's a clip (Fig. 5), to support the by-pass tube in the kit. Install this clip under the bolt that's on the

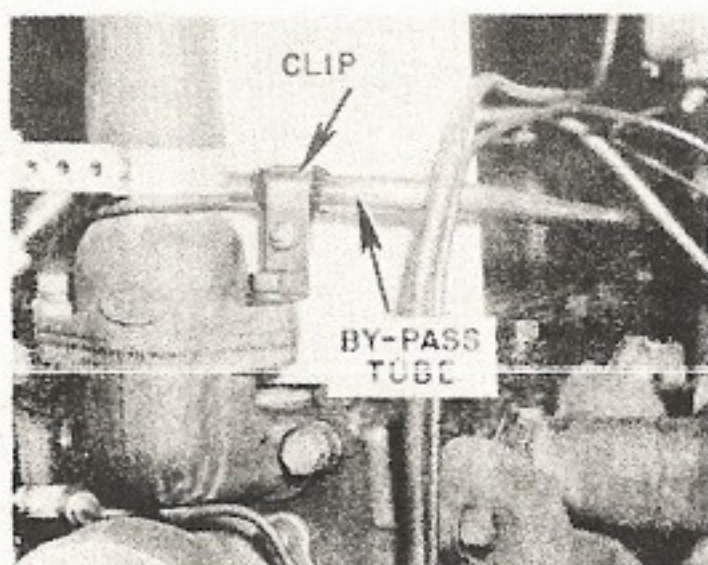

Fig. 5 - The clip supports the by-pass tube.

left side of the thermostat housing. Make sure the insulator that's furnished, is between the tube and clip.

Fill the cooling system and check for leaks at the connections you've just made.

Special instructions for engines with two oil filters: Disconnect engine-to-oil-filter oil line at the filter. Install headless pipe plug, Part No. 103885 in elbow (1) (Fig. 3). Install the elbow in the water pump, connect the oil line to the filter and continue with the installation as outlined above.

Special instructions for use when there's an electric-temperature-gage engine unit mounted on a tee in the right side of the thermostat housing as shown in Fig. 6:

Remove the temperature gage from the tee. Remove the copper by-pass line from between the tee and water pump and discard. Remove the reducer from the water pump, and the tee from the thermostat housing, and discard. Install the temperature-gage engine unit in the new by-pass tee where the 3/8-inch pipe plug would normally be installed.

Because of the difference in the thread size, you'll have to drill out the 3/8-inch threads with a 23/32-inch drill and tap with a 1/2-14 standard pipe tap (Fig. 7). *Important* - run the thread only deep enough to permit the gage to screw in about three or four threads deep - any deeper might cause the gage to block off the flow of water through the tee.

Proceed with the installation as outlined above.

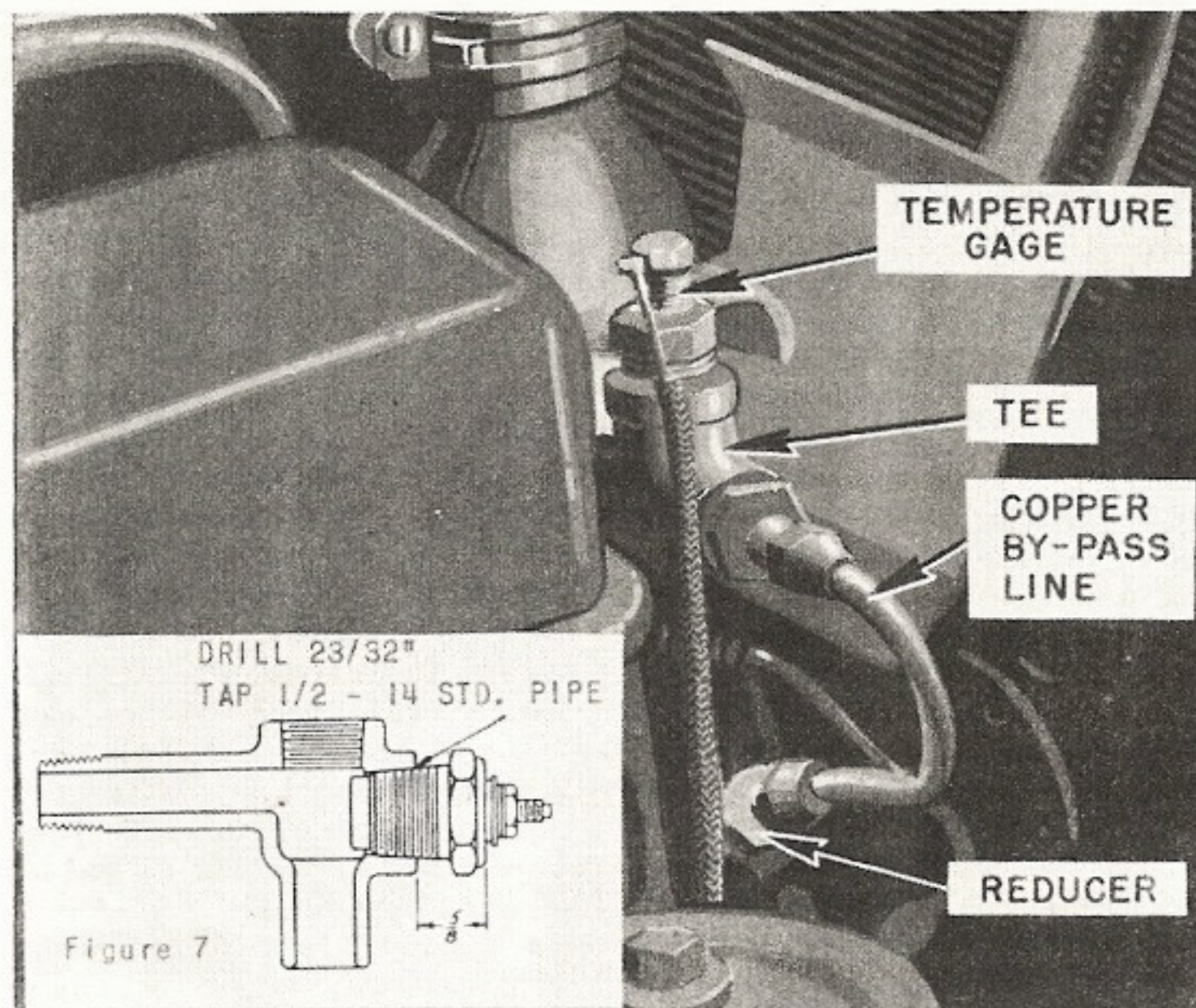

Fig. 6 & 7 - An electric temperature gage mounted on a tee in the right side of the thermostat housing.

Crankcase Ventilator

Out in the field, vehicles are often run in fits and starts. A driver will jump in his truck and run for a mile or so then stop and park. Another errand may require him to drive two or three miles and stop and park again. This sort of thing doesn't allow the engine to get hot enough to drive off the condensation that collects in the various parts of the engine, especially the crankcase.

Any good mechanic will agree that the collection of water in the crankcase, if not evaporated off, can become considerable.

For this reason, the crankcases of GMC '270' engines in production are now equipped with a ventilating system. This ventilating system is part of the SSL-1175 kit and you're to install it on your GMC '270' engines that don't already have it.

The new ventilating system works this way: With the engine operating, air is sucked in through the miniature-oil-bath air cleaner (Fig. 8) which is mounted by means of a bracket on the oil-filler pipe. This filtered air then passes through the engine and is drawn out through the elbow in the top of the engine valve cover. From there it is drawn along the tube (Fig. 9), around through the elbow, through the ventilating valve mounted at the carburetor, on into the intake manifold through the carburetor adapter (or 'tee' in case where the hydrovac system is hooked up to the center of the intake manifold).

Vacuum from the intake manifold is the power that sucks the air through the system just described.

Following is the list of parts you'll find in the kit for installing the ventilating system on those of your '270'

engines that don't already have it:

Name	GMC Piece Mark
Carburetor-to-Intake-Manifold Adapter	2137520
Carburetor-to-Intake-Manifold Front Stud	2137521
Carburetor-to-Intake-Manifold Rear Stud	2103349
Ventilator-Valve Assembly	1542867
Valve-to-Cylinder-Head-Cover Tube Assembly	2137523
Ventilator-Valve-to-Cylinder-Head-Cover Tube Elbow (on valve)	137424
Ventilator-Valve-to-Cylinder-Head-Cover Tube Elbow (on cover)	2137524
Elbow Gasket	853269
Elbow Lock Nut	2137530
Elbow-Lock-Nut Washer	115554
Oil-Filler-Pipe-and-Flange Assembly	2137525
Crankcase-Breather-and-Oil-Filler	1543015
Assembly (includes following 5 parts):	
Oil-Filler-and-Breather-Housing Assembly	1542948
(Includes the following 2 parts):	
Breather Air-Cleaner Gasket	1543016
Filler Cap	1542973
Air-Cleaner-Oil-Base-and-Stud Assembly	1542965
Breather-Air-Cleaner-Element Assembly	1542966
Breather-Housing-to-Ventilator-Pipe Gasket	2137526
Breather-Housing-to-Ventilator-Pipe Bolt-and-Lockwasher	
Assembly (2)	191046
Cylinder-Head-Cover-Cap Assembly	1304628
Cylinder-Head-Cover Closure Seal (2)	2137527
Oil-Filler-Pipe Plug	103865
Spacer-to-Manifold Gasket	2135995
Spacer-to-Governor Gasket	2135995
Governor-to-Carburetor Gasket	2136304

Here's the installation: OIL BATH AIR CLEANER AND OIL FILLER PIPE

Take off the present oil filler tube and toss into salvage. Install 1/8-inch pipe plug in the new filler tube and install the tube in the engine.

Place a block of wood on top of the tube and tap the wood lightly with a hammer. Don't use the hammer on the bare tube -- you'll bend it out of shape. Another thing: See that no dirt falls down the tube into the engine.

The top of the filler tube must be perfectly level when installed in order that the air cleaner will be on the level when it's installed.

Install the air cleaner.

This air cleaner, incidentally, is serviced just like the regular carburetor air cleaner. Dip the mesh

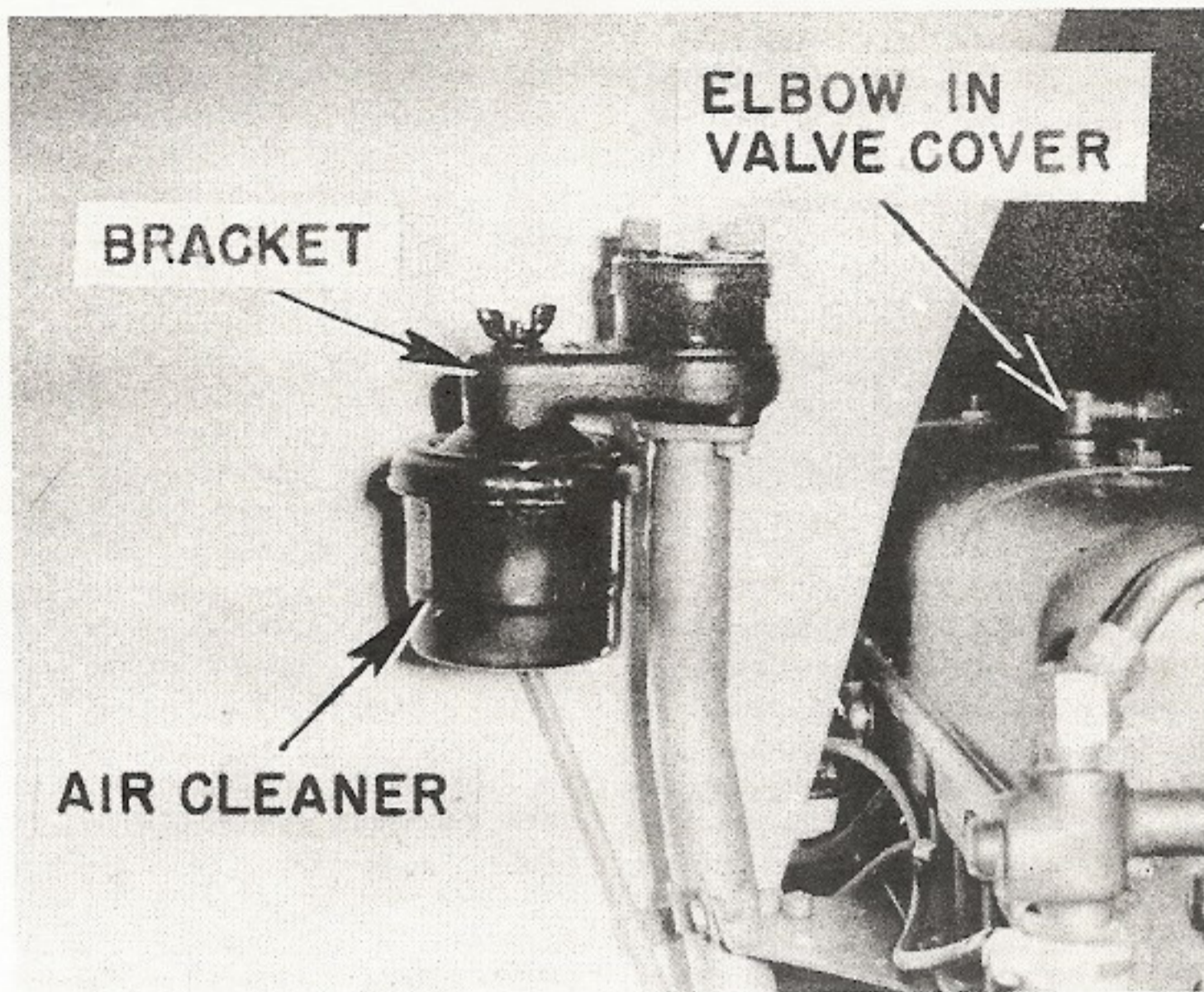

Fig. 8 - The little oil bath air cleaner.

element in SAE 50 engine oil and let the surplus drain off. Fill the oil reservoir in the cleaner with the SAE 50 oil up to the 'Oil Level' stamped on the side of the cleaner.

A good rule to remember at any time, is to cover both air cleaners - ventilating and carburetor - whenever you're washing your trucks. This will keep water from entering the engine.

REWORKING THE VALVE COVER

Two types of covers have been furnished on the '270' engine (Fig. 10): One with two louvres, the other with a small air cleaner. Both types of openings in the valve cover must be closed. In the case of the louvres, remove the valve cover and close both louvres by inserting a piece of composition material (Part No. 2137527) in each and compress the louvre with a ball peen hammer. Don't try to close the louvres by brazing. Some of these valve covers areterne-plated and brazing will destroy the plating. Be sure the valve cover is properly supported while you work so it won't be bent or other-

wise distorted.

To close the air cleaner type of valve cover, use the cap (Part No. 1304628) that is furnished in the SSL-1175 parts kit.

A hole must be made in the valve cover for the ventilating-tube elbow. Draw a template according to the directions in Figure 11 and position it over the hold-down bolt holes to locate this hole. Prick-punch, then drill or file a 3/4-inch hole. (The template calls for a 25/32" hole - either that or the 3/4" hole will do.)

All valve covers which are notterne plated, should be cleaned free of rust, dirt and oil, then painted on the inside before the ventilating elbow is installed - otherwise paint will flake off and cause damage to the engine. Requisition and use 'Phosphoric Metal Conditioner' Federal Stock No. 51-A-1302 (1 gallon) Federal Stock No. 51-A-1303 (5 gallons), diluted one part cleaner to two parts water, to prepare valve covers for painting. Soak them for five to ten minutes. The solution

slowly attacks rust and dissolves grease. Remove the covers and rub with a wire brush or coarse steel wool. Soak again in solution every five to ten minutes until clean.

When clean, rinse the covers thoroughly in clean running water, then dry.

Now install the elbow and gasket on - and at right angles to - the valve cover as shown in Figure 8. The gasket will be between the elbow and the top of the valve cover, and the washer and nut will hold the elbow from underneath the cover.

Put the valve cover back on the engine.

VENTILATING VALVE AND TUBE

You'll run into two conditions when installing the ventilating valve and tube. On some '270' engines, there's a plug out near the end of the intake manifold. This is a vacuum attachment. On other '270' engines, the vacuum is drawn from a tee in the center of the intake manifold (the hydrovac brake-booster system on many of the later-model GMC's uses this tee).

In the first case, where the plug is in the manifold

out near the end, proceed as follows (using Fig. 9):

Remove the carburetor, governor and studs. Discard the studs and replace with new longer studs - the new studs should be 3-11/32" at the rear (Part No. 2103349), and 3-15/32" in front (Part No. 2137521), when installed. Discard the present spacer, insulator or whatever you're fond of calling it, that's between the governor and the intake manifold, and install the new adapter (see Fig. 9) (Part No. 2137520) over the studs, with the gasket between it and the manifold. Reinstall the carburetor and the governor.

Screw the ventilating valve (Part No. 1542867) into the adapter, turn the elbow (Part No. 137424) into the valve, and connect the tube between the elbow on the engine valve cover and the ventilating-valve elbow.

In the second case, where the hydrovac tee is located in the center of the intake manifold, you won't have to remove the governor or change the studs, just proceed as follows:

Install the vacuum line to the elbow on the top of the valve cover. At the other

end (at the carburetor), attach elbow and ventilating valve. Place the end of the ventilating valve against the hydrovac tee and prick punch the location. This will show you exactly where the valve is to be inserted in the hydrovac tee and will guarantee that the valve will be perfectly horizontal. Take the hydrovac tee out of the center of the manifold, drill a 7/16" hole at the prick-punched location and tap the hole for a 1/4-inch standard pipe thread. Clean the tee thoroughly and screw back into the manifold.

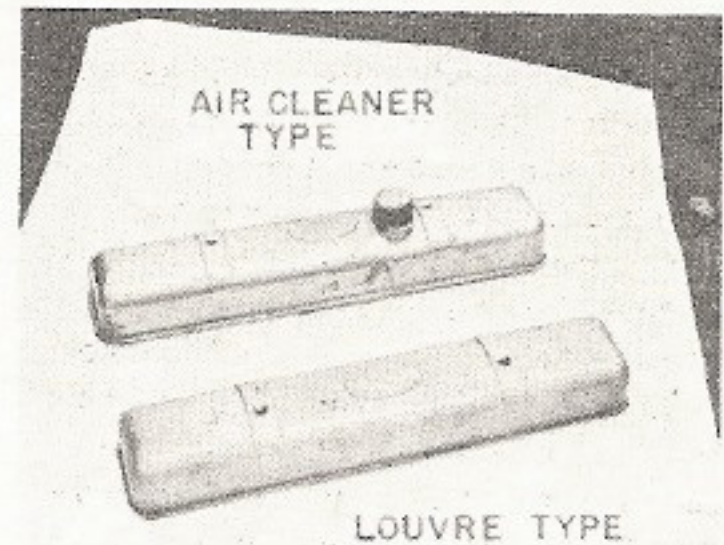

Fig. 10 - Two valve covers.

Now screw the ventilating valve into the hydrovac tee and turn the elbow into the valve. Connect the tube between the engine valve-cover elbow and the ventilating-valve elbow as shown in Fig. 9.

And that's all there is to it. Your engine is modified.

As a final check, fill the cooling system and check for leaks at all pipe connections. Start the engine, let it warm up thoroughly and check for air leaks. Adjust the idle.

Since we've been mentioning paint and painting, we might let you know that with every 25 SSL-1175 kits you order, you'll get enough paint to take care of the 25 reworked valve covers (Paint, Dupont, No. 216-51753 and Thinner, Dupont, No. 3977). Thin the paint to brushing consistency before using.

In many cases, you'll find that some of the modifications described have already been

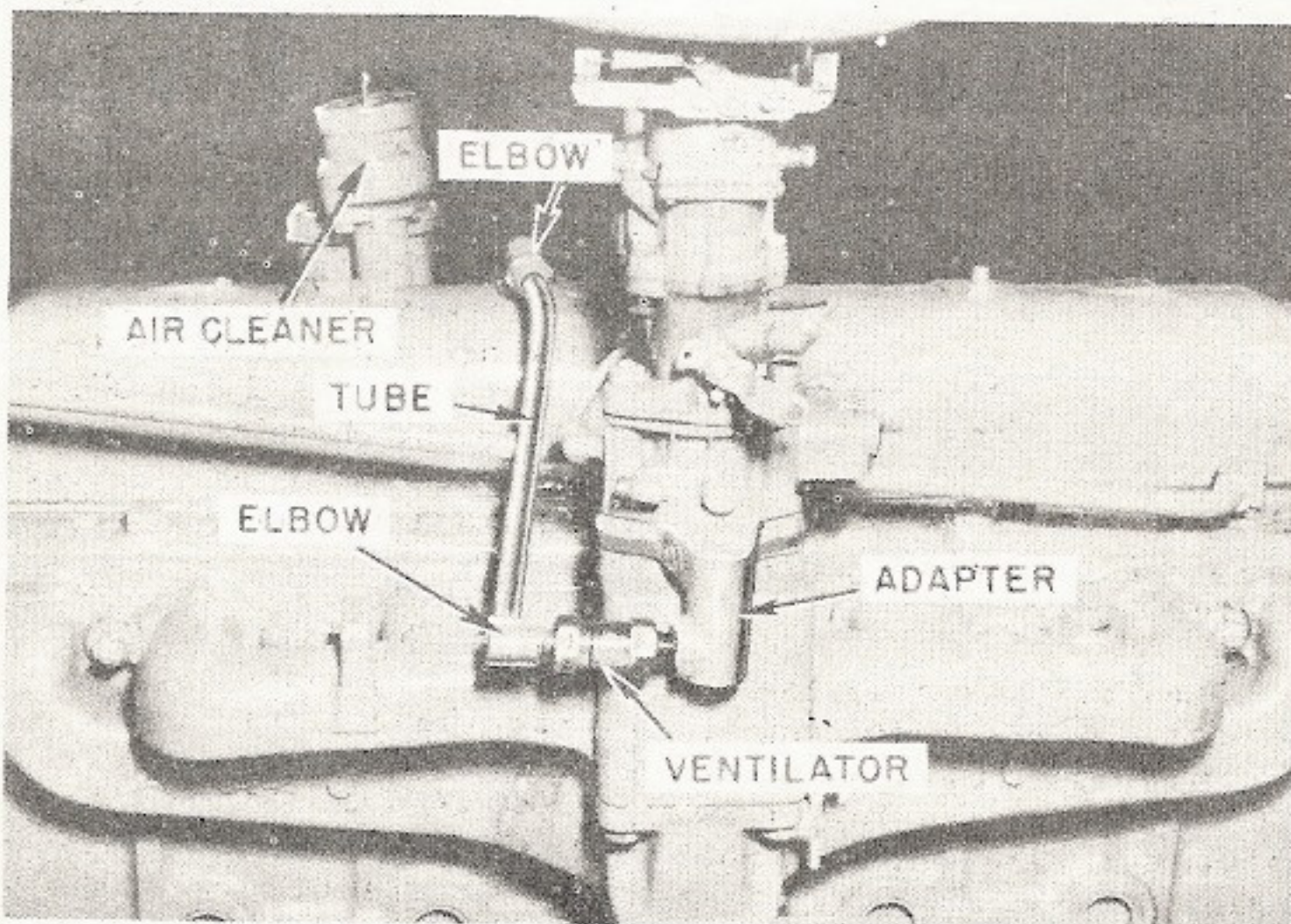
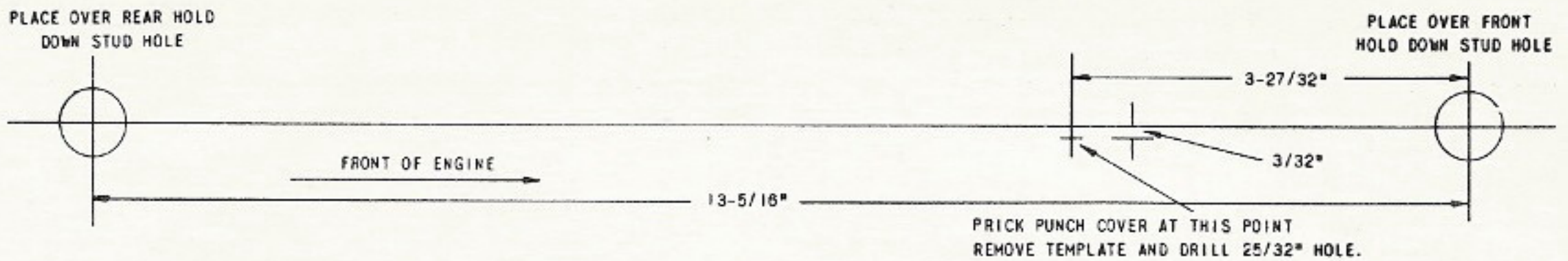

Fig. 9 - The ventilating system: air enters cleaner, emerges at valve-cover elbow and goes down tube.

FIG. 11 - TEMPLATE FOR DRILLING HOLE IN VALVE COVER



installed on some of your '270' engines - which means that you'll have parts left over. Package these parts, tag, and ship them to the Fort Wayne Ordnance Motor Supply Depot, Detroit, Mich.

Now since it's a favorite practice to blame new fixtures for any and all troubles that might crop up, we'd like to say that the new ventilating system has been thoroughly tested and found satisfactory. Even the carburetor - happy hunting ground of the half-baked mechanic - is affected so slightly by the new system that little if any adjustment will be necessary if the installations we've seen are any criterion.

A vacuum gage when hooked into the new system, reveals no reading at idling. At other throttle openings, the reading is only one inch. And speaking of vacuum readings, tests show that the system has no effect on the intake-manifold reading - thus when you take any other readings with the vacuum gage, you don't even have to consider it.

Maintenance of the new ventilating system is important. The small air cleaner must be frequently serviced; the connections have to be kept tight - any air leak will make the system inoperative. A clogged ventilator (that's about the only thing in the system with a passage small enough to get clogged) will also make the system inoperative. To uncover air leaks or clogging, take off the little air cleaner and check for air intake. Check by placing a piece of paper against the top of the filler pipe; if it's sucked flat,

(with the throttle opened at least a little) you know air is being drawn in and everything is all right.

If you find that air is not being drawn in, look for an air leak. Go over all the connections and be sure they're tight. If they are tight, and the air is still not being drawn into the tube the system may be clogged. Take off the ventilating valve and squint through the passage. If you can't see through it, it's clogged. Get a 1/16" drill and twirl it in the passage with your fingers. Finish by working the valve with a small nail poked inside. But go easy.

The ventilating valve is a diabolically clever little thing (Fig. 12) that works opposite to the manifold vacuum. When the vacuum is highest (throttle closed), the valve is closed and only an insignificant thread of air bleeds through. In other words, when the engine is idling and doesn't need anywhere near as much ventilation as when racing along, the valve cuts down the supply of air to almost nothing.



Fig. 12 - Ventilating valve (exploded).

When the vacuum is lowest (throttle open and the engine racing) the valve is wide open and permits a full flow of ventilation through the engine.

Although the ventilating valves we've seen may be taken

apart, don't be too surprised if you run across one that can't be. And, as a matter of fact, it's not altogether necessary to take the valve apart. In most cases, simply dunking it in solvent will clean it out. In cases where solvent won't work, use the 1/16" drill between your fingers as suggested before.

As we mentioned in the beginning, the installation of the new ventilating system for the GMC 270 engine is a 'red band' modification. The kits are available immediately from the Fort Wayne Depot. Order as many as you need for your vehicles.

And as fast as they're installed, educate your drivers in these maintenance points:

(1) Keep the miniature air cleaner serviced; (2) see that the choke return spring works freely and pulls the button in when it's released; (3) see that the new clamp and seal under the carburetor air cleaner is tight at all times; (4) keep all connections tight - watch out for leaks at all points in the new water-by-pass installation; and (5) watch for air leaks in the new ventilating system.

And your 2-1/2 ton GMC - middleweight champion of motor transport - will be a better truck to live with.

According to the Field Service Modification Work Order, the modifications described in this story, also include the first 13000 CCKW 2½-ton, 6x6 vehicles. These vehicles differ slightly in construction from those that came after.

More about the COMBAT WHEEL

In the dog days of August, we ran an article on handling the combat wheel, in which we stated that, at best, removing the tire was no cinch. Since then, we have received numerous letters from the field, all yowling that cinch is not the word for it.

This being the case, we sought out Mr. O. L. Tiedeman, tire instructor at the Automotive Ordnance School at Holabird. Mr. T. scoffed at the reports of trouble in demounting combat tires. Beating his hairy breast, he roared that he could remove the tire from any jeep combat wheel in 5 minutes, on the hottest summer day, without sweating.

So we picked up his challenge, and a well-rusted jeep and tramped out to the test garage.

The results are on your right: Words and pictures of the three most troublesome stages in the demounting of a combat wheel and one important step in remounting the wheel.

Mr. Tiedeman used only the following tools from the 2nd-echelon tool sets: Curved type iron, 24" long (41-I-772) in sets #1 and #2; bar jimmy, 24" long (41-B-255), in sets #1 and #2; and 3-lb. blacksmith's hammer (41-H-126) in the #2 tool set.

And Mr. T. proved he could remove the tire from any jeep combat wheel in 5 minutes on the hottest summer day without sweating.

After you've got the spoon under the rim, leave it there, and insert the jimmy 4 inches further along. BE SURE TO PRESS THE IRONS DOWN TO A NEARLY FLAT POSITION. Then, remove the spoon, and insert it 4 inches from where the jimmy is. Go completely around the tire, leapfrogging the irons. Once around the tire should loosen the bead.

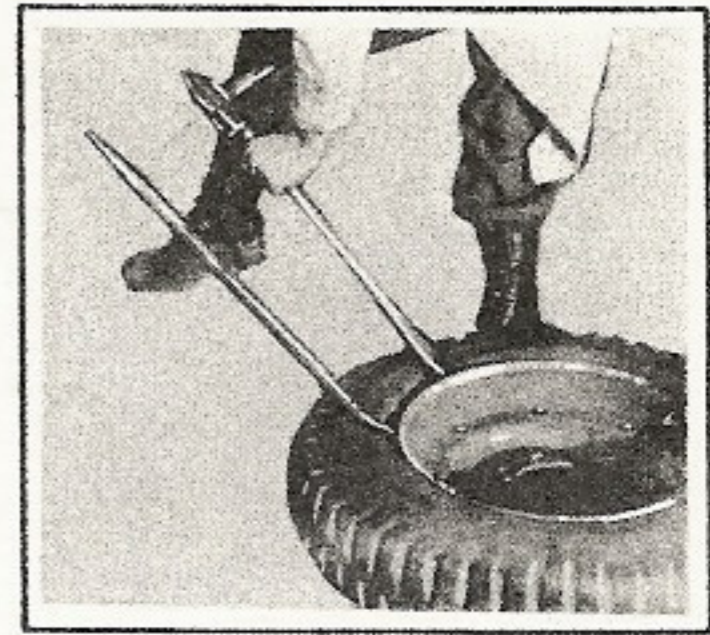

Mr. T. rockin' the rim. Having forced the tenacious bead away from the rim, Mr. T. coaxes out the inner shell with that certain tantalizin' rhythm. Next he'll turn the tire over and nonchalantly take out the other half of the rim. If you've followed the directions accompanying the photo above, you should do it as easily as Mr. T.

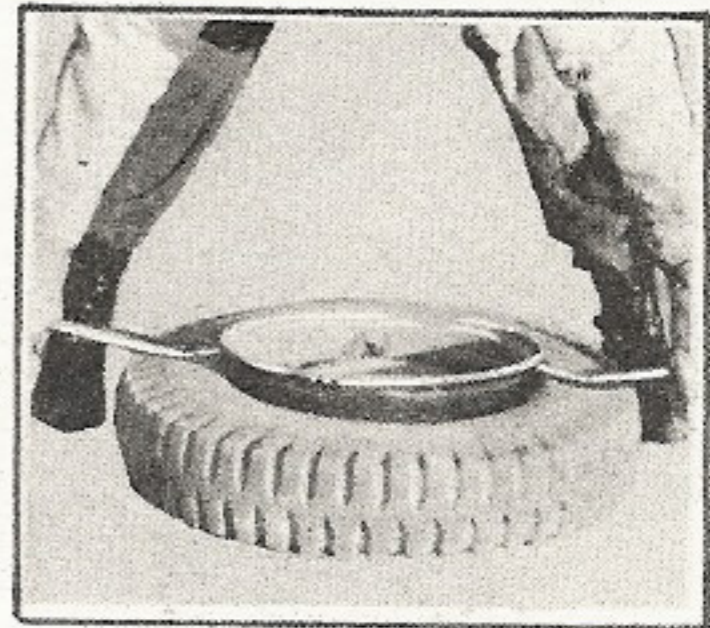

This unretouched, full-color photograph shows the good Mr. T. using his right foot to best advantage, pushing the beadlock down into the side of the tire opposite the valve. Then, with the tire on the ground, he grasps the beadlock with both hands, and standing on the tire, pulls the beadlock up, up, and away. Removing the tube is next.

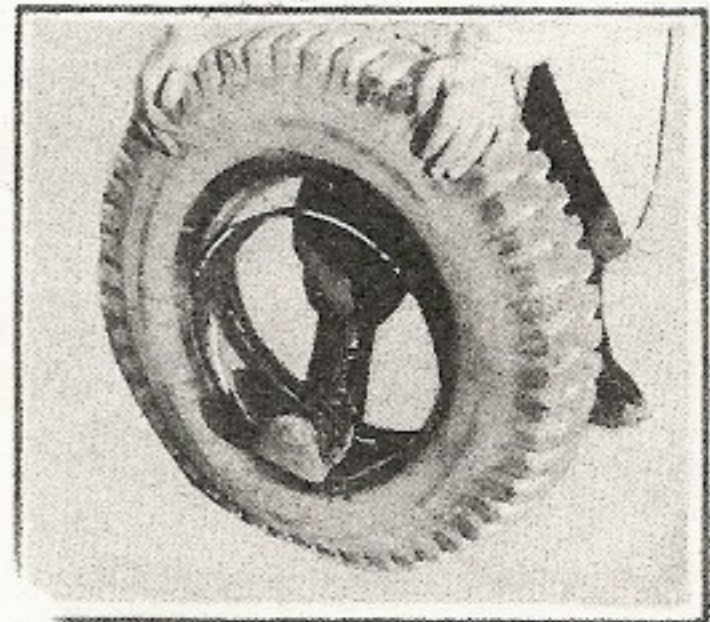

The tube has now been repaired, given some shape with a little air, and put back in the tire. The arrow indicates the hole in the beadlock through which the valve stem must go. Valve and valve hole are offset - align them properly before inserting the beadlock. Stand the tire on end, insert the beadlock at right angles, then just turn it into place.

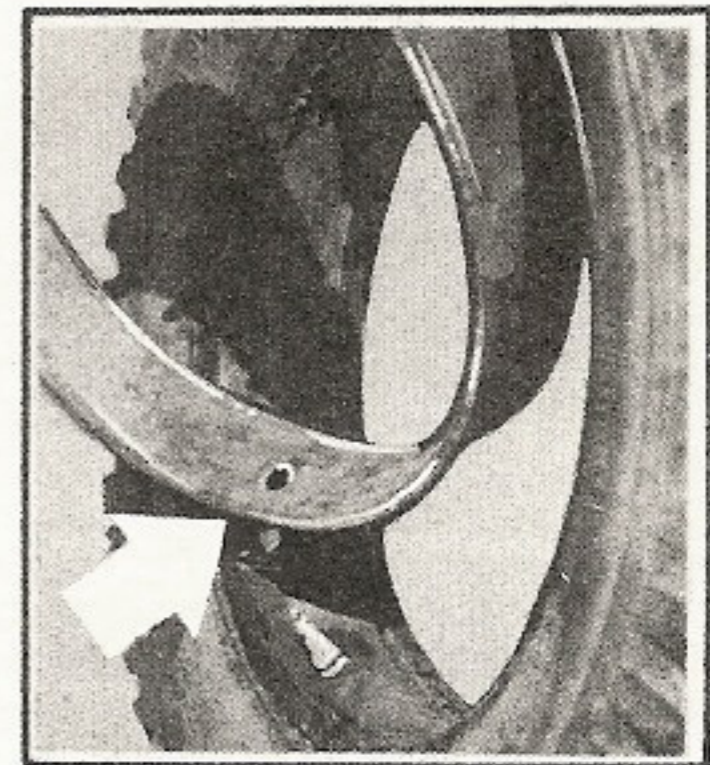

The Case of the PRAYING TRAILER

They laughed when it knelt down to pray... but they later traced the trouble to the landing gear.

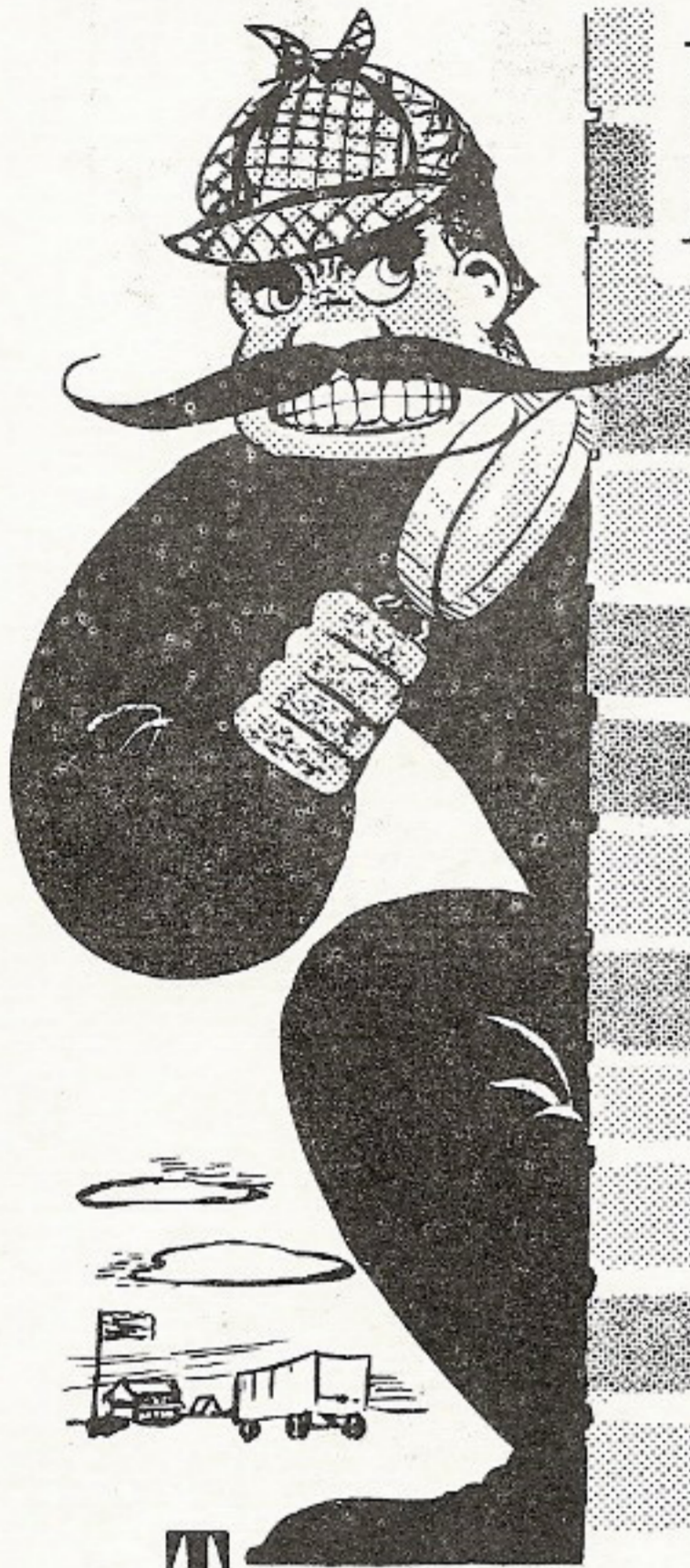

The root of the trouble is in the double bends of the backing brace; they give too easily under certain pressures. Just as any piece of pipe or flat metal is easier to bend once it has been 'started,' so the backing brace is comparatively easy to collapse because of the way the bends were put in originally.

A straight line is a perfect 'line of compression' and can take the most pressure end to end. But put a bend in it that's too far away from the line of compression and the line will buckle under much less pressure.

That's the trouble with

the landing gear on some of our heavy trailers: the bends in the backing braces are too far away from the line of compression. When the trailer is parked on a hill or gets a bump in being separated from the tractor, the braces fold up at the bends, the landing gear doubles under and lo! the trailer is kneeling in prayer.

The remedy consists of altering the braces to make them follow the line of compression more closely.

This is done by ironing out the long bends in the backing braces and replacing them with a short stiff bend

The trailer knelt down and prayed. It was a ten-ton trailer, a heavy mobile-laundry unit, but it put its nose down and its fanny up and made an obeisance upon the ground.

To Lieut. A. W. Soskins, Co. A, 65th Bn., Laundry, Camp Pickett, Virginia, a praying trailer is nothing new. He says it's no unusual sight to see one of his heavy, mobile-laundry units gently bend its knees and sink piously to the ground.

This sudden religious fervor among trailers is due to weak backing braces at the landing gear, a condition which has been discovered on many of our heavy trailers.

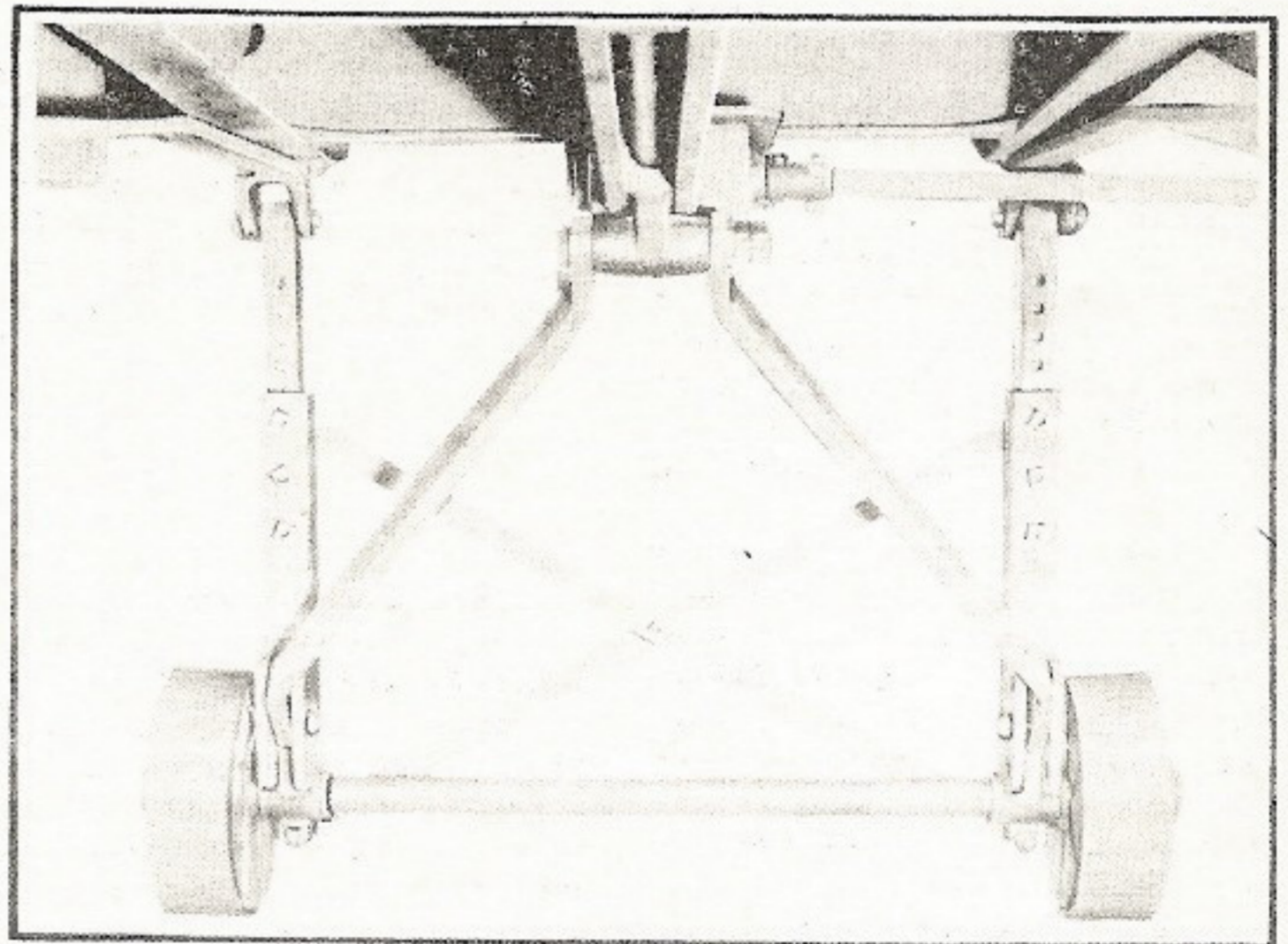

Fig. 1 - This is the way the back braces of the trailer landing gear will look after you have altered the bends to prevent the trailer from kneeling in prayer.

at each end of both braces (Fig. 1). (The bends are there in the first place, to allow the landing gear to fold up when not in use.)

If you have a 60-ton press handy, you can push the old bends out and press the new bends in cold on a plate laid across the press cross pieces. Without a press you should be able to blacksmith the job. An anvil, a sledge, a forge and a chestnut tree for atmosphere should suffice. Bang the old bends out, turn the ends as shown in Figure 2, and paint.

The ten-ton mobile-laundry unit has a Dayton landing gear under a 34-inch trailer frame. If you've got to do the job on a trailer of different dimensions, you may have to vary the fix a little.

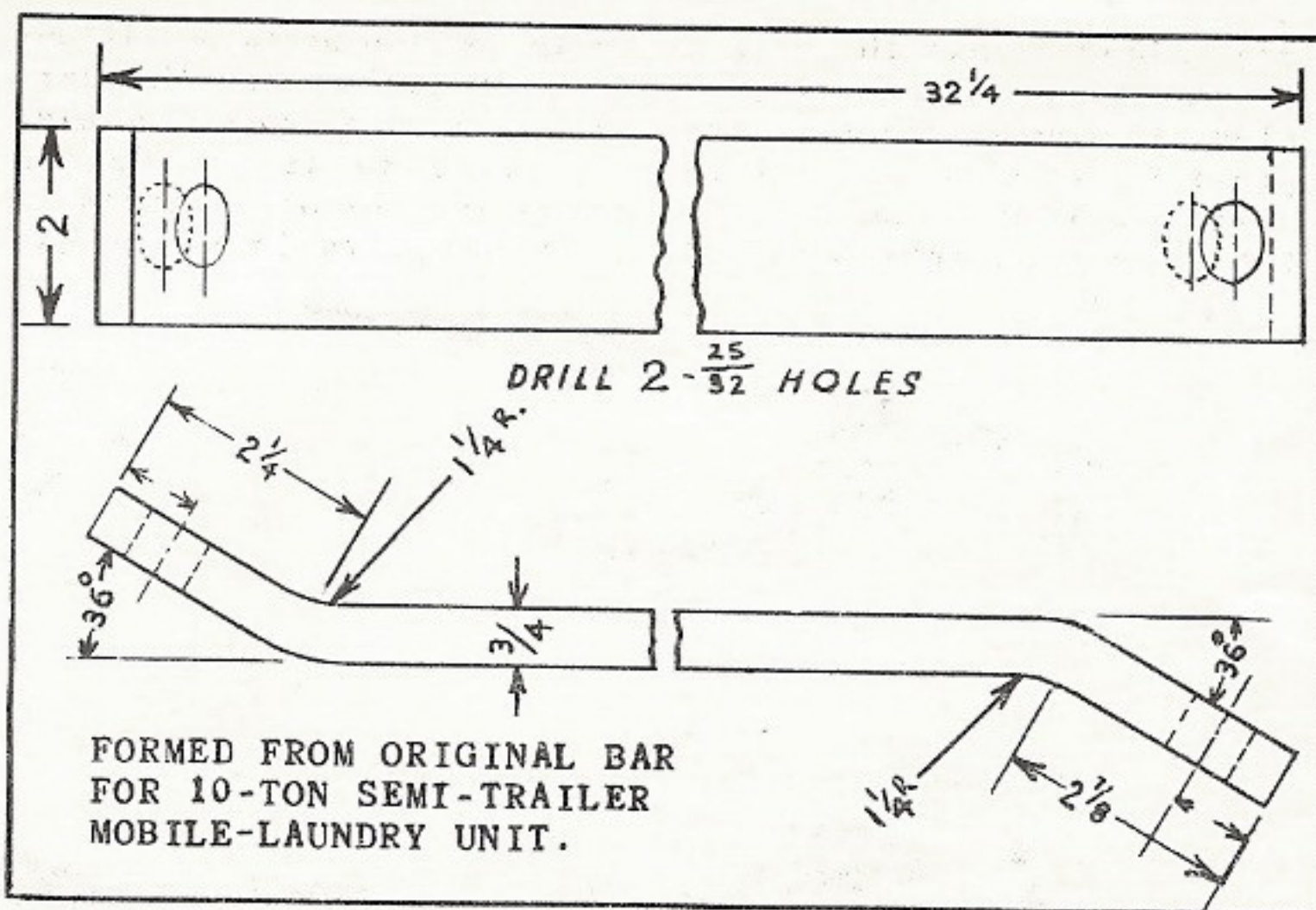

Fig. 2 - This whiteprint will help you make the fix.

Little Giant



60-TON-PRESS PLATE

Protect your press and double its usefulness with this easily made plate.

Standing idly by the other day watching a guy cracking paper-shell pecans with a 60-ton press, the thought occurred that here was a toy you could really go to town with. The 60-ton press - it can handle more things than a lady's corset.

But some people are never satisfied. L. W. Alfred, for instance. Alfred is a restless chassis specialist working out of Maintenance Engineering, Detroit. Before the war, he was busy inventing little devices to make frame and axle straightening a pleasure.

Standing reflectively in front of a Manley 60-ton press, a couple of weeks ago, Alfred began to dream. When Alfred begins to dream, his cigar starts wandering slowly around

his face, as the idea grows hotter, the cigar goes faster.

Then suddenly Alfred and cigar were upstairs putting the dream on paper.

The idea - let's call it 'Alfred's dream' - is a plate (Fig. 1) to fit down on and protect the cross channels of the press so they won't be bent when long parts are being straightened. Presenting a sizeable flat surface to work on, the plate allows easy handling of parts of all sizes. It's ideal for straightening bumpers, trailer tail gates, trailer tongues, wheels, and serves beautifully as a work plate for various press jigs.

It's heavy too. It's made of a chunk of one-inch boiler plate - or rather mild steel -

18 by 30 with all kinds and sizes of welded supports under it (Figs. 2 and 3).

Alfred built it this way: He laid the plate upside down, placed three webs of 1/2-inch material, three inches wide, longways along the bottom of the plate and arc welded them to it (Figs. 3 and 4). He set the two outer webs in about 1-1/2 inches from either side and the third web right in the middle between them.

To make the arrangement more pleasing to the eye and easier to handle, he whacked off the lower corners of each web.

Four tie bars are welded between - and flush - to the bottom of the webs. These are located so that they sit on the inner edge of each channel of the press to distribute the pressure along the strongest part of the cross channels. They are spaced 9-1/2 inches apart and are about 10 inches in from each end. Says Alfred, if you intend to make this plate for any other press, set these tie bars in accordingly.

To keep the plate from leaping lightly from the press and wiping off your knee caps, two more bars - 5/8 by 1 by 15 -

are welded across the bottom of the webs, spaced to just clear the outer edges of the press cross channels. They serve as stops and prevent the heavy plate from slipping.

On the 60-ton press, a fifteen-inch space between the bars will clear the cross channels. As good as the 60-ton press is, the plate gives it a versatility it never had

before. As Citizen Alfred says, carefully wiping the top of the bottle, "You might be able to invent something as good but you'll have to go some to invent something as heavy."

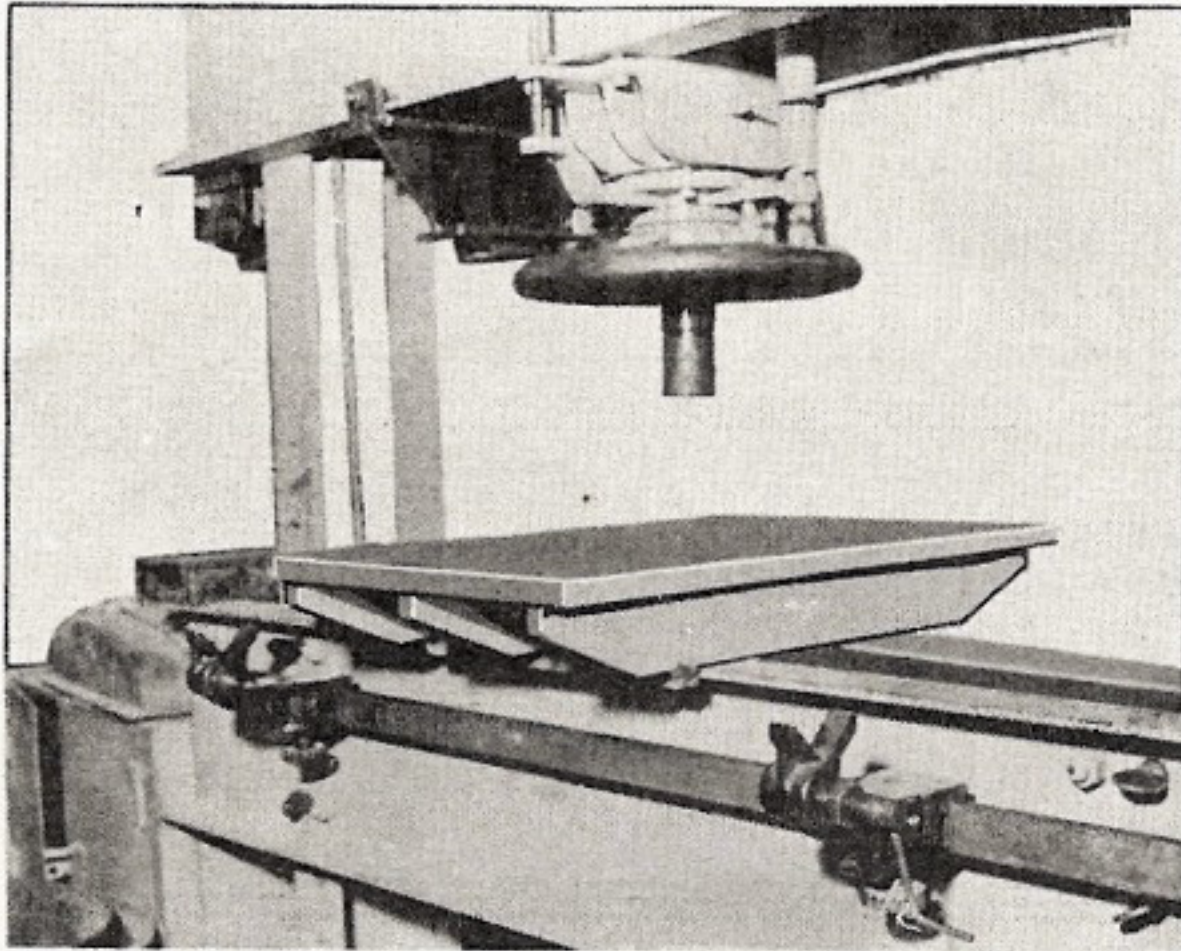

Fig. 1 - The plate protects the cross channels of the press and gives a good surface for working with small pieces.

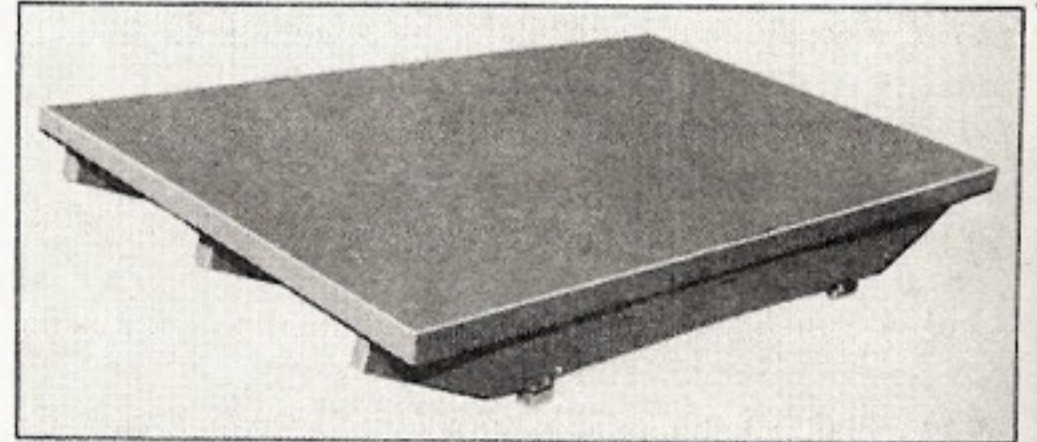

Fig. 2 - 'Up' view of the plate. The 'table' top is of one-inch mild steel.

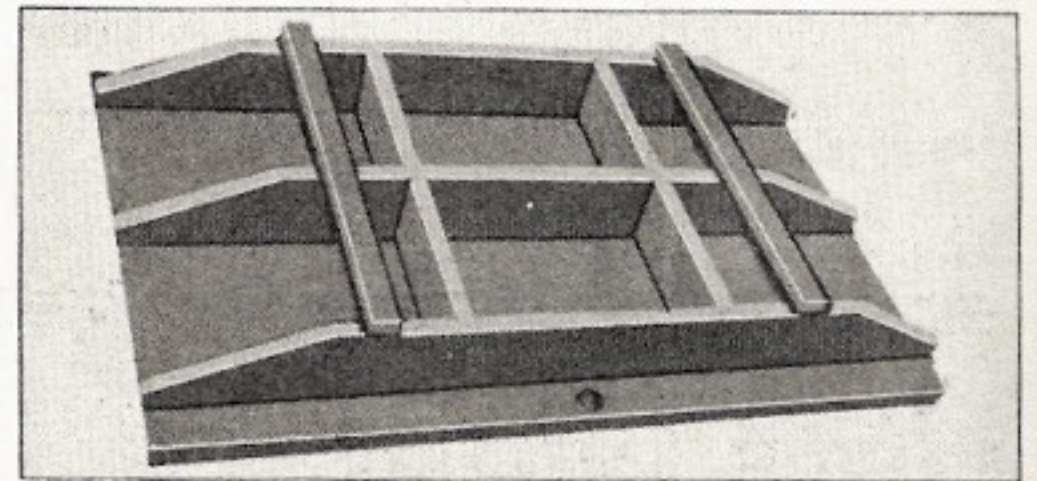

Fig. 3 - Bottom view. The webs are the understructure; the two bars are 'stops.'

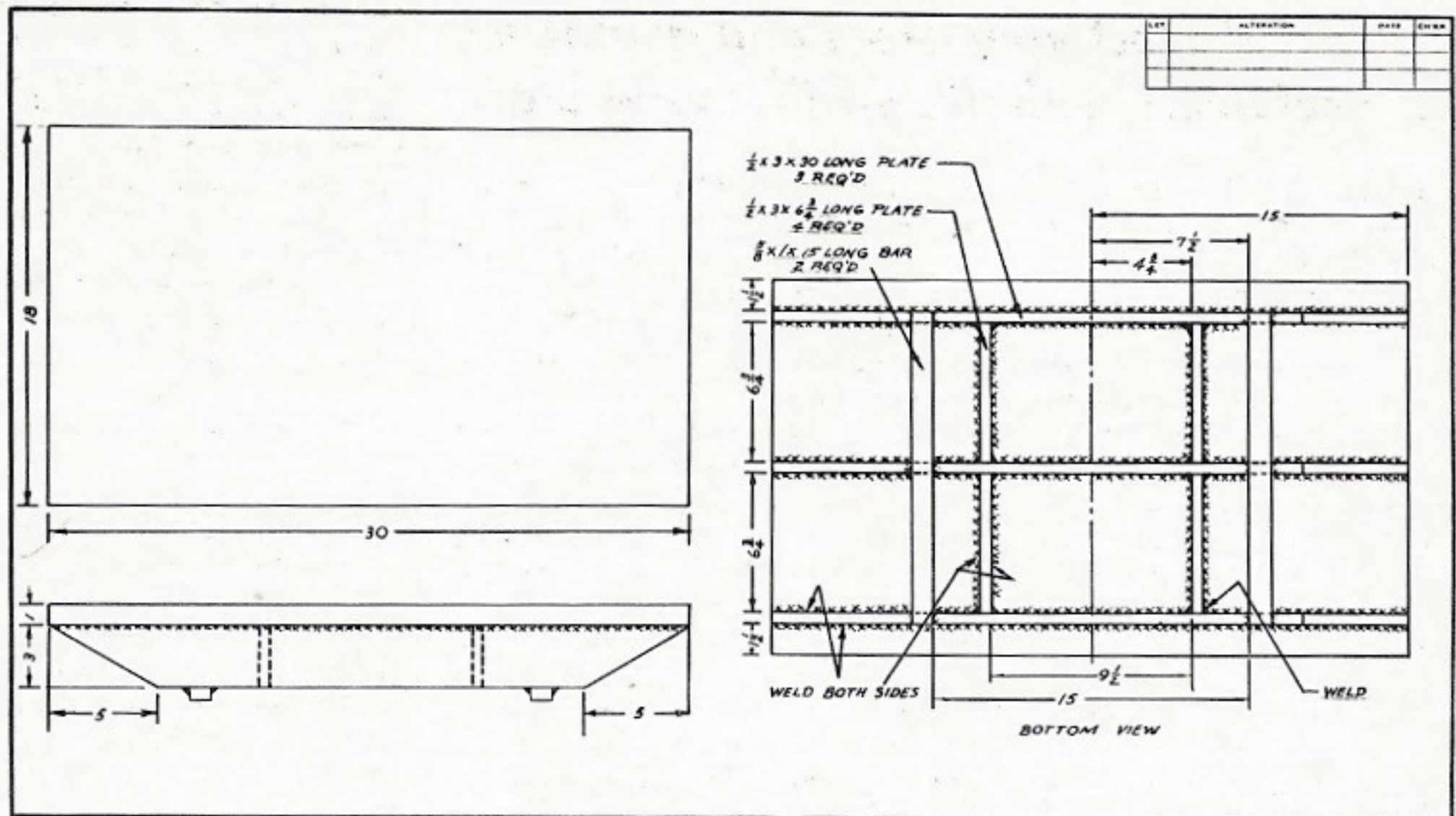
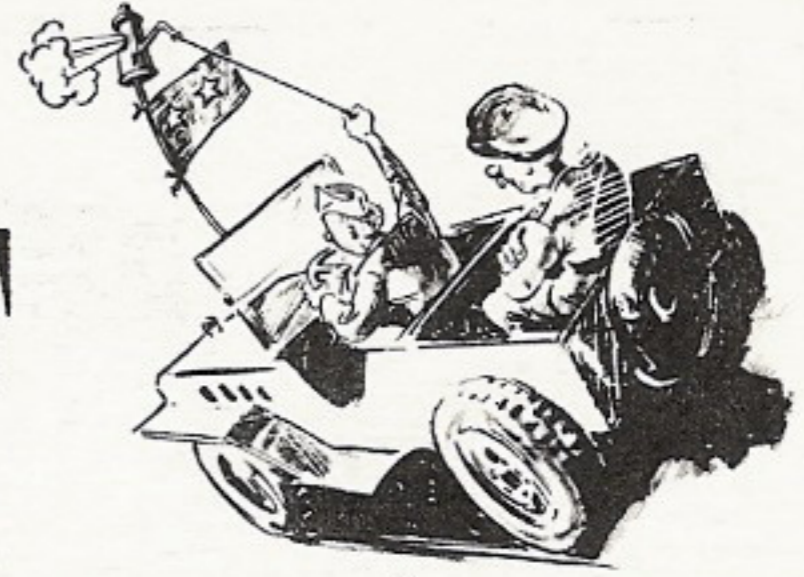

Fig. 4 - Plans and specifications for the little-giant pressure plate.

General Officers' FLAGSTAFF



One day soon, if you're in a 2nd echelon or higher unit, you may be confronted by a general officer with the request that you install a flagstaff on a vehicle that has just been assigned to him.

Being an ambitious sort, you immediately hop to the task full of verve, dash and ignorance, and construct a flagstaff replete with eagles, gargoyles and generally resembling a totem pole.

Shortly afterwards the general, viewing your handiwork, which you have thoughtfully mounted in the radiator

The general may want one any day now. Here's how to build and where to mount it on the general's vehicle.

filler neck, takes off on a short flight of apoplexy, at the conclusion of which you find yourself designated high man on the trash wagon.

For a flagstaff, although it may sound like a little bit of nothing to you, is important enough to rate a lot of space in Army Regulations and must be built according to Hoyle. Specifically, AR 260-10, Change

5, October 14, 1942, Paragraph 2 g. (5) (b) and (c) says staffs for general officers will be metal... of sufficient length so that when mounted as indicated in (c) below, the lower edge of the flag will fly about 1 inch higher than the crest of the hood of the automobile.

"(c) Staffs for automobile flags of general officers will

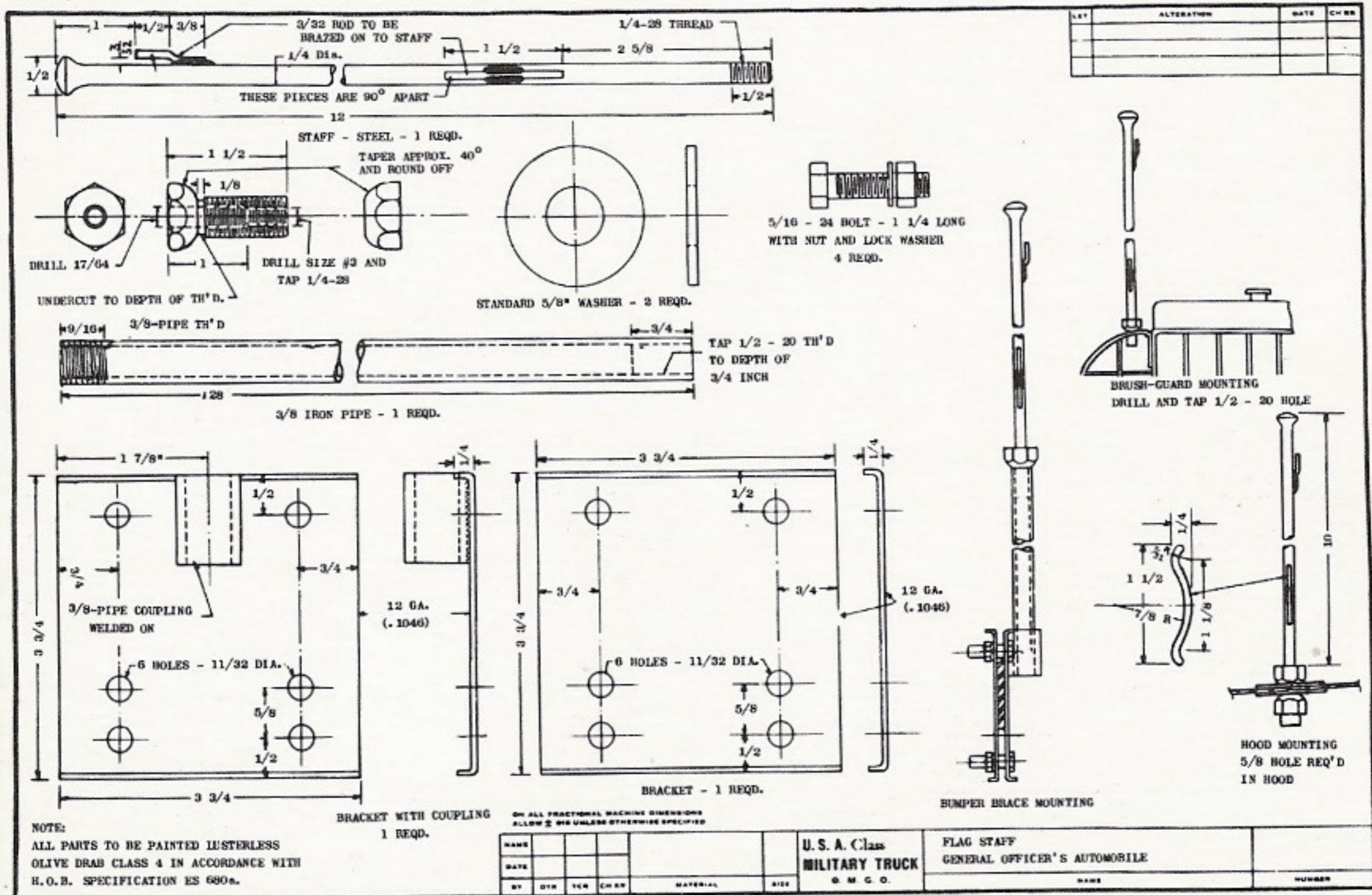

Fig. 1 - Whiteprint showing construction details of the general officers' flagstaff.

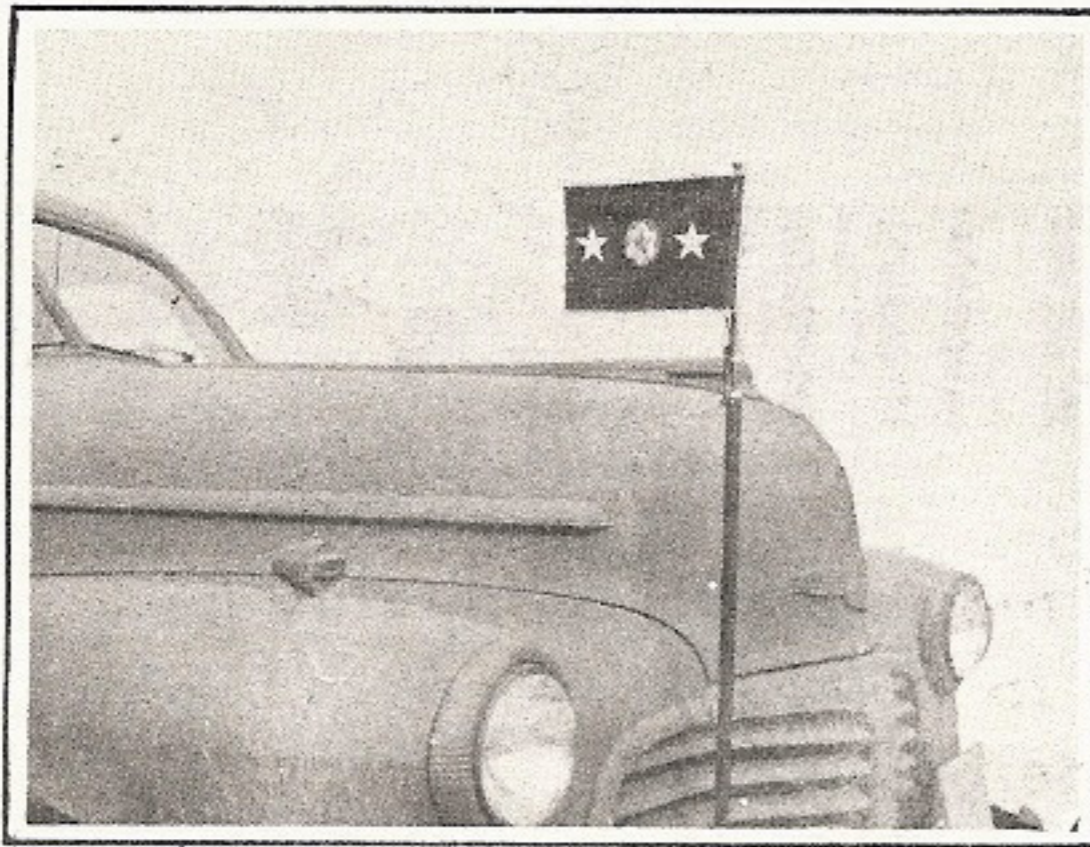

Fig. 2 - On passenger cars the flagstaff is mounted on the bumper bracket.

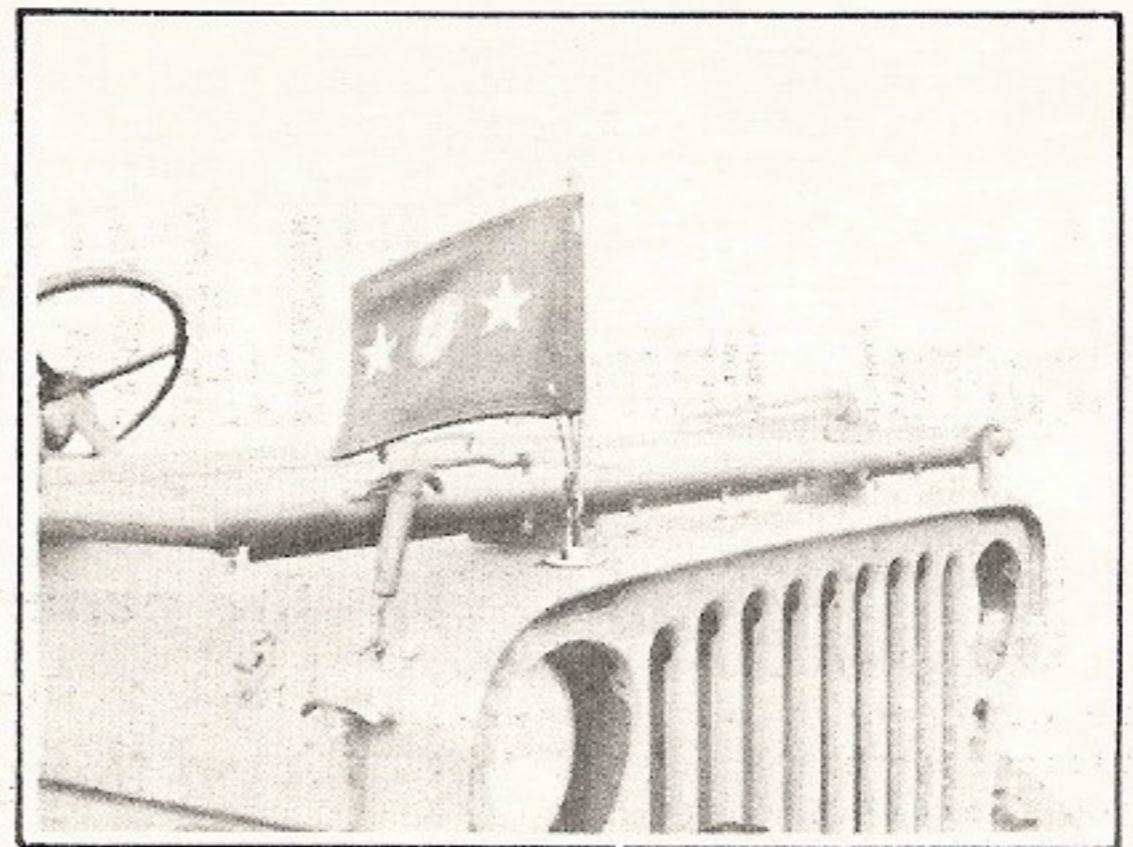

Fig. 3 - 1/4-ton jeep with flagstaff mounted on the hood.

normally be mounted on the right front-bumper support. Where this is not practicable the nearest suitable location which will not interfere with the right headlight beam will be used."

For this reason, a bulletin is being prepared on how to build and mount a flagstaff for general officers' flags.

According to the bulletin, the staff (the part where the flag is attached) can be readily made from a GMC valve push rod, Part No. 2135423, by annealing the rod where it is to be cut off and threaded (see print, Fig. 1). (To anneal the rod all you have to do is heat it to a cherry

red where it is to be cut off and threaded, and allow it to cool slowly.)

Cleats, made from 3/32 steel welding rod, are then brazed onto the push rod. The flag will be attached to these cleats: The top cleat pushes through the material; a silken cord from the flag is tied around the bottom cleat.

The little push-rod flagstaff sits down in a socket. This socket (see print) can be made from a Plymouth wheel bolt, Part No. 393984, or any standard 1/2-20 bolt.

On passenger vehicles, the flagstaff is mounted on the bumper bracket (Figure 2). To accomplish this, a 28-inch

piece of 3/8-inch iron pipe is mounted on the right bumper bracket by means of the plate shown in the print. The flagstaff socket screws into the top of the iron pipe.

On vehicles other than passenger vehicles like the jeep, command car, carryall etc., the mounting is somewhat different. Instead of being mounted on the bumper bracket, the flagstaff is mounted on hood or on the right headlamp guard (Figs. 3 to 7). For this, a hole must be drilled in the hood or in the headlamp guard. On the hood, a washer is fitted onto the flagstaff socket, the socket goes down into the hole and is held from

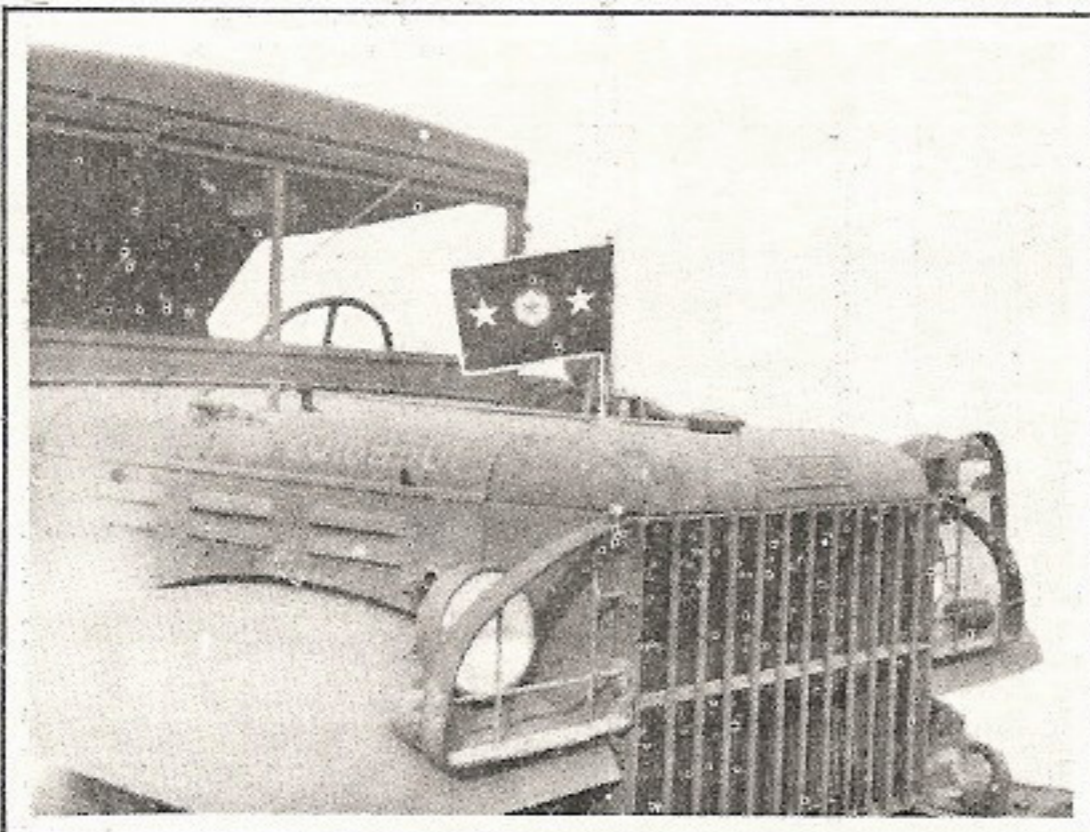

Fig. 4 - 3/4-ton Dodge with the flagstaff mounted on the hood.

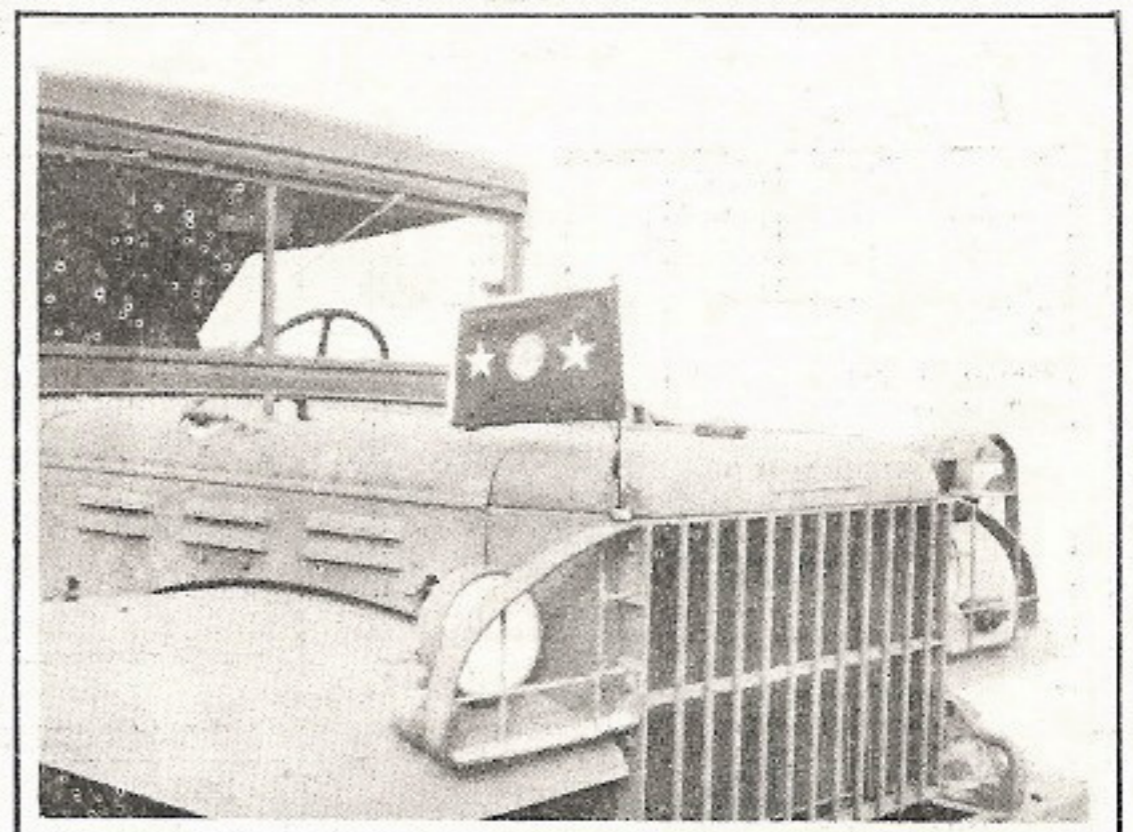

Fig. 5 - 3/4-ton Dodge with the flagstaff mounted on the headlamp guard.

underneath by a taper-faced nut and another washer (see print again). The taper-faced nut can be made from a 1/4-ton, 4x4 wheel stud nut or any standard 1/2-20 bolt. For mounting on the headlamp

guard, simply drill and tap a 1/2-20 hole and screw the flagstaff socket down into it.

As mentioned above, the flagstaff may be manufactured and installed by any 2nd echelon or higher unit, and

although it may not improve the performance of the vehicles it's placed on, the general officer may think it's important. So tuck our directions away where you can find them.

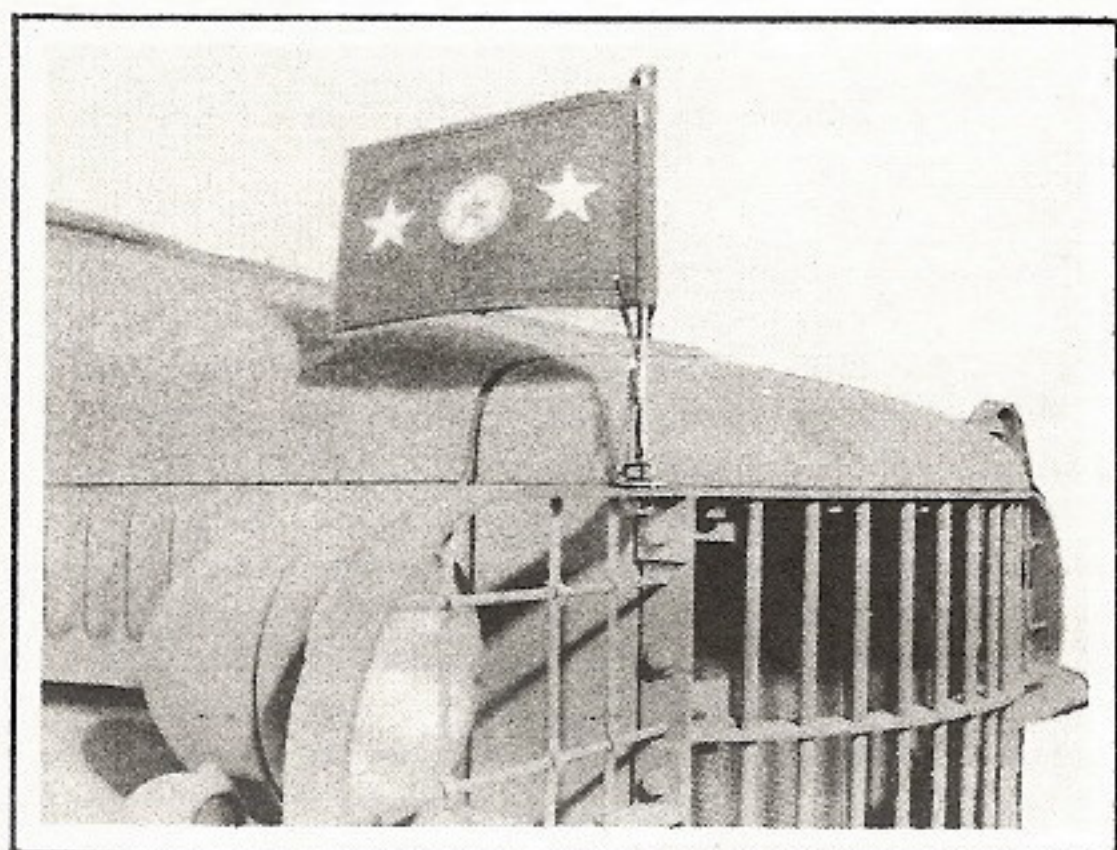

Fig. 6 - 1/2-ton Dodge with the flagstaff mounted on the headlamp guard.

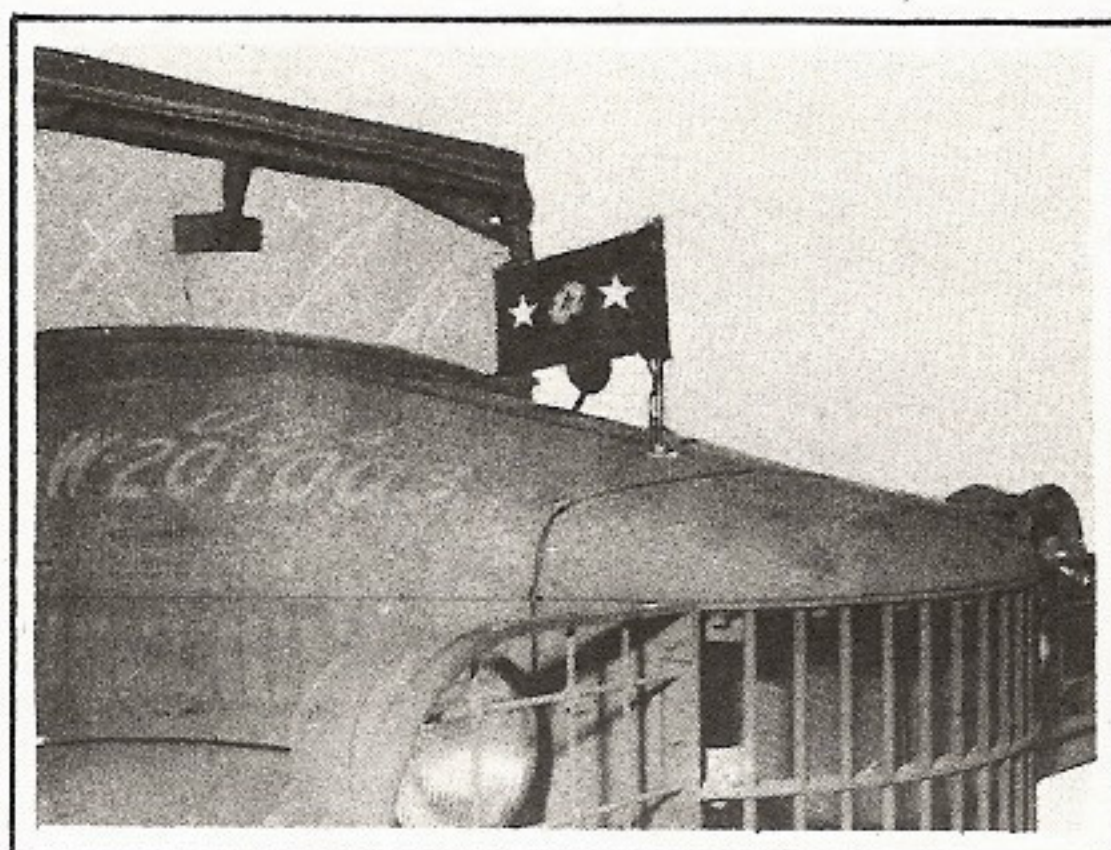

Fig. 7 - 1/2-ton Dodge with the flagstaff mounted on the hood.

How Tight Is Tight?

The 1st and 2nd echelon is charged with keeping bolts tight. This includes body bolts; cylinder head bolts; engine mounting bolts; manifold and carburetor nuts and bolts; clutch, transmission, and primary-chain-cover nuts and capscrews.

But how tight is tight?

In a good many cases, the maintenance manuals carry torque specifications stating exactly how tight a given nut or bolt should be. For instance, the manual will always specify the proper torque to be applied to cylinder-head bolts and the exact pattern to be followed in tightening the bolts.

But in many other cases, tightness is left to "feel". The driver or mechanic is supposed to use the sense of touch in his good right arm. If the sense of touch is so highly developed by training and experience that the nerve ends quiver with joy at the mere approach of a wrench, all is well and good. But if all that a man has in his arm (and head) is muscles, then look out!

Brute strength or the Lionel Strongfort method of tightening bolts will, paradoxically enough, lead not to tightness - but to looseness. Put blind, brute force on a bolt and you'll strip the

threads. A bolt with stripped threads will no more hold than a busted girdle, and the part it's supposed to be holding will tinkle loosely in the wind. Not only that, but careless or ignorant tightening may twist off a bolt deep inside an assembly, giving the unfortunate mechanic one holy time getting it out.

Just recently we got a report that the bolts of the spring rebound clips are being tightened too much. The bolt threads fail and the clips won't hold. This allows the spring leaves to shift or even break. Weak, broken or shifted spring leaves lead to all kinds of trouble: the axle may shift completely out of line or the steering mechanism may lock, taking steering control completely out of the hands of the driver.

Another item: the axle-flange bolts of the GMC are supposed to get only 35 to 40 pounds of torque. They are capscrews and won't take much more than that before breaking off. Furthermore, they won't

break off at the cap - they break off deep inside where it's torture to get them out. The same goes for the axle-flange capscrews of other makes and models of vehicle. Technical Service Bulletin E-12 for instance, specified 95 to 119 pounds of torque for Chevy axle-flange capscrews. (Searching the Ford and Willys 1/4-ton jeep manuals for axle-flange capscrew torque specifications we find none. We'll try to get them for you later.)

Follow the torque specs whenever they're available for tightening capscrews.

How tight should you draw down the wing nut on the top of the carburetor air cleaner? A recent "Victorygram" put out by the AC Sparkplug Division of General Motors, says, *Using your fingers, tighten only enough to hold the cover securely in position. Don't use pliers--you'll warp the cover, and allow air to sneak in under the cover and directly down into the throat of the carburetor, bypassing the cleansing oil bath or element.*

Not long ago, GMC put out a service bulletin calling attention to the necessity of keeping the cab mounting bolts tight. The bulletin warned that loose mounting bolts would cause the cab to shift, with steering column breakage quick to follow.

But here's a funny thing: a man may tighten the cab mounting bolts with doglike devotion and still they seem to be forever loose. The reason for this is peculiar. As the truck rides along, the cab gently bounces and vibrates; the bolts, subjected to alternate stress ("hysteresis") grow and elongate. The bolts stretch a little, and then they stretch some more. The driver comes along, swears black and blue that he tightened the bolts just last week, and here they are loose again. This sort of horseplay may go on until bolts that were originally three inches long, have stretched to six inches. (Believe it or not.)

There's not much you can do about stretched bolts except keep tightening them. That's the best advice anybody can give you: keep tightening them.

How many "overhead-valve" engines have you seen with oil leaking out from under the back of the valve cover? The gasket may be new and fresh but still the oil dribbles out like it was free.

Blame it on ignorant tightening. If the hold-down nuts are over-tightened, the valve cover gets distorted or sprung, leaving plenty of room for the oil to leak out.

Proper tightening of valve-cover-hold-down nuts depends on "feel" Tighten the nuts down as far as you can with your fingers, then - and here's a little trick - press the valve cover down with your other hand. Using your fingers again, give the nut one more full turn. When

you release the valve cover, it'll have the proper tightness. Or if you've got a good sense of touch, screw the nut down with your fingers, then with a wrench, tighten it until you feel it crushing the gasket - *and no more.*

But don't tighten the nuts until the valve cover doubles up in pain and lets the oil leak out.

Nuts and bolts - big bolts, little bolts, thick bolts and skinny bolts - as far as the eye can see, all over the vehicle. Each one poses the question, how tight is tight? Sometimes the answer is in the maintenance manual, most times it's in the hairy right arm of the driver or mechanic.

The wise motor sergeant will begin immediately to do himself and his boys a favor by schooling the good right arms in his organization in the delicate art of 'feel'.



DANGEROUS AIR

There's a certain little toy in your shop that's turned out to be a snake-in-the-grass.

It's the air gun: so convenient and soul-satisfying to use, that it's often employed on jobs where it's quick acting poison.

We'll never forget one memorable morning when at each of three different shops, three laggards in the human race showed us how easy it is to clean the element of the gasoline filter with an air gun. The filter element, as you know, consists of many paper-thin brass discs arranged in a close-fitting stack a couple inches high. Well, these three stalwarts, with the blind confidence that usually accompanies stoney ignorance, snatched up an air gun and applied a mighty blast to the outside of the delicate

element. What happened?

A blunt instrument couldn't have wreaked more havoc. The leaves crumpled and curled and were ruined forever.

The intelligent method is to swish the element around in solvent and then if you must use the air gun to blow out stubborn dirt, shoot the air stream down through the center channel of the element (with the element nut held over one end to allow a slight pressure to build up).

But with the air stream shot at the element from the outside in, a piece of expensive equipment dies a quick and unnatural death.

Carburetor (and other) air-cleaner elements are a favorite target of blow-gun fiends. Holding the copper-wool element in one hand, they blast away with the air gun in

(Continued on page 316)



Contributions

Got a good idea? Invented something lately? Got a gripe? Shoot it along to us. Maybe you've solved a problem everybody else is worrying about. Pass it to us, and we'll buck it to the rest of the boys in the field. You'll get a personal subscription if we like your idea - you lucky thing.

Last month when we gave you Sgt. Fortin's method of lapping wheel cylinders, we forgot to tell you to be sure you get all the valve compound out of the cylinders.

Was it necessary to tell you or did you know that even a fine amount of grit in a wheel cylinder will put you up a tree one day?

Hundreds of hub caps on 1/4-ton Ford and Willys jeeps have been ruined by heavy-handed men with screwdrivers and wrenches, trying to separate the hub-cap from the axle. Things stayed in this sorry state until last week, when into our office popped Master

Sergeant N. Potter of the Ordnance Automotive School Detachment of Holabird, with a neat hub-cap puller-offer. It does away with screwdriver prying and wrench twisting. The puller was made from salvage scrap. In Figure 1, you see the hooks neatly tucked under the flange of the cap, gently lifting the cap off the axle base. A few easy turns on the handle, and presto, the job is done.

Although this tool may strike you as a big hunk of iron for a small job, it has proved pretty valuable in one 'vehicle preparation' center where many jeep hub-caps have to be pulled.

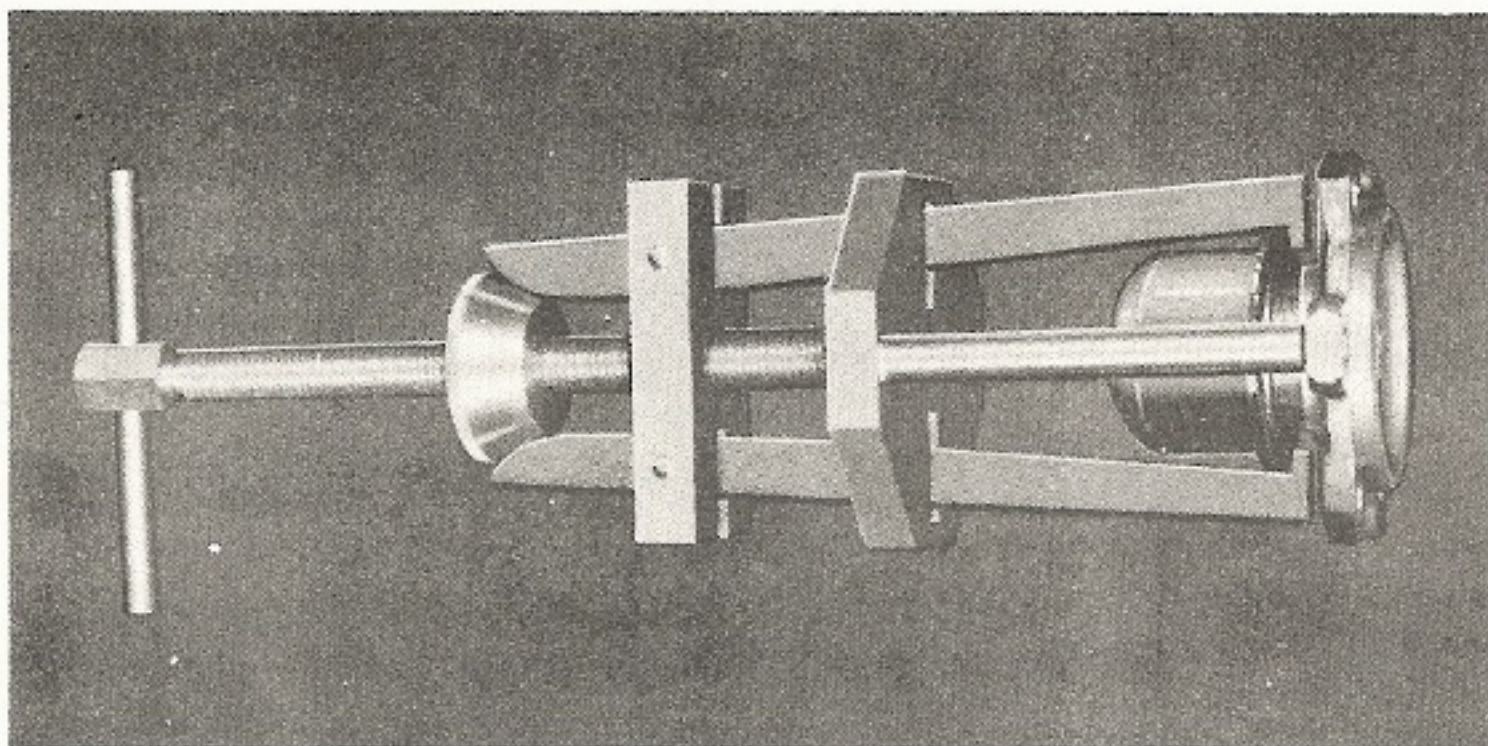

Fig. 1 - Action photograph of the nifty hub-cap puller-offer for 1/4-ton Ford and Willys jeeps.

Dear Ed,

Here's a bit of a suggestion on the new Blackout Driving Light: On the lights furnished in Kits No. 2, 3, and 5, the bracket curls up in such a way that it's impossible to reach the lens retainer rim screw with a common screwdriver without removing the light from its base. Removing the light from its base, of course, requires readjustment of same.

We eliminated the trouble by drilling a 5/8" hole in the bracket in line with the retainer rim screw. This allows you to poke a screwdriver through the hole and reach the screw without trouble.

I think the best idea would be for the factory to drill the 5/8" hole since 2nd-echelon outfits who might have to install the Blackout Lights, are sometimes without powered drills of the 5/8" size.

T/Sgt. P.M. Rawlins
1st QM Bn.
QM School, Camp Lee, Va.

Dear Editor,

I have a suggestion on a convoy maneuver, and I think you'd like to know about it.

In the past years I have always reversed directions of the convoy in a manner which I'm unable to find in

any of the manuals. I have used this method since being at this post on several occasions and have found it very satisfactory.

The object of the movement is to keep the convoy in the same formation after turning around. In other words, the first truck in the column will still be the first after the column has 'to the rear' marched. As a general rule the Convoy Commander has arranged his trucks with the slowest trucks in the lead and the maintenance section and ambulance bringing up the rear. This maneuver will retain the original order.

Above sketch may make the maneuver easier to understand.

Lt. Shelton C. Till, Jr., 128th Ordnance Motor Supply & Evacuation Regiment, Pine Camp, New York.

Although he didn't tell us how he happened to discover this ingenious bit of interchangeability, M/Sgt. Elvin P. Childress, 3414th Ordnance MM Company, Camp Adair, Oregon, says that Dodge oil seal No. 599086 can be used in a pinch to replace Diamond T oil seal No. BB 1219. His process follows:

"If you've got a Diamond T on the deadline for lack of a water-pump-driveshaft oil seal at the timing-gear housing, take the defective seal out (very careful now, you're going to use it again), and put it on a lathe with the chuck gripping the outer rim, and the flare facing the head stock. Trim the smooth side of the seal until the back is cut completely off - remove the leather and the spring - and press in Dodge seal No. 599086.

After a good half-hour bath in Neatfoot's oil or light engine oil, your makeshift seal is ready to be pressed into the Diamond T timing-gear housing, and if properly machined and installed will last as long and do its job as well as the part originally intended to be used. (The clearance of the homemade seal is exactly as called for in the Diamond T manual.)

Dear Editor,

Last November, Sgt. Warner gave us the cure for that mysterious knock in six-cylinder Fords. Here's the easiest way to determine whether such a knock is caused by a loose "impulse neutralizer" or floating dampener, as he calls it, on any type of car in which a unit of this type is a part of the standard

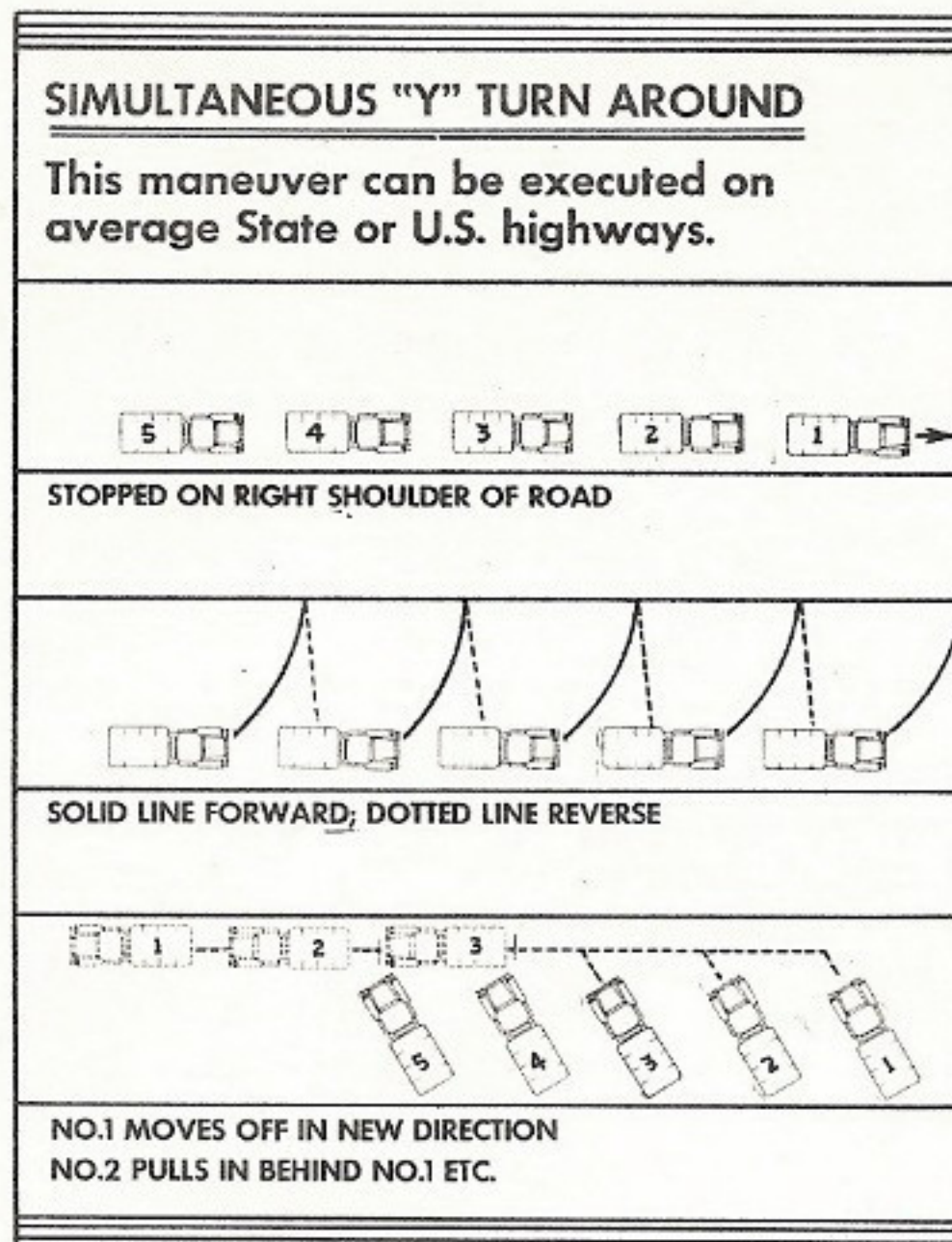

equipment. Merely ground one of the spark plugs while the engine is at idling speed.

The grounding of the plug will naturally make the engine run uneven, with the resulting oscillation of the impulse neutralizer and therefore very quickly lead you to the cause of the knock.

S/Sgt. Jos. F. Bobalik
Hq EDC & First Army G-4
Governors Island, N. Y.

Cpl. Paul A. Stromberg is battalion welder for the 635th Tank Destroyer Battalion. He noticed that a great number of oil seals were being mauled into place with chisels and punches, and were taking an awful beating. So he took himself a handful of scrap iron and went to work with his welding torch. The result was the oil-seal inserter in this picture.

Now, he says the guys in the shop can beat hell out of the inserter, but they can't hurt the oil seals. His only complaint is that it looks like he got himself a lifetime job making these inserters for all the companies in the division. And he doesn't want a lifetime job.

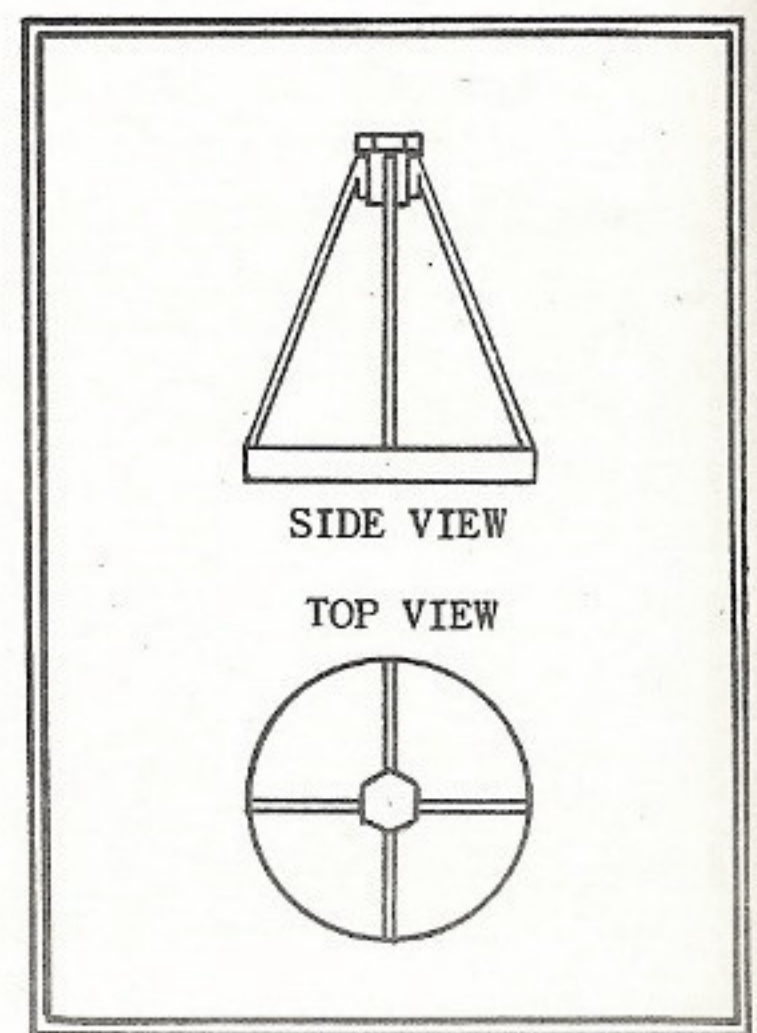

Oil-seal inserter from salvage.

This sketch, which Sgt. Fortin says is not to scale, is an efficient, home-made toe-in gage that can be whipped together in any second-echelon shop.

Here's its use as the Sgt. describes it:

In use the toe-in gage is put on the wheels with the chains just touching the ground, then the zero on the sliding gage is moved to the pointer. Roll the truck forward again until the chains are just touching the ground. The distance that the pointer

moves away from zero is the amount of toe-in.

The divisions on the sliding gage are 1/8 inch apart. A set screw may be used to keep the gage in place.

If a large-diameter retracting spring cannot be found, then three throttle-return springs hooked in succession may be used, but the spring will have to be hooked on the outside of the sliding members of the toe-in gage.

The gage can be used on all trucks including the jeep.

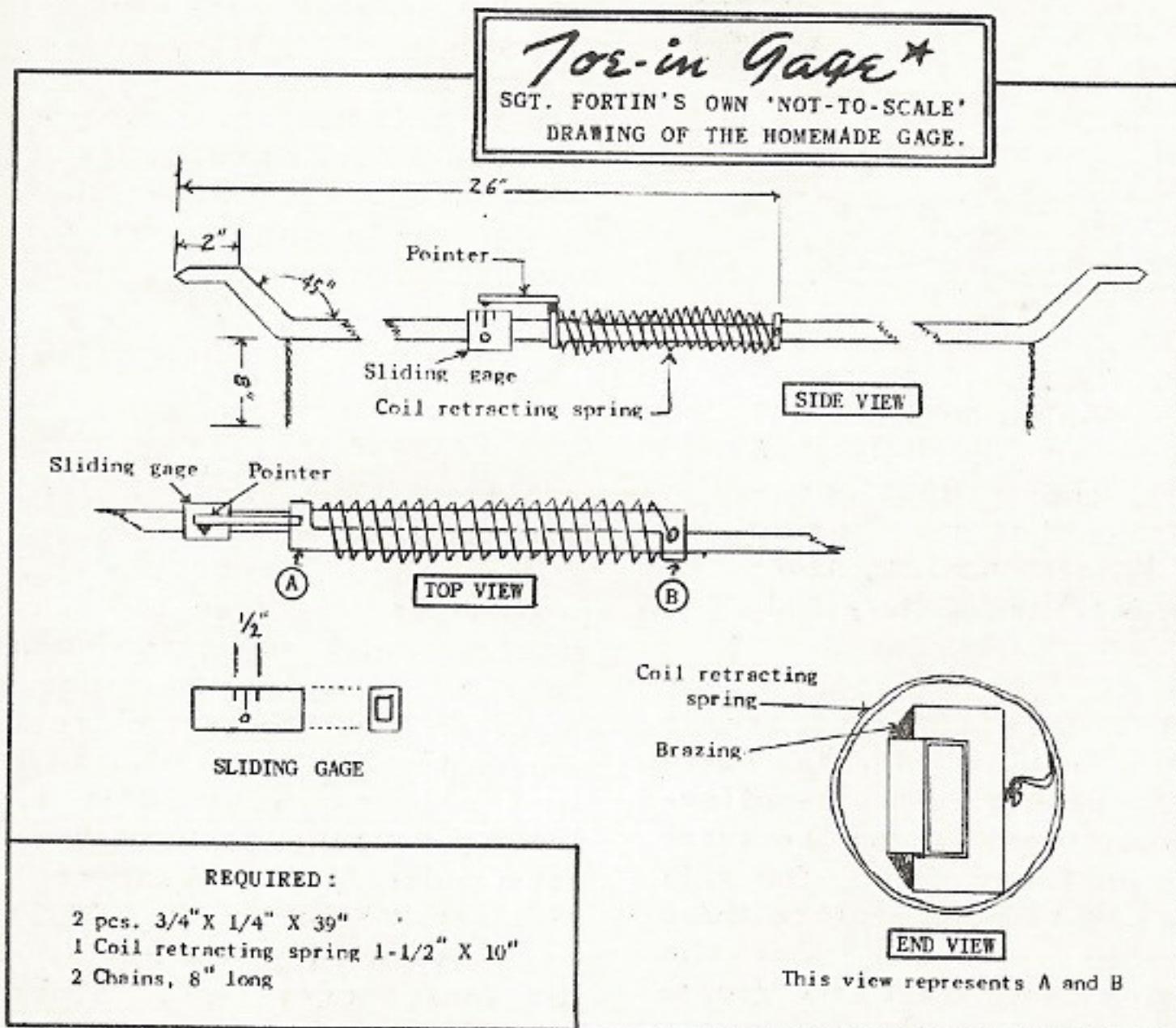

Sergeant Crogan

OF ATLANTA, GEORGIA

Here we are with our editorial tongue hanging out because you forgot to include your address in your letter. Having just returned from overseas, you can undoubtedly give us plenty of information on how your 3rd-echelon shop functioned on foreign shores.

How about it, Sarge?

The Editor

INTERCHANGEABLE GASKETS

Automotive Advisor Jesse Edwin Davis at Fort Benning offers an interchangeability note:

"All gaskets used on the T-203 1½-ton Dodge engine are exactly like those on the T-118 Chrysler Industrial engine that powers Hobart Electric Welders."

Therefore, set #951273 is the one to order when you need gaskets for either job.

Now that we've given you one, how about sending us your favorite deadline-cheater? Address: The Editor, Army Motors.

Letter of The Month

Dear Editor,

I wish to thank you for renewing my subscription to ARMY MOTORS and to let you know that I haven't missed a copy of your very fine magazine yet.

I'd like to make a suggestion that does not involve a single ounce of vital materials or any change in the design of the vehicles:

In order to make it easier to figure up logistical data, why not add the shipping tonnage and cubic volume of each vehicle to the data plate on each motor vehicle and trailer. I know there's a certain book that's supposed to give all that, but have you taken a look at one lately? Several vehicles are not listed, especially late models and types.

I was very much interested in the article on the new open-cab models in the October number of the Army Motors. As I looked at the pictures I wondered if you wouldn't soon be running a gunnery course for assistant drivers in your schools. As I see it, the assistant driver won't get so much sleep on convoys anymore, and it'll stop noncoms from pulling their stripes on the assistant driver to get a seat in the cab. It'll also stop the beefing that usually goes on from the rear about the driver and the guy who rides with him having "the best go". These things are by-products, like fertilizer at a packing plant.

I also notice that you have traded your wheel, key and saber for a flaming bomb. The main thing I noticed was that your policy is going to continue just about as it always has. If anyone tries to lay a hand on the publishing of the magazine, tell them that it is vital to national defense, and you won't have to look down your nose when you say it.

A happy new year to all of you.

W.O. (J.G.) Norman E. Runyon
203rd Coast Artillery (AA)

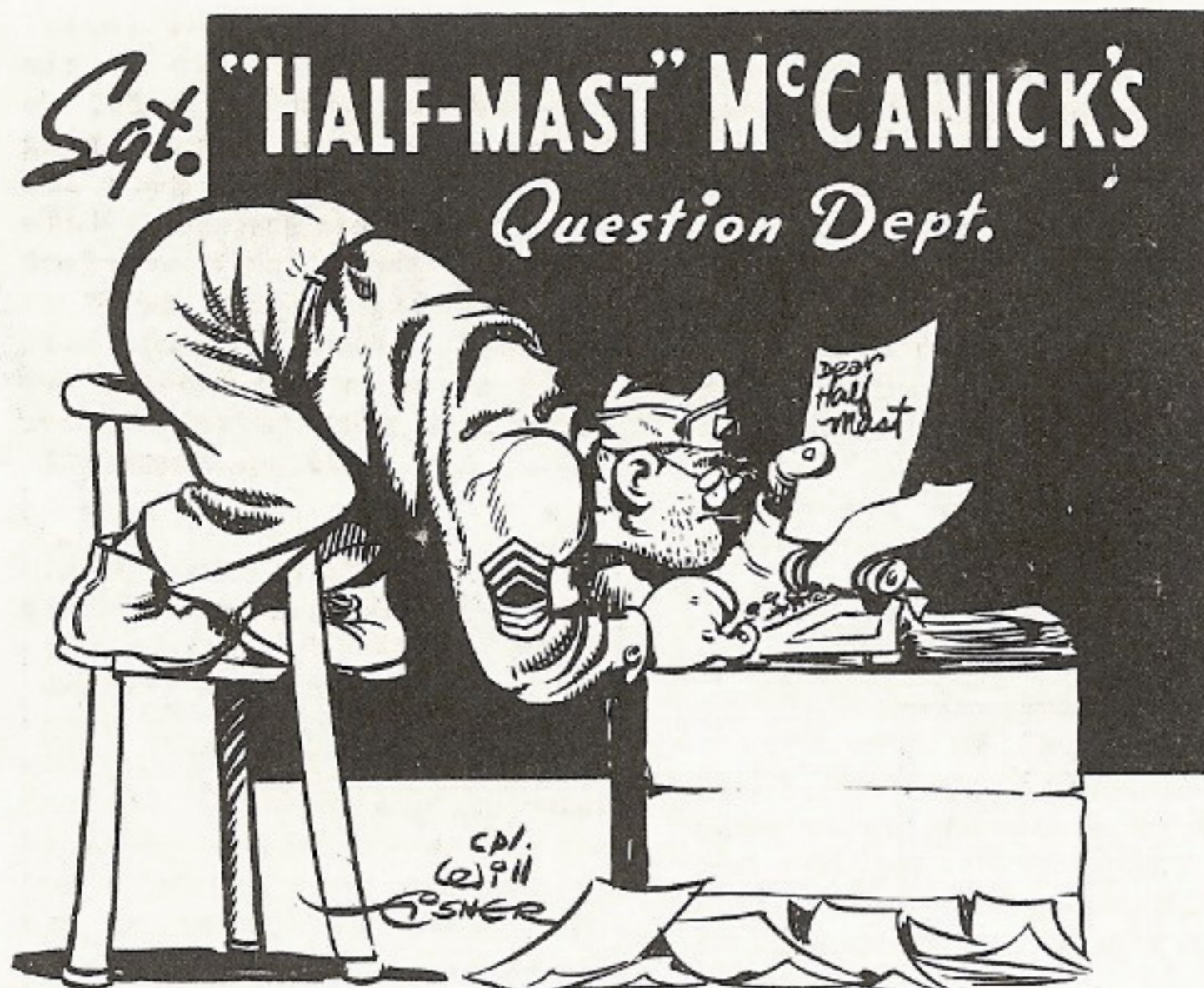

What Half-Mast doesn't know you could put in a gnat's ear and, by the same token, what a gnat doesn't know you could put in Half-Mast's ear. Half-Mast is the answer man, he'll answer all those questions - technical, procurement, procedure - that have you up a tree. Write "Dear Half-Mast," Maintenance Engineering Unit, Holabird Ordnance Base, Baltimore, Maryland.

Dear Half-Mast,

I have trouble keeping grease in the spline joint on the front drive shaft on 3/4-ton Dodges. The spline joint is next to the muffler and the heat melts the grease, while the constant rotation throws out the melted grease. This causes wear and heating of the spline joint. What's the solution?

Lt. W.E.H.

Dear Lieutenant,

I don't think the muffler heat has a lot to do with your trouble. The joint would be much more likely to pick up heat from the transfer case than from the muffler. The muffler is not in actual contact and has an air stream passing by when the vehicles are under way.

The real difficulty probably lies in 1) frequent and

lusty application of grease to the fitting which has blown out the propeller-shaft-spline-yoke dust washer and 2) natural wear on the washer. You will probably have to replace these washers, and instruct the parties charged with the grease gun to go easy on the lubrication. Few mechanics realize that they can build up enough pressure with a hand gun to lift the truck.

Over-lubrication can cause as much trouble as under-lubrication. So lubricate the fitting on the slip joint carefully until the grease just begins to show and see if it doesn't lengthen the life of the washer.

Half-Mast

Dear Half-Mast,

I've got a couple of tools to mention which I've made

plenty use of in civilian life, but am sorry to say I've never seen them in the army.

They are the terminal puller and the terminal stretcher pliers. Nine out of every ten batteries are ruined by just using a screwdriver to pry off the cable terminal from the post, causing the screwdriver to dig in and crack the battery.

Then when the cable is put back on the battery lug, the terminal isn't opened enough - somebody grabs a hammer, gives it a few whacks and you get the same results as using a screwdriver.

My boss in civilian life used to tell me to use my head instead of a hammer, so I pass on the suggestion that we use the proper tools and have less breakage.

P.F.C. M.J.B.

Dear Private,

Well, I'm sure glad to hear from somebody who gives a damn about batteries. I personally have seen too many that got just about the same care as daddy's old truss. However, about those two tools you mentioned - if you'll look in the latest list (Oct. 1, 1942) of Ordnance hand tool sets under 'Battery Experts' tool set, (Stock No. 41-T-3505) you'll see a 'Puller, battery-terminal, screw-type,' Stock No. 41-P-2900.

Now, if you're a battery expert (you forgot to tell me in your letter) you're entitled to this puller, and if you don't have it, you ought to soon get it. But if you're a driver or maybe a 2nd-echelon mechanic, you're not entitled to it because the powers-that-be figger that you don't have enough use for it. Of course, you and me both know there are times when you have to take the cable terminal off - so the only thing I can tell you and everybody else is to take a lot of care. Loosen the cable-terminal nut well and if you have to use a tool

to pry it up, shove a little piece of wood or something under the point of contact so it won't dig into the battery case.

However, if I were you, I'd avoid taking off the terminals as much as possible. I wouldn't take them off every time I wanted to clean away the corrosion. I find that hot water washes away corrosion - and even cold water'll do - just douse it on (being careful that the filler caps are in place).

About those terminal stretcher pliers: yes, we don't have any. All of our positive posts are of a uniform size and fit all positive battery-cable terminals. So there's seldom need to stretch them unless you are trying to put a negative terminal over a positive post. God forbid. The same with the negative posts and cable terminals (which, of course, are slightly smaller than the positives).

But using a hammer on a battery at any time is like using a hammer on an egg - it's that fragile. As you say, anybody who feels the urge to use a hammer ought to use his head.

(By the way, these cold days we ought to be even more careful in handling batteries. The pitch sealer around the cover gets hard and cracks easily letting the electrolyte leak out.)

Half-Mast

Dear Half-Mast,

We've run into some trouble with the seals on the propeller-shaft-pinion flange and the drive flanges on transfer cases, and transmissions. It's my opinion that the hypoid lube has a chemical reaction on the leather seals, hardening them - which together with the dirt picked up in operation - forms an abrasive that wears out the metal. How about it?

Sgt. L.V.D.

Sarge, you're just another of the poor devils plagued by dirt getting into those seals which are more or less exposed, ruining them and tending to score the metal parts in the neighborhood. It's a big problem, especially on the desert or in other dusty areas, and the only answer I know, is twofold: (1) wipe all dirt away from around the seals and nearby parts after every operation in sandy or dusty areas; (2) install sand slingers wherever authorized. For instance, TSB I-8 suggests that sand slingers (Part No. GMC-2155004) be installed at the universal joints on both ends of the transfer cases of the GMC 2-1/2 ton, 6x6, with split-housing-type axles ACKW-352-3; and on Studebaker 6x6.

Incidentally, if the winch is being used, you'd better include a frequent wiping of the winch shift rail in your after-operation schedule.

* * * *

Another thing, Half-Mast, on our Chevies and GMC's we've had trouble with wear in the tie-rod ends. Now since there's a bronze bushing on the steering arm to prevent wear, why isn't there a bushing on the tie-rod end to prevent wear there?

Well, Sarge, there's no bushing in the tie-rod end (the yoke) because the tie-rod end is not supposed to be in motion and doesn't need a bearing surface. If you find these tie-rod ends jiggling around and wearing, then you do indeed have trouble. The bolt holding the tie-rod end to the steering arm is supposed to be tight in the tie-rod end and is kept tight either by serrations under the head of the bolt or by a jamb nut under the lower part of the yoke. If there is play between the tie-rod end and the bolt, there will surely be wear on the tie-rod end and once it's worn, the best thing for you to do is change it.

One way to prevent looseness between the yoke at the tie-rod end and the bolt, is to be sure that the bushing in the steering arm gets its full quota of grease. Make sure your boys don't overlook the fitting in the head of the bolt. That way, the bolt won't seize in the bushing and force the yoke to work loose from, and ride on the bolt.

* * * *

As a parting shot, Half-Mast, we are experiencing quite a bit of trouble with the hoods on our jeeps cracking near the hinge. Isn't there some way of fastening the rear of the hood to prevent the vibration which seems to be causing the cracking. And that damn rear panel on the jeeps is ripping out because of the weight of the rear tire and also vibration. What about that?

The hood cracking first of all, is one of those chronic troubles that nobody has ever taken the time to really solve. Oh, they did make the hinge leaves of a heavier gage metal and they also put a couple of blisters underneath and out near the ends of the hood to give additional points of support - but the last I heard, the hoods were still cracking. The hood cracks and the boys weld it up, the welds crack and the boys weld up the welds - like putting a splint on a crutch. So you and me both Sarge, are still waiting for somebody to work out a really good way to keep the hood from cracking.

Same with that rear panel on the jeep - the weight of the tire and the vibration cracks it out. The solution to that might be a little simpler; as a matter of fact in the November Army Motors 'Contributions Dep't', Lieut. J. E. Winters suggests, "Remove the tire rack, drill and bolt two 20-inch lengths of 1/2 x 1-1/4 inch angle iron between the rack and the end gate. The angle iron gives the rack a more substantial

foundation so it won't pull the metal out of the end gate." You try it, Sarge.

Half-Mast

Dear Half-Mast,

They've got me running around in circles. First, it's use the mud-and-snow-tread tires, then it's take 'em off and put on the highway-tread-design tires...then it's back to the mud-and-snow treads. Please, can you give me a ruling on this, so I'll know where I stand?

Capt. J.E.C.

Dear Captain,

Leave me put your mind at ease, sir. Just follow my finger which is pointing to War Department Circular 384, November 27, 1942. It says "Army vehicles will be equipped with tires of mud-and-snow-tread design, except for the following vehicles which will be equipped with tires of highway-tread design: (1) All vehicles operating in Puerto Rico and Panama, and within the continental limits of the United States, except

Alaska, until existing stocks of tires of highway tread design are exhausted."

Also, passenger sedans, motorcycles, and vehicles using sizes of tires not available in mud-and-snow treads will use highway-tread-design tires.

And, if you're jockeying a earth-moving job, a road-grader, or some similar special-purpose vehicle which needs special-purpose tires, naturally, you'll use the special-purpose tires it needs. If you're operating over roads that make mud-and-snow-tread tires necessary for safety and mobility, why, go ahead and use mud-and-snow treads on them.

Speaking of tires, Captain, elsewhere in this issue, you'll see a story on the demounting of the combat wheel which we hope will cut down the mortality of combat wheel tires.

Half-Mast

Dear Half-Mast,

What's the score on these Chev transmissions? Some have forty-two teeth on first gear sliding; some forty-three.

To the
"200 lb. Country boy..."

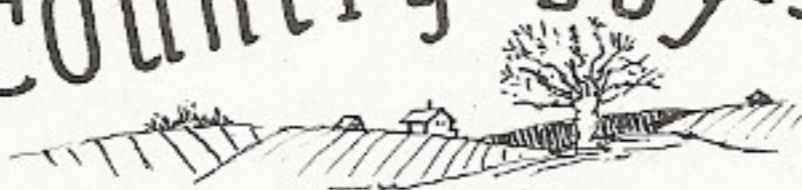

who wrote me a letter on Forrest Hotel, Hattiesburg, Mississippi, stationery: Maintenance Manuals may be obtained through channels. We believe the fastest way is to have your company commander requisition manuals from the Adjutant General's Depot in your area. Overseas units will probably have to requisition these manuals through their Port of Embarkation.

Technical Service Bulletins, for the time being, can be obtained from the Maintenance Engineering Unit, Holabird Ordnance Base, Baltimore, Maryland. A new set-up is planned for the future, however, and we'll give you the dope on it as soon as it goes into effect.

Half-Mast

Most of the transmissions that we repair have just forty-two teeth.

Now my question is, how many different models of transmissions are there and what parts are interchangeable between them?

I can't find anything in any of the maintenance manuals that might help. Hope you can help us out on this deal.

Sgt. H. H.

Dear Sarg,

Answering your first question, "How many different models of transmissions does Chevy use?" A quick look at the Master Parts Book shows seven transmissions used in all Chevrolet models. Your second question, "What parts are interchangeable?" is unfair to organized labor and would drive me crazy trying to find out. However, what you say in your letter leads me to believe that you are mainly interested in the 4-speed transmissions used in the 1-1/2 ton Chevy. According to the Master Parts Book, all parts in the 4-speed transmissions are interchangeable with the exception of the following parts:

- Hand brake lever
- Pawl rod
- Reverse latch rod
- Shift lever
- 1st and 2nd speed gear
- U.J. flange
- Bearing retainer
- Retainer gasket
- Counter shaft cluster

Now about the teeth on the first gear sliding: As you say, some have 42 teeth and some 43. Don't let this bother you, it only represents a difference in gear ratio among the 4-speed transmissions. But you'll be perfectly sure to get the right gears in the right place, by counting the teeth on the first gear sliding and also on the cluster gear that the sliding gear meshes with. If the first gear sliding has 43 teeth, the cluster gear it meshes with must have 14 teeth.

(Continued on page 316)

DEAD STORAGE

(Continued from page 285)

accurate facsimile - remove the spark plugs and, taking one at a time, get each piston down at the bottom of its stroke. Spray the inside of the cylinder with about 1/8 of a pint (2 ounces) of the preservative oil. In order to guarantee that you'll apply only the specified amount of preservative oil, load the spray gun with an eighth of a pint for each cylinder. Be sure you coat the entire surface of the cylinder wall, piston head and valves (including the valve faces).

Follow this first spraying by turning the crankshaft over twice, then respray each cylinder with half as much of the oil as you used the first time.

If you don't have a spray gun, an alternate method of applying the oil is allowed. Start the engine and run it about 1000 rpm's. Pour a pint of the preservative oil through the carburetor air intake (or through a suction connection into the intake manifold), as fast as possible without stalling the engine. The temperature of the oil and the engine must be above 60°.

With the ignition off, open the throttle to 'full' position and turn over the engine four or five times with the starter. This will push out the burned exhaust gases which are corrosive if allowed to stay in the engine.

These same corrosive exhaust gases make us like the spray method of applying the preservative oil better.

Valve Compartment: Take off the inspection cover and clean the inside of the cover, camshaft and the valve mechanism. Spray the whole works with the preservative oil, turning the crankshaft to be sure the entire surface of the cam and the protruding ends of the valve stems are well coated. Spray the inner surface of the inspection cover and replace.

Cooling System: Drain and flush the radiator and the engine block (plus any heaters or accessories). Have all the drain cocks in the radiator and the block open to get all the water out - use your blow gun to force it out.

Openings: All openings in the engine must be protected and sealed. Coolant passages, fuel and oil line connections, cylinder ports, etc., must be coated with the preservative oil. Seal the openings with plugs, tapered enough so that they won't fall through the openings and on into the engine; or gather strong wax paper bag-shaped around the openings and tie with a string. Place a large paper bag over the air cleaner and tie it down at the bottom with a string.

Spark plugs: Remove the spark plugs, coat the holes with the preservative oil and plug up with corks, wooden plugs or unserviceable spark plugs. Clean, adjust and test the plugs taken out, coat with the preservative oil and put back in stock.

Distributor: Coat the steel parts of the distributor lightly with 'rust-preventive compound, light', (see box 1st page).

Engine exterior: Clean and thoroughly dry the outside surfaces of the engine with solvent (carefully so as not to wet electrical parts and wires). Sand off all spots where the paint has failed, and repaint. Sand all rust off unpainted surfaces and apply the rust-preventive compound. Don't allow any of the rust-preventive compound to remain on rubber or painted parts.

GASOLINE

Drain gasoline from tanks, lines, fuel pumps, carburetor, etc., otherwise gasoline will become gummy and clog these parts.

BATTERY

Remove the battery from the vehicle. Neutralize any

acid and clean up the outside of the battery with a solution of baking soda and water (1/4 lb. to a quart of water). Follow by flushing the battery case with cold water (not hot water or steam). Be sure the vents in the caps are covered during this cleaning. Uncover them after the cleaning.

Clean, scrape and coat battery posts and cable-terminal ends with light grease.

Take a hydrometer reading of the battery and if 1.225 or below, have it recharged. Place the battery in active stock with water added, if necessary, to bring the level to not more than a 1/4 inch above the plates.

Check battery while in stock to see that it never falls below 1.225. This, incidentally is enough to keep the battery from freezing in all but the severest weather. In severe weather, charge the battery up to 1.250.

CHASSIS AND BODY

Sand off all rust on painted and unpainted surfaces. Apply rust-preventive compound to unpainted surfaces; repaint the painted surfaces you've sanded.

BRAKES AND CLUTCH

Release all brakes.

Depress clutch pedal and place a small block of wood between the clutch-pedal arm and the underside of the floor boards to hold the clutch out of engagement. The block of wood should only be large enough to hold the clutch faces apart - otherwise too much strain might be placed on the clutch springs.

EQUIPMENT

Vehicles stored in the open should have equipment such as pioneer tool equipment, vehicle tools, chains, fire extinguishers, etc., removed and stored separately. The same goes for special shop trucks in storage. This is

not necessary on vehicles stored in closed and locked buildings.

TIRES

Jack up vehicles and place blocks under axles. Remove jacks. If the vehicles are stored in a location suitable for proper tire storage, the tires don't have to be removed. Just pull out nails, stones, glass, etc., lodged in the tires and remove grease spots with solvent. Keep tires away from heat and sunlight. If necessary, protect them from the sunlight with opaque paper held on with masking tape, or old tarps. Tires should be from one-half to two-thirds inflated.

If the location of the stored vehicles is not suitable for tire storage, remove them and store in accordance with instructions on page 316.

INSPECTIONS

It's not enough to place a vehicle in dead storage and just forget about it. Monthly inspections are necessary, first of all to see that light-fingered gentry have not swiped tools, equipment and even parts from the vehicles; secondly, to see that the protective measures are sufficiently preventing deterioration.

Keep a tag attached to the steering wheel and record the date of all inspections, the inspector's initials and his findings.

REPEATING TREATMENTS

Repeat the treatment for *cylinders, valve compartments, outside engine surfaces, and chassis and body*, every three months.

In salt water areas, in tropical climates or similar severe climates, you'll probably have to take stronger measures against rust and corrosion. If you find this so, repeat the treatments every month instead of every three months.

Removing from Storage

At the end of the dead-storage period, it's necessary to recondition the vehicle. Starting with the....

Cooling system: Flush the system to remove loose sediment following the directions in the maintenance manuals. Inspect and replace hose if necessary. Be sure the system is tight. Fill the water and add anti-freeze to take care of cold temperatures.

Cylinders: You'll have to remove the excess preservative oil from the area above the pistons. Do this with a hand pump if you have one, or by removing the spark plugs and turning the engine over by hand to force the preservative oil out.

Distributors: Using clean dry rags, wipe the distributor cap and housing free of dirt and contamination. Lubricate the distributor as prescribed in the maintenance manual.

Valves: Turn the crankshaft over by hand three or four times and check for proper valve operation. Inspect for any material in the cylinders which might obstruct the operation of the engine. Lubricate the stems of sticking valves with penetrating oil or a 50-50 mixture of kerosene and light lubricating oil (SAE 10). Keep turning the engine over until all signs of stickiness in the valves has been removed. If the valves are still sticky after this treatment, make the necessary mechanical repairs before placing the engine in service.

Fuel tank, Spark plugs, and Battery: Fill gas tank full, install serviceable spark plugs, and a fully charged battery.

Gear cases: Drain and flush and fill to proper level with the lubricant correct for the season.

Crankcase: Drain old oil; flush with one-half the crankcase capacity of flushing oil.

Starting engine: After preparing the vehicle, start the engine by towing with the ignition on. When the engine is running smoothly, shut off the ignition and drain the flushing oil while the engine is still warm. Fill the crankcase with the specified grade and quantity of lubricating oil.

Lubrication: It goes without saying that every part of the vehicle must be thoroughly lubricated.

Inspection: It goes also without saying that a complete inspection of the vehicle must be made. Any repairs that were needed at the time the vehicle was placed in storage, which have not yet been made, must now be accomplished.

Take special care with the following:

BRAKES (1) the linkage must be smooth working and free from restrictions due to drying-out, corrosion, rusting, etc. Check and lubricate all clevises, pins, movable joints, and cables. Check the action of return springs, and brake-actuating mechanisms.

(2) Power units: Check the operation of the safety valve on the reservoir, the functioning of the air governor and the air compressor.

(3) Vacuum booster brakes: The piston rod and the piston leather must be free-acting. The rod in the external valve must work freely and the filtering element must be clean.

WHEEL BEARINGS AND FELTS - remove the wheels, repack all oil seals and felts.

LIGHTS - Clean and polish light reflectors (except, of course, sealed beams). Check for loose or damaged gaskets.

FUEL PUMPS - Change the diaphragms on mechanical fuel pumps. If the vehicle has been in dead storage more than a couple of months, the diaphragms of electrical fuel

pumps must also be changed.

OIL FILTERS - Change the oil-filter element on vehicles which were in service before being placed in storage.

VENTS - Free up all vents (in fuel tanks, hydraulic-brake master cylinders, etc.).

Preparing vehicle for service is as important as preparing them for dead storage. Stay close to the check list and do the work thoroughly.

Storage of Parts and Equipment

Engines to be stored must never be allowed to rest on their oil pans. Put them in racks or frames. Clean and paint the outer surfaces with gray heat-resisting paint except as follows: (1) Engines received from manufacturers in their standard colors, don't have to be repainted until repainting becomes necessary for the protection of the engine; (2) Engines furnished unpainted, must remain unpainted.

Protect engines with the same treatment specified for engines of vehicles placed in storage; follow up with the same periodic re-treatment, and take the same special precautions for unfavorable climatic conditions.

Tag each engine and write on tag as much of the following information as needed for local reference:

- (1) Name of vehicle from which engine was removed or for which built.
- (2) Name of manufacturer of engine.
- (3) Bore or stroke.
- (4) Manufacturer's type or symbol.
- (5) Manufacturer's serial number.
- (6) Government purchase number if purchased as a separate unit.
- (7) U.S.A. number of vehicle from which removed.
- (8) Date placed in storage.
- (9) Condition: As new stock, rebuilt, overhauled, needs repair of ___ parts, missing parts _____.
- (10) If O.K. (as new or rebuilt), initials of inspector and dated.

(11) Dates of subsequent periodic inspections and initials of inspectors.

(12) Any other information likely to be desired.

Transmissions, transfer cases, differentials, and axles - Clean these thoroughly inside and out; slush the inside with the preservative oil; either paint the outside or slush with the preservative oil. Tag each unit with a tag bearing the following information:

- (1) Name of vehicle from which unit was removed or for which built.
- (2) Name of manufacturer.
- (3) Gear ratio (if driving axle).
- (4) Manufacturer's type or model symbol.
- (5) Manufacturer's serial number.
- (6) Government purchase number if purchased as a separate unit.
- (7) U.S.A. number of vehicle from which removed.
- (8) Date placed in storage.
- (9) Condition: As new stock, rebuilt, overhauled, needs repair or replacement of ___ parts, miss-

One May Be Enough!

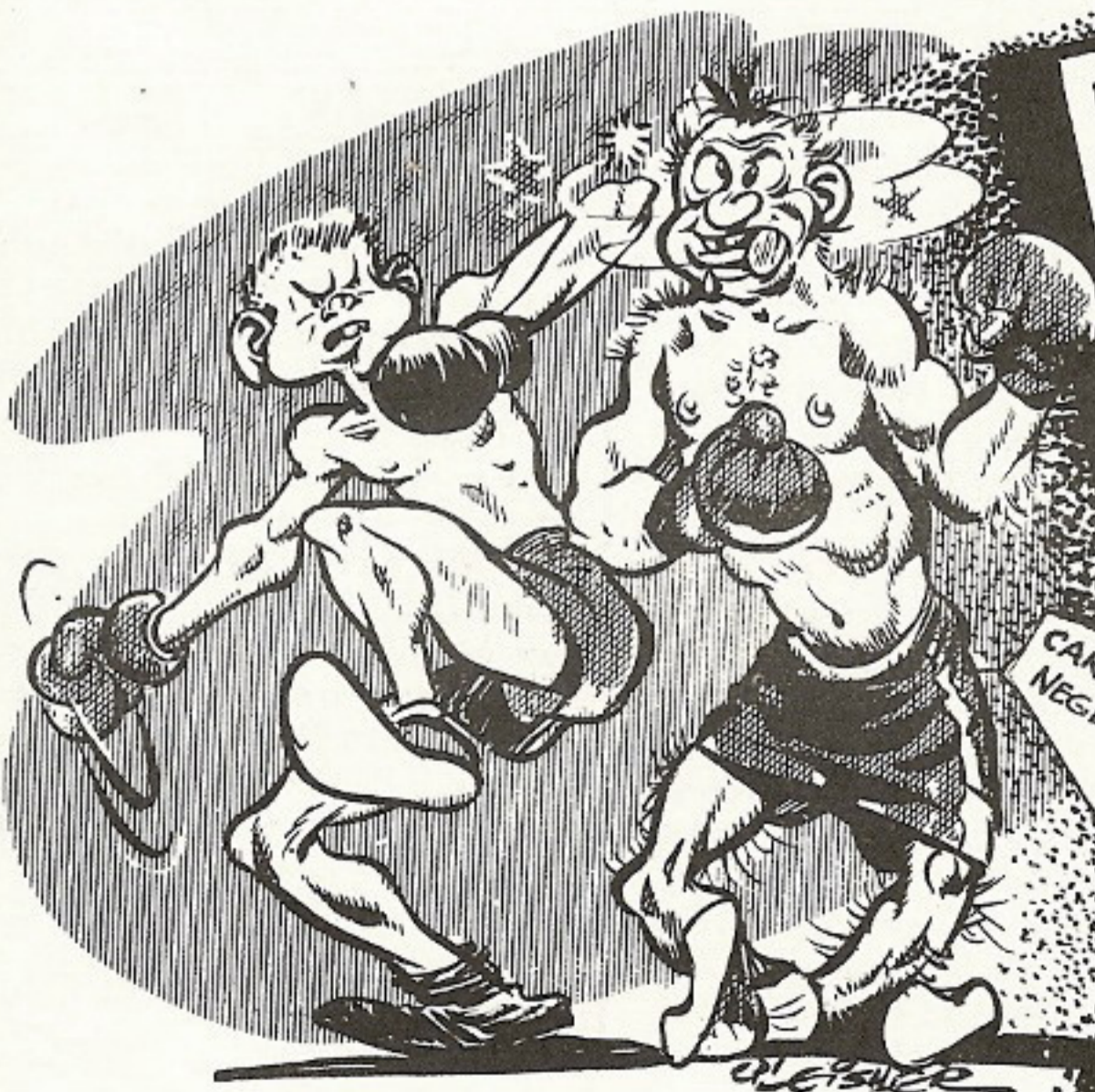

IF ² JOE DOPE POSTERS ARE BEING USED WHERE ONE IS ADEQUATE, DON'T HANG UP JOE DOPES JUST BECAUSE THEY LOOK NICE.
JOE MAY BE NEEDED SOMEWHERE ELSE!

CHECK YOUR DISTRIBUTION

Notify your post Commanding Officer if your outfit is not receiving proper consideration or distribution. A distribution list has been drawn up to include all posts, camps, stations, and air bases and fields in the United States and possessions; including all APO numbers we know of. The local distribution is left to the post Commanding Officer. Get your outfit's name on his list.

ing parts.

(10) If O.K. (as new or rebuilt), initials of inspector and date.

(11) Dates of subsequent periodic inspections and initials of inspectors.

Electrical Units - If subject to rust or corrosion, place them in waterproof paper containers. Tag each unit and write in a full description.

Wet Batteries - No battery should be allowed to fall below 1.225. Dry batteries should be stored dry in accordance with manufacturer's instructions.

Tires and tubes - If serviceable, store them under cover. At no time will serviceable tires and tubes not mounted on vehicles be stored in the open. Light is destructive to rubber, therefore, the windows of buildings in which tires and tubes are stored must be protected from light penetration. Paint windows sun-resistant green or with blue paint.

Excessive heat is also destructive to rubber. The best temperature is between 32° F. and 80° F. Keep tires and tubes out of strong air currents, dampness and dirt. Protect them from oils, greases, gasoline, and from hot surfaces. Don't store them in rooms where electric generators or battery chargers are operated.

Stack tires horizontally in piles except where racks for vertical storage are available. Group them according to size. Piles of tires 7.50-20 and larger shouldn't be stacked higher than 12 feet.

Store new tubes in their original containers, grouped according to sizes and types.

Used tubes must be deflated and rolled so that there are no sharp creases, and placed in bins according to sizes and types.

Clean, roll, and properly identify used flaps and place in bins.

Tools and parts subject

to rust or corrosion, must be covered with a light coat of the preservative oil, and tagged. Give special attention to exposed finished parts or assemblies.

All that we have said about storing vehicles, holds also for special-purpose and plant motor vehicles. Certain other instructions for storage may be found in the maintenance manuals pertaining to these vehicles.

DANGEROUS AIR

(Continued from page 306)

the other. The holes that appear in the element as a result of this action, make it next to useless.

The hurry-up Harry's are still another variety of air-gun addict. Dissatisfied with the law of gravity as presently amended and enacted, they apply the air gun to the filler holes of various gear cases to make the pressure drain the oil faster. This is one of the quickest ways we know of to blow the oil seals. And it's entirely unnecessary because the heaviest lubricant we're using in gear cases now is 90 oil; 90 oil when warm, drains like water.

Using an air gun to blow out clogged fuel lines is an ancient and - if tactfully done - honorable practice. But what do you think of the yahoos who apply the gun to the fuel tank and build up pressure without detaching the other end of the line at the fuel pump? We get more fuel pump diaphragms blown out that way!

The bearing-spinners deserve dishonorable mention. These are the dumguards who like to see how fast they can make the balls spin with an air gun. When they've found out, they might as well throw the bearing away. An air gun can make a ball bearing spin up in the tens of thousands of rpm's and any dirt in the bearing - or even the dust in the air - acts as an abrasive which at this high speed

quickly ruins the bearing.

The list of blow-gun mal-practitioners is as long as your arm and includes the guys who use it around open engines and machinery and blow dust and dirt into close-fitting parts. And then there's that worst of the breed, the practical joker. But that seems to be the way with any good useful tool. There are always some guys who'll abuse it.

Who was it called them 'hammerheads?'

SGT. HALF-MAST'S DEPT.

(From page 312)

If the first gear sliding has 42 teeth, the cluster gear it meshes with must have 13 teeth.

In other words, you can use the gears interchangeably between these two models of 4-speed transmission, as long as you use the 43-14 ratio or the 42-13 ratio.

If you get a hold of the Chevy Master Parts Book TM 10-1475 (write to the A.G.O. through channels) I think all your Chevy transmission interchangeability troubles will be over.

Half-Mast

In the October issue I saw where Half-Mast identified the little thing that had fallen from the front of the transmission and was bouncing around in the fly-wheel housing of a jeep as an oil-retaining cup.

We have had the same trouble, and find that the new cup can be held in place by the use of a small dowel pin. We drill a small hole in the transmission housing to hold the pin, and then slot the cup so the pin will hold it. The slot in the cup is shallow of course, so it will not pass through the wall of the cup.

A.C.H.

Secretary Stimson's Message

WAR DEPARTMENT
WASHINGTON

MEN AND WOMEN OF THE ARMY OF THE UNITED STATES:

Maintenance of trucks, tanks and all the vehicles of war at a high standard of performance is as important to the success of the Army as the physical fitness of its personnel.

The Army supervises programs to insure the continuing health of its men and women. Maintenance of the same degree of perfection in vehicles depends squarely upon their crews.

Whether you are in a training camp in the United States or in the forward line of a combat area, "readiness for battle" must be the standard by which you judge the condition of this equipment which has been entrusted to your care.

The whole long chain of production and supply--from assembly at the factory to delivery on a distant shore--is severed if a vehicle's high perfection is permitted to deteriorate through lack of responsible care.

I call on every man and woman serving with the Army of the United States to unite in a campaign of preventive maintenance designed to abolish the menace of mechanical failures and to get the most from the fine machines which industry has provided.

This is your responsibility. I depend upon you to see it through.

Henry L. Stimson

Secretary of War.

Why do they call LOOIE, DE LUG ?

This is Looie.

Looie is negotiating a 100% grade
in high gear.

Looie has a full load on his truck.
The truck is shaking like a mule
with the a-gue.

In the combustion chambers, the
explosions are pounding against
the tops of the pistons which
won't budge because of the load
on them.

Pretty soon the tops of the
pistons will bust open
from the detonation.

Inside the transmission, the
gear teeth are on the
verge of shearing off.

But this doesn't bother
Looie.

Looie is an ig-no-rā-mus.
Looie lugs a car uphill in the
wrong gear.

That's why they call Looie, de lug.



STEEP
HILL